



AUTOMOTIVE HEAVY-DUTY INDUSTRIAL

TOOLSHOP

EXPERIENCE. KNOWLEDGE. PASSION.

IR
1/2" Drive Impact Wrenches **Page 88**

- IRC-2235QTIMAX **\$659.95**
- IRC-2235TIMAX **\$599.95**
- IRC-2235TIMAX-G **\$599.95**
- IRC-2235TIMAX-O **\$599.95**
- IRC-2235TIMAX-R **\$599.95**

FREE!

While quantities last

Buy #IRC-2235QTIMAX, #IRC-2235TIMAX, #IRC-2235TIMAX-G, #IRC-2235TIMAX-O, or #IRC-2235TIMAX-R, and obtain #IRC-36QMAXB for free: 1/2" Drive Ultra-Compact Impact Wrench.

ASSOCIATED

Page 16

\$554⁹⁵

ASS-US20

6/12V 200A Fast Charger for Conventional Batteries



GRIP

\$149⁹⁵

Page 221

GRI-52240

Industrial Plastic Service Cart



ATD-5851
1/4" Capacity Air Riveter, 1/2 HP
Page 321

\$179⁸⁵

Hose Reels for Air & Water **Page 113**

Item #	Hose Size	Price
ATD-31166	3/8" x 50 ft.	\$189.95
ATD-31167	1/2" x 50 ft.	\$249.95



Page 227

ATD-3056

5 Ton Bar-Type Puller/Bearing Splitter Set

\$123⁰⁵



\$59⁹⁵

ATD-8622

10-Pc Bearing Race and Seal Driver Set

Page 345



SOLAR

SOL-ES5000 **Page 12**
12V 1,500A Jump Starter

\$217⁴⁵

BOOSTER PAC



SOL-ES1224 **Page 12**
12V/24V 3,000/1,500A Jump- Starter

\$589⁹⁵

TRUCK PAC



SOL-JNC660 **Page 12**
12V 1,700A Jump-Starter

\$231⁸⁵

JUMP n Carry



SOL-JNC1224 **Page 12**
12V/24V 3,400/1,700A Jump-Starter

\$637⁴⁵

JUMP n Carry



TRAXION
engineered products

TRX-1-100

ProGear - 400 Lbs Capacity Wide Body Creeper **Page 305**

\$199⁹⁵



GRIPEDGE
ROUNDING - EXTRACTORS - TECHNOLOGY
ALL ABOUT THE GRIP

NEW



THE ONE STOP SOLUTION for your fastener rounding prevention and extraction needs. "Grip it, don't strip it!"

Page 130

For the exclusive use of authorized dealers of G2S TOBEQ INC.

AUTEL MAXISYS



BRING YOUR BAY

TO THE MAX

ADAS BAY MAX LIFT



Designed specially for ADAS calibration, while providing safer and more efficient mechanical repair and wheel alignment in a single standard bay space.

-  ALL SYSTEMS ADAS CALIBRATION
-  MECHANICAL REPAIR
-  WHEEL ALIGNMENT

NEW
ADAS LIFT

AULAULS14ALOR1T

TURN A SINGLE BAY INTO A MAXIMIZED PROFIT CENTER



PREMIUM LIFT FEATURES

The innovative table riser, rolling jacking beams, stainless steel radius plates, runway air inflation, and LED undercarriage lighting are all standard.



DRIVE ON/OFF AND IN ANY DIRECTION

Front and rear open runways paired with the unique flush-mount H shape configuration increases floor space, allowing for all systems ADAS calibration.



AULIA900 + AULMSULTRA

A single system complete diagnostics, alignment, and ADAS workflow. One Maximized Bay.



AUTEL ACADEMY TECHNICAL TRAINING

Visit autel.com/us/academy and register today for hands on automotive diagnostic, repair, service, and ADAS instruction.

AUTEL®

AUTEL.COM | FOLLOW US @AUTELTOOLS



Ford 6.7L Power Stroke Repair Tools

- Immediate return on your tool investment by successfully repairing in a fraction of the time
- On-the-truck repair: no need to remove the intake, turbo, and exhaust manifold



\$520⁸⁵

PMX-PWP200PRO

**Fuel Injector
Removal Kit**



\$795⁸⁵

PMX-O200PRO

**Broken Fuel Injector
Hold-Down Bolt Repair Kit**



\$723⁵⁵

PMX-N200PRO

**Broken EGR
(Exhaust Gas Recirculation)
Bolt Repair Kit**



\$578⁷⁵

PMX-P200PRO

**Broken Exhaust Manifold
Bolt Repair Kit**

PMX-TOM450PROP **\$1494²⁵**

**Combo Ford + Subaru
Wheel Bearing Puller Kit**

- Pull the most stubborn wheel bearings on Ford and Subaru models
- Directly mounts to the bearing
- Individual kits also available separately



PMX-UISX310PP **\$1354⁵⁵**

Universal In-Line Pattern Broken Bolt Repair Kit

- Unmatched versatility and applications: kit conforms to any in-line bolt pattern for 8mm, 10mm, 3/8", 12mm, and Cummins ISX
- Unmatched precision: Movable bushing carriages lining up dead center every time
- Work on exhaust manifolds, oil pans, water pumps, intake manifolds, and more

PMX-TRK200MSTR **\$341⁴⁵**

Thread Repair Kit

- Restores the diameter and depth of damaged exhaust manifold threads for all 8mm x 1.25mm threads



PMX-BEKMSTR **\$204⁸⁵**

Broken Extractor Emergency Kit

- 100% carbide, machine-grade drills and mills to chew through the hardest of materials: extractors, drill bits, and welds



\$136⁵⁵

PMX-PDT250A

**1/4" Drive
Adapter**

- Delivers highest stability versus a chuck



PMX-PDT266ACC **\$257⁹⁵**

Threaded Drill Bit Accessory Kit

- Premium machine shop-grade threaded drill bits achieving peak precision in the tightest spaces



**Break the Plague of Broken Bolts with PowerTech Sets for
Exhaust Manifold Bolt Repair for Ford, GM & CDJR**

A guaranteed solution in removing broken exhaust manifold bolts anywhere on the cylinder head.



Item #	Broken Bolt Repair Kits	
PMX-PWT220PRO	Master Kit – Covers 20 Engines:	<ul style="list-style-type: none"> • Ford 4.6/5.4/6.8L Gas & 6.0/6.4L Diesel • GM LS 1999 - Current 4.8/5.3/6.0/6.2L • Dodge 5.7/6.1L
PMX-RII200PRO	FORD 4.6/5.4/6.8L Gas and 6.0/6.4L Diesel	\$549.85
PMX-MII200PRO	GM LS 1999 to Current – 4.8/5.3/6.0/6.2L	\$723.55
PMX-A200PRO	DODGE 5.7/6.1L	\$506.45

Additional exhaust manifold repair plates available for many more engine applications.



M12™ Heated AXIS™ Sleeveless Vests



Includes M12™ Battery Holder, Battery, Charger

-21 Series

\$258.45 \$258.45

Size	MEN	WOMEN
S	MLW-305B-21S	MLW-334B-21S
M	MLW-305B-21M	MLW-334B-21M
L	MLW-305B-21L	MLW-334B-21L
XL	MLW-305B-21XL	MLW-334B-21XL

- Washer & dryer safe
- Heated chest and back
- Adjustable waist to improve fit and comfort
- AXIS™ Ripstop polyester
- Abrasion, water & wind resistant
- M12™ REDLITHIUM™ CP2.0 battery: 8 hrs Low, 4 hrs Medium, 2 hrs High

M12™ Heated TOUGHSHELL™ Jackets



Includes M12™ Compact Charger & Power Source, Battery, Charging Cable & Plug

\$261.65

-21 Series

Size	BLACK
S	MLW-204B-21S
M	MLW-204B-21M
L	MLW-204B-21L
XL	MLW-204B-21XL

Size	NAVY
S	MLW-204BL-21S
M	MLW-204BL-21M
L	MLW-204BL-21L
XL	MLW-204BL-21XL

- Washer & dryer safe
- Heated chest, back, and pocket zones
- TOUGHSHELL™ stretch polyester
- Better stretch, mobility, flexibility
- Abrasion, water & wind resistant
- M12™ REDLITHIUM™ CP3.0 battery: 12 hrs Low, 6 hrs Medium, 3 hrs High



M12™ WOMEN'S HEATED AXIS™ JACKET



Includes M12™ Compact Charger & Power Source, Battery, Charging Cable

\$262.05

Size	-21 Series
S	MLW-234B-21S
M	MLW-234B-21M
L	MLW-234B-21L

- Washer & dryer safe
- AXIS™ Ripstop polyester
- Reinforced high-wear zones
- Abrasion, water & wind resistant
- Adjustable waist to improve fit and comfort
- M12™ REDLITHIUM™ CP3.0 battery: 12 hrs Low, 6 hrs Medium, 3 hrs High

HEATED GEAR



M12™ HEATED AXIS™ HOODED JACKET

- M12™ REDLITHIUM™ CP3.0 battery: 12 hrs Low, 6 hrs Medium, 3 hrs High



- Washer & dryer safe
- Fitted hood designed to be worn comfortably under a hard hat without restricting vision
- Abrasion, water & wind resistant
- Adjustable waist



Includes M12™ Compact Charger & Power Source, Battery, Charging Cable

\$280.95

Size	-21 Series
S	MLW-205B-21S
M	MLW-205B-21M
L	MLW-205B-21L
XL	MLW-205B-21XL

M12™ Heated QUIETSHELL™ Jacket



- M12™ REDLITHIUM™ CP3.0 battery: 12 hrs Low, 6 hrs Medium, 3 hrs High



Includes M12™ Compact Charger & Power Source Only

\$307.65

Size	-21 Series
M	MLW-224C-21M
L	MLW-224C-21L
XL	MLW-224C-21XL

- Washer & dryer safe
- QUIETSHELL™ stretch polyester
- Reinforced high-wear zones
- Water & wind resistant



M12™ HEATED HOODIES



Includes M12™ Battery Holder Only

\$168.45

-20 Series



Includes M12™ Battery Holder, Battery, Charger

\$206.35

-21 Series

Size	BLACK	
S		MLW-306B-21S
M		MLW-306B-21M
L	MLW-306B-20L	MLW-306B-21L
XL	MLW-306B-20XL	MLW-306B-21XL

Size	GRAY	
S		MLW-306G-21S
M		MLW-306G-21M
L	MLW-306G-20L	MLW-306G-21L
XL	MLW-306G-20XL	MLW-306G-21XL

- Washer & dryer safe
- Fleece and warm jersey lining
- Fitted hood designed to be worn comfortably under a hard hat without restricting vision
- Durable utility pockets with reinforced edges
- 53% Cotton / 47% Polyester
- M12™ REDLITHIUM™ CP2.0 battery: 8 hrs Low, 4 hrs Medium, 2 hrs High



Air/Hydraulic Jacks

Item #	Capacity	Lift Height		Weight	
		Low	High		
TBQ-TAJ40200	40/20-Ton	5.9"	16.1"	79.4 lbs	\$1651.85
TBQ-TAJ53150	50/30/15-Ton	5.9"	17"	123.5 lbs	\$2268.75
TBQ-TAJ60000	60-Ton	16.5"	40.6"	278 lbs	\$3411.35

12 Raised Panel Combination Wrench Sets



Item #	Piece Count	Size Range		
STANDARD Size				
TBQ-5116M	16-Piece	10mm – 32mm	In a Roll Pouch	\$72.05
TBQ-6014	14-Piece	3/8" – 1-1/4"	In a Roll Pouch	\$70.95
JUMBO Size				
TBQ-5110MJ	10-Piece	30mm – 42mm		\$141.65
TBQ-6010J	10-Piece	1-5/16" – 2"		\$200.65
TBQ-6004J	4-Piece	2-1/8" – 2-1/2"		\$206.65

TBQ-17392 **\$97²⁵**

9-Pc Ball Joint Service Kit

- Kit includes installation and removing adapters for 1967 to current 1/2-Ton and 3/4-Ton 4WD vehicles having the Dana 44 front axle (found on Ford, GM, Dodge, IHC and Jeep vehicles)



TBQ-17398 **\$170⁴⁵**

21-Pc Master Ball Joint Service Kit

- Heavy duty tool set removes and installs ball joints, U-joints and brake anchor pins
- Includes a C-frame press and forcing screw, as well as all of the receiver tubes and adapters necessary to work on press-fit upper and lower ball joints on most Dodge, GM, Ford and other 2WD and 4WD cars, pickups, vans and SUVs through 2006



PROFESSIONAL TOOLS & EQUIPMENT

TBQ-17244 **\$44³⁵**

10-Pc Bearing Race & Seal Driver Set

- Sizes: 1.555" (39.5mm) to 3.189" (81mm)



TBQ-12370 **\$204⁰⁵**

7-Pc Truck Hub Seal Installer Kit

- Fits the most popular sizes for Class 7 & 8 over the road trucks and trailers as well as some medium duty trucks
- Includes (5) drivers: 4-13/16" to 6"-5/16"



TBQ-10330 **\$33³⁵**

18-Pc Disc Brake Caliper Tool Kit

- Applicable to a wide variety of 2WD & 4WD vehicles
- Includes 15 adapter discs as well as left-hand & right hand thrust bolt assemblies to work on front or rear brakes



TBQ-11332 **\$55⁵⁵**

7-Pc Sensor and Sending Unit Socket Set

- A variety of sockets to replace O2 sensors, oil pressure switches, oil sender units, vacuum switches and thermal sensor switches



TBQ-34700 **\$125⁵⁵**

7-Pc Exhaust Pipe Stretcher Kit

- Use with an impact wrench to quickly stretch all pipes, including stainless steel
- Stretch pipes from 1-5/8" to 4-1/4"



SUPER PROMOS

IQv²⁰ 20V Li-Ion 1" Drive Impact Wrenches

- Loosening torque: 3,000 ft-lb
- Max. reverse torque: 2,200 ft-lb

IR Ingersoll Rand. Page 74

Item #	Anvil	Description
IRC-W9691	6"	Bare Tool
IRC-W9491-K4E	1"	Kit: (4) 20V Batteries & (1) Dual Bay Charger
IRC-W9491	1"	Bare Tool

BUY & GET



FREE!



\$50 Esso Gift Card

BUY & GET

IRC-W9691-K4E **20V Li-Ion 1" Drive Impact Wrench Kit**

- L. torque: 3,000 ft-lb
- R. torque: 2,200 ft-lb
- 6" anvil

Page 74



FREE!

While Quantities Last

IRC-2145QIMAX
3/4" Drive Quiet
Air Impact Wrench

BUY & GET

Page 89

\$928⁹⁵

ACA-1778-VXL
3/4" Drive Low Vibration
Impact Wrench
• 1,450 ft-lb



FREE!



ACA-1431
1/2" Drive
Impact
Wrench

BUY & GET

\$1130⁹⁵

IRC-2850MAX-6 **1" Drive Impact Wrench with 6" Anvil**
• 2,100 ft-lb Page 90



FREE!



\$50 Esso Gift Card

BUY & GET

Page 89

\$951⁶⁵

IRC-261 **3/4" Drive Impact Wrench**
• 1,200 ft-lb



FREE!

While Quantities Last

IRC-123MAX
.401 Air
Hammer
• Short barrel
• 5 chisels



BUY & GET

Page 90

\$1194⁴⁵

IRC-2155QIMAX **1" Drive Quiet Impact Wrench**
• 1,350 ft-lb



FREE!

While Quantities Last



TDF-213123
Rechargeable
Soldering Iron Kit

BUY & GET

Page 88

\$659⁹⁵

IRC-2235QTIMAX **1/2" Drive Quiet Impact Wrench**
• 900 ft-lb



FREE!

While Quantities Last

IRC-36QMAX
1/2" Drive
Ultra-Compact
Impact Wrench



BUY & GET

Page 89

\$916⁵⁵

IRC-2145QIMAX **3/4" Drive Quiet Impact Wrench**
• 1,350 ft-lb



FREE!



\$50 Esso Gift Card

BUY & GET

\$599⁹⁵
Each/Chaque

IRC-2235TIMAX
IRC-2235TIMAX-G
IRC-2235TIMAX-O
IRC-2235TIMAX-R
1/2" Dr. Impact Wrenches
• 930 ft-lb Page 88



FREE!

While Quantities Last

IRC-36QMAX
1/2" Drive
Ultra-Compact
Impact Wrench



SUPER PROMOS

BUY & GET

\$488⁹⁵

Milwaukee

MLW-2864-20
M18™ 3/4" Drive Impact Wrench (Bare Tool)

• 1,500 ft-lb [Page 73](#)



FREE!

While Quantities Last



February 1 to March 30 Promotion

MLW-48-11-1865
M18™ 18V XP6.0 High Output Battery, 6.0Ah

BUY & GET

\$627⁹⁵ [Page 80](#)

MLW-2880-22
M18™ 4.5" / 5" Grinder Kit
• 8,500 RPM

Milwaukee



FREE!

While Quantities Last



MLW-2821-20
M18™ Sawzall® Reciprocating Saw (Bare Tool)

BUY & GET

\$466⁷⁵ [Page 74](#)

DEWALT

DEW-DCF911P2
20V MAX® XR® 1/2" Drive Impact Wrench Kit
• 400 ft-lb



FREE!

While Quantities Last



DEW-DCBP034
20V MAX® POWERSTACK™ 1.7Ah Compact Battery

BUY & GET

MLW-48-59-1850

M18™ REDLITHIUM™ XC5.0 Starter Kit
• (1) 18V XC5.0 battery, 5Ah
• (1) 18V/12V multi-voltage charger

Milwaukee



\$238¹⁵

FREE!

While Quantities Last



MLW-2686-20
M18™ 4-1/2" / 5" Cut-Off Grinder, (Bare Tool)

AUTEL MAXISYS

BUY & GET

Passenger & Light Duty Vehicle Scan Tool Tablets



[Page 43](#)

AUL-MS906PRO



OR

AUL-MS906PROTS



FREE!

Free #AUL-BT506 with purchase of #AUL-MS906PRO.



Free #AUL-TBE200 with purchase of #AUL-MS906PROTS.



AUTEL MAXISYS

Next Generation Vehicle Scan Tool Tablets



BUY & GET

FREE!

AUL-MS909

OR

AUL-MS919

OR



AUL-MSULTRA



[Page 44](#)

Free #AUL-IR100 MaxiIRT Thermal Imaging Camera, -20°C to 450°C (-4°F to 842°F), with purchase of #AUL-MS909 or #AUL-MS919 or #AUL-MSULTRA.



BUY & GET

\$517⁷⁵ [Page 56](#)

POWER PROBE

PWP-PPKIT03S
Power Probe 3 Master Circuit Tester Combo Kit



FREE!

PWP-PPDMM
Automotive Digital Multimeter



BUY & GET

\$618⁰⁵ [Page 56](#)

POWER PROBE

PWP-PPKIT04
Power Probe 4 Master Circuit Tester Combo Kit



FREE!

PWP-PPBC101CS
The Basic 12V Circuit Tester



NEW PRODUCTS NOW AVAILABLE

\$708.95

M18 FUEL™ 1/2" High Torque Impact Wrench w/ Friction Ring Kit (2967-21F)



\$503.45

M18™ REDLITHIUM™ XC5.0 Resistant Battery Starter Kit (48-59-1852R)



\$279.95

M18™ REDLITHIUM™ FORGE™ XC6.0 Battery (48-11-1861)



\$339.95

M18™ Dual Bay Simultaneous Super Charger (48-59-1815)



A BETTER SOUND IN YOUR GARAGE

\$248.95

REDLITHIUM™ USB Bluetooth® Jobsite Ear Buds (2191-21)



\$248.95

M18™/M12™ Wireless Jobsite Speaker (2891-20)



\$399.95

M18™ PACKOUT™ Radio + Charger (2950-20)



\$198.95

M12™ Radio + Charger (2951-20)



HAND TOOLS AND ACCESSORIES CATEGORIES

\$80.85

9PC SHOCKWAVE IMPACT DUTY™ 1/2" Drive Metric Deep 6 Point Socket Set (49-66-7032)



\$30.55

6PC SHOCKWAVE IMPACT DUTY™ 3/8" Drive SAE Standard Socket Set (49-66-7035)



\$30.55

6PC SHOCKWAVE IMPACT DUTY™ 3/8" Drive Metric Standard Socket Set (49-66-7036)



\$276.15

PACKOUT™ 4 Drawer Tool Box (48-22-8444)



\$254.95

PACKOUT™ Multi-Depth 3-Drawer Tool Box (48-22-8447)



\$37.15

Low-Profile Customizable Foam Insert for PACKOUT™ Drawer Tool Boxes (48-22-8453)

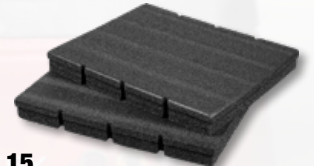

\$351.65

7PC SHOCKWAVE IMPACT DUTY™ 1" Drive MM & SAE Wheel Service Socket PACKOUT™ Set (49-66-7840)



\$256.05

38PC SAE Tap & Die PACKOUT™ Set w/ Hex-LOK™ 2-in-1 Handle (49-22-5604)



\$256.05

38PC Metric Tap & Die PACKOUT™ Set w/ Hex-LOK™ 2-in-1 Handle (49-22-5603)



NOCO CHARGERS

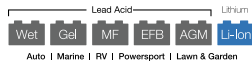

Genius® Battery Chargers™

- Charges fully drained batteries
- Maintains all battery sizes
- Spark proof technology
- 24/7 connection with zero overcharge
- Charges CANBUS systems
- Reverse polarity protection



Item #	Volts	Amps	Ah Rating (up to)	
NOC-GENIUS2	6V & 12V	2A	40Ah	\$80.85
NOC-GENIUS5	6V & 12V	5A	120Ah	\$110.75
NOC-GENIUS10	6V & 12V	10A	230Ah	\$158.25
NOC-GENIUSPRO25	6V/12V/24V	25A (6/12V) 12.5A (24V)	1000Ah (6/12V) 500Ah (24V)	\$861.05
NOC-GENIUSPRO50	6V/12V/24V	250A (6/12V) 25A (24V)	2000Ah (6/12V) 100Ah (24V)	\$1291.65

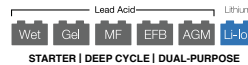

Waterproof On-Board Battery Chargers™

- **12V, 10A per Bank**
- **Force Mode** charges batteries down to 0.0V
- **Repair Mode**
- Can be mounted directly onto a variety of applications
- Reverse polarity protection
- 24/7 connection with zero overcharge



Item #	Charging Banks	Charging Current	Output Power	
NOC-GENPRO10X1	1	10A	150W	\$186.35
NOC-GENPRO10X2	2	20A	300W	\$327.85
NOC-GENPRO10X3	3	30A	450W	\$473.65
NOC-GENPRO10X4	4	40A	600W	\$619.45

NOCO Multi-Bank Chargers/Maintainers™



- **6V/12V, 2A per Bank**
- **Force Mode** charges batteries down to 0.0V
- **Thermal compensation**
- Advanced diagnostics
- Reverse polarity protection
- 24/7 connection with zero overcharge

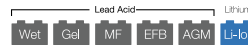

Item #	Charging Banks	Charging Current	Output Power	
NOC-GENIUS2X2	2	4A	60W	\$158.25
NOC-GENIUS2X4	4	8A	120W	\$311.95

NOCO UltraSafe® Jump Starters BOOST® – BOOST® X™ – BOOST® MAX™



Features:

- Ultra-safe, ultra-compact, rugged and portable
- Recharge virtually any USB device
- Recharge the unit from any USB port or 12V charger (included)
- Ultra-bright LED flashlight for visibility and 7 modes, including SOS and emergency strobe
- Spark proof technology
- Reverse polarity protection
- GB250, GB251 and GB500 come with a protective case



Item #	Model	Volts	Amps	Engine Type	12V Output	USB In/Out	USB-C In/Out	
NOC-GB40	Boost®	12V	1,000A	6.0L Gas / 3.0L Diesel		2.1A		\$158.25
NOC-GB50	Boost®	12V	1,500A	7.0L Gas / 4.5L Diesel		2.1A		\$233.95
NOC-GB70	Boost®	12V	2,000A	8.0L Gas / 6.0L Diesel	15A	2.1A		\$311.95
NOC-GB150	Boost®	12V	3,000A	9.0L Gas / 7.0L Diesel	15A	2.1A		\$457.45
NOC-GBX45	Boost® X™	12V	1,250A	6.5L Gas / 4.0L Diesel		2.1A	3A	\$194.95
NOC-GBX55	Boost® X™	12V	1,750A	7.5L Gas / 5.0L Diesel		2.1A	3A	\$272.95
NOC-GBX75	Boost® X™	12V	2,500A	8.5L Gas / 6.5L Diesel		2.1A	3A	\$381.15
NOC-GBX155	Boost® X™	12V	4,250A	10.0L Gas / 8.0L Diesel		2.1A	3A	\$564.15
NOC-GB250	Boost® MAX™	12V	5,250A	16.0L+ Gas & Diesel	15A	Dual 2.1A		\$855.05
NOC-GB251	Boost® MAX™	24V	3,000A	32.0L+ Gas & Diesel	15A	Dual 2.1A		\$855.05
NOC-GB500	Boost® MAX™	12/24V	6,250A	45.0L Gas & Diesel	15A	Dual 2.1A		\$1,250.05

\$15⁴⁵

NOC-NUSB211NA 10W USB Speed Charger Wall Adapter

- Fully-compatible with Noco Boost® GB20, GB40, GB50, GB70, GB150, GBX45, GBX55, GBX75, GBX155 Jump Starters and battery packs, phones, tablets, and other USB devices
- 2.1-Amp USB port for rapid charging
- Automatic shutoff protection
- USB charging cable not included



EVA Protective Cases for Noco® Boost®, Boost® X™ & Boost® MAX™



Item #	Compatible with:	
NOC-GBC013	GB20, GB30, GB40	\$30.85
NOC-GBC014	GB70	\$46.35
NOC-GBC015	GB150	\$54.05
NOC-GBC017	GB50	\$38.65
NOC-GBC101	GBX45	\$38.65
NOC-GBC102	GBX55	\$46.35
NOC-GBC103	GBX75	\$54.05
NOC-GBC104	GBX155	\$61.85



NOC-GBC005 **\$655⁸⁵**
Commercial-Grade Boost® Max™ Battery Clamps
 • Compatible with camlock connectors on Boost® Max™ GB500
 • 72" long cable, 2/0 AWG



Engine Starting Systems



Lightweight Start-All® Jump Starters & Power Packs

- Power ports for #JP-12-2500:
(1) 120V 200W A/C, (1) 12VDC, (4) 2.1A 5V USB, (2) 6mm 12V
- Power ports for #JP-12-5000 & #JP-12-10000:
(2) 12VDC, (2) 2.1A 5V USB, (1) 6mm 12V
- Power ports for #JP-12-24:
(1) 4A 12VDC, (2) 5.5mm 4A 12VDC, (1) USB-C input/output, (4) 2.1A 5V USB
- 500 lumen LED flashlight with SOS and strobe emergency functions

Item #	Volts	Engine	Amps	Joules ^{5S}	Weight	
GDL-JP-12-2500	12V	Up to 6L Gas & 4L Diesel	2,500	33300	4.4 lbs	\$356.25
GDL-JP-12-5000	12V	Up to 10L Diesel & Gas	5,000	66000	9.4 lbs	\$913.35
GDL-JP-12-10000	12V	Class 8/Class CE Gas and Diesel	10,000	133200	11 lbs	\$1349.75
GDL-JP-12-24	12/24V	Class 8 Gasoline/ Diesel up to 16L	10,000/ 5,000	166500	18.5 lbs	

JP-12-2500



JP-12-10000



JP-12-5000



JP-12-24



CAP-START

Cap-Start® 3,000A, 12V/24V Capacitor-Powered Heavy Duty Engine Starting System

GDL-051539	
12V & 12V/24V Starting	3,000 Amps
DC Alternator	240A 12V/24V DC
Power Source	Vanair® Super Capacitor and 14.5 HP Briggs & Stratton® Engine
Cables	30 ft. 3/0 gauge
Fuel Type	Gasoline
Fuel Capacity	Integrated 1.725 Gallon Tank
Battery	Integrated
Dimensions / Weight	21" W x 36" D x 20" H 295 Lbs



GDL-13-492-001

Super Boost-All® 12V/24V Vehicle-Mounted Engine Starter

- Power source: 2 or 4 Group 31 auxiliary batteries charged from the service vehicle's electrical system
- Cables: 25 ft. 2/0 gauge
- Clamps: 1,000 Amp



Safety technology includes protection against:
reverse polarity, low voltage, short circuit, overheat, over discharge, over voltage, and open-clamp



From Buses to Bulldozers, One Jump-Pack Starts it all.

The **Start-All Jump-Pack® 12/24V** is built to conquer any battery challenge. With 12V and 24V capabilities, it offers unrivaled power and versatility. Delivering a jaw-dropping 10,000A of starting power and an astonishing 166500 joules⁵⁵ of power.

LIGHTWEIGHT PORTABILITY

At only 18.5 pounds, this Jump-Pack is the perfect on-the-go power partner.

ADVANCED PROTECT-ALL® TECHNOLOGY

Built-in technology protects against reverse polarity, low voltage, short circuits, overheat, over discharge, over voltage, and open-clamp situations.

DEVICE CHARGING CAPABILITY

Easily charge phones, tablets, laptops, and portable gaming devices with multiple power ports.

ULTRA-BRIGHT LED LIGHT

With 500 lumens to illuminate your surroundings and SOS signal, you are ready for emergencies.



**Dual Voltage
Only 18.5 lbs.**

 **Goodall®**
By VAN AIR
We Start Engines®

Step up to the 12/24V
Lithium-ion Start-All
Jump-Pack® and unleash
the convenience, and
reliability you deserve.



Jump Starters

ES2500



ES5000

SOLAR.

BOOSTER PAC
BY BOOSTER PAC

Solar® Booster PAC® Jump Starters

- DC outlet to power 12 Volt accessories
- 1 year limited warranty

Item #	Peak Amps		Cranking Amps		Cable Length	Cable Gauge	
	12 Volt	24 Volt	12 Volt	24 Volt			
SOL-ES2500	900A	—	300A	—	21"	#4	\$221.95
SOL-ES5000	1500A	—	400A	—	43"	#4	\$217.45

JNC300XL



JNC660



JNC770R



JNC950



JNC1224



SOLAR. JUMP
n Carry.

Solar® Jump-N-Carry® Jump Starters

- DC outlet to power 12 Volt accessories
- Voltmeter feature: models #JNC660 & #JNC1224
- Dual USB outlets feature: model #JNC770R (2.1 A and 1.1 A)
- 1 year limited warranty

Item #	Peak Amps		Cranking Amps		Cable Length	Cable Gauge	
	12 Volt	24 Volt	12 Volt	24 Volt			
SOL-JNC300XL	900A	—	225A	—	27"	#4	\$154.85
SOL-JNC660	1700A	—	425A	—	46"	#2	\$231.85
SOL-JNC770R	1700A	—	425A	—	68"	#2	\$299.95
SOL-JNC950	2000A	—	700A	—	46"	#2	\$482.15
SOL-JNC1224	3400A	1700A	850A	425A	46"	#2	\$637.45



ES6000

ES1224



SOLAR.

TRUCK PAC
BY BOOSTER PAC

Solar® Truck PAC™ Jump Starters

- DC outlet to power 12 Volt accessories
- 1 year limited warranty

Item #	Peak Amps		Cranking Amps		Cable Length	Cable Gauge	
	12 Volt	24 Volt	12 Volt	24 Volt			
SOL-ES6000	3000A	—	800A	—	54"	#4	\$493.35
SOL-ES1224	3000A	1500A	750A	375A	60"	#2	\$589.95

Jump Starters



12/24V Commercial Jump Starters/Chargers

- Reverse polarity protection: model #4001
- 1 year limited warranty

Item #	Cold Cranking Amps		Internal Battery Charger	Group Battery Type	Cable Length	Cable Gauge	
	12 Volt	24 Volt					
SOL-4001	User Defined	User Defined	7 Amp Automatic	Group 31 (not included)	10 ft.	1/0	\$1031.25
SOL-HT1224AGM	1,400A	800A	7A x 2 Automatic	2 x Group 31 AGM (included)	10 ft.	1/0	

\$ While Qtys. Last



SOL-FMB1224 12/24V Fix Mount Heavy Duty Jump Starter

- 12 Volt mode: 1,800 CCA
- 24 Volt mode: 900 CCA
- The unit can be recharged with A/C current or connect permanently to the vehicle's 12 Volt alternator
- Automatic 7 Amp/3 channel battery charging system
- 16 ft. jumper cable leads • 25 ft. alternator cable
- Includes (3) Group 31 batteries
- Weight: 320 lbs • 1 year limited warranty



12V Capacitor Jump Starters

- Ultracapacitor power supply
- Heavy-duty PowerJAW™ clamps
- Internal lithium battery to charge unit
- Operating temperature range to -40F
- Includes wall charger and 12V charging cord
- 1 Year limited warranty



JNC8800



ASS-6127XL **\$1278⁴⁵** KwikStart Fully Automatic 12V All-Weather Jump Starter/Charger

- Cold cranking Amps: 1,100A
- On-board starter battery
- Monitors battery condition and maintains maximum state of charge
- Automatic 10A battery charger recharges starter battery or any on-board 12 Volt battery
- Accommodates a user-supplied Group 31 battery
- Clamps: 500A
- DC leads: 8 ft., 4 AWG



Item #	Start Assist	Cables	
SOL-JNC8550	550A	46" #4 AWG	\$336.35
SOL-JNC8800	800A	68" #2 AWG	\$392.45



ProSeries Jump Starters

- All models include a 2A external automatic charger (except #DSR119 that has a built-in charger)
- Reverse connection warning
- 1-Year warranty



DSR119



DSR114
DSR115
DSR116
DSR141



DSR128

Item #	Peak Amps		Cranking Amps	Cold Cranking Amps	Internal Battery	Power Inverter	12V DC Outlet	USB Port (2.1 Amp)	Cables	
	12 Volt	24 Volt								
SHM-DSR119	1,800 A		280 A	225 A	Maint.-Free, Sealed Lead-Acid AGM		1		#4 x 28"	\$192.35
SHM-DSR141	2,000 A		500 A	325 A	High Output AGM		1		#4 x 60"	\$315.75
SHM-DSR128	2,000 A		650 A		Li-Ion		1	2	#4 x 20"	\$434.65
SHM-DSR114	2,200 A		525 A	350 A	High Output AGM		1	1	#4 x 60"	\$320.65
SHM-DSR116	2,250 A		525 A	350 A	High Output AGM	400W (2) AC Outlets	1	1	#4 x 60"	\$388.75
SHM-DSR115	4,400 A	2,200 A	12V: 750 A 24V: 475 A	12V: 525 A 24V: 350 A	High Output AGM		1	1	#2 x 60"	\$623.05

Jump Starters / Power Banks



SHM-DSR108 **\$434⁶⁵**
**12V 450 Peak Amp Ultra-Capacitor
 Batteryless Jump Starter**

- Quick charge
- Designed for gasoline & diesel engines
- No battery inside
- Input: 12V DC 10A, 5V DC 2A
- 100% maintenance-free
- Microprocessor controlled
- Built-in voltmeter
- Override mode to start engine without any battery mounted
- Glow mode for cold start of diesel engine
- Short circuit and reverse polarity protection
- 3 ways to use:
 - Connect clamps to vehicle battery
 - Connect to vehicle's 12V DC port
 - Connect to a power bank via Micro-USB port (cable not included)
- Includes: (1) 12V DC charging cable



**12V Rugged™ 4-Cell Lithium
 Jump Starters/Power Banks**

- Safely adds a pre-charge to deeply discharged batteries for ultimate cold temperature starting
- Pre-heating technology warms battery in extreme cold
- Manual override mode
- Smart clamps with reverse polarity protection
- 100 lumens LED area light
- 36" cable, 8 gauge
- Input ports: 12V and 2.0A USB
- Output port: 2.4A USB



Item #	Amps	Jump Starts per Charge	Engine Type	Internal Battery	
SHM-SL1647	1,000A	25X	6L Gas / 3L Diesel	29.6 Wh	\$261.95
SHM-SL1649	1,500A	35X	8L Gas / 6L Diesel	37.0 Wh	\$270.75
SHM-SL1651	2,000A	45X	10L Gas / 8L Diesel	44.4 Wh	\$290.85



SHM-SL1452 **\$236²⁵**
**2,000 Amp Advanced 16V 4-Cell
 New Generation Lithium Technology
 12V Jump Starter/Power Pack**

- 50X jump starts per charge
- Engine size max: 10.0L gas or diesel engine
- 59.2 Wh internal battery
- Pre-Boost Technology for cold temperature starting
- 2.4A and 3.0A USB ports
- 10W wireless charging capability for your mobile device
- 14" Spark resistant smart clamps
- Reverse polarity protection
- 100 lumens 3-mode built-in LED light



SOL-JNC325 **\$279⁶⁵**
**12V Lithium Jump Starter/
 Power Bank**

- Starting Amps: 450A
- Capacity: 74Wh • (2) USB outlets
- 24" 6 AWG cables • LED flashlight
- Able to start totally dead batteries (0.0V)
- Start most V8 vehicles – 8.0L Gas/6.0L Diesel
- Includes AC charger, USB charging cable and 12V female adapter
- Reverse polarity, over-voltage, over-current and short circuit protection



CAL-550 **\$235³⁵**
**12V BOOST Li-Ion Jump Starter &
 Portable Power Unit**

- 1,000 peak Amps
- Starts up to a 6.0L gas & 3.0L diesel engine
- Includes a 10W wireless charging dock
- Inputs: 5V/2A, 9V/2A
- Outputs: USB 5V/2.1A, USB 5V/3A, 9V/2A, 12V jump starter
- Bright, multi-function LED flashlight



CAL-560 **\$328⁵⁵**
**12V BOOST MAX Li-Ion
 Jump Starter & Portable Power Unit**

- 2,500 peak Amps
- Can jump start up to a 9.6L gas and 7.0L diesel
- Outputs: 5V/1A-2.1A + 12V jump starter
- Dual USB port



CAL-590 **\$494¹⁵**
**12V Boost Ultra Li-Ion
 Jump Starter & Portable Power Unit**

- 4,000 peak Amps
- Can jump start large diesels and high-compression gasoline engines
- Charges phones and electronic devices
- Inputs: Type-C 5V/2A, 9V/2A
- Outputs: USB 5V/2.1A, 5V/2A, 9V/2A, 12V/1.5A, DC 15V/10A
- Integrated LED work light/flashlight



MLW-2846-20 **\$103³⁵**
**M18™ Top-Off™
 175W Power Supply**

- Works with any M18™ battery and delivers faster simultaneous power to personal devices and small electronics
- Quickly charge up to three devices at the same time
- (1) 175W AC 120V outlet, (1) 45W USB-C PD port, and (1) 2.4A USB-A port
- Battery not included



Boosters

Boosters

- Transistorized voltage control delivers up to 600A @ 12V mode
- 35-foot jumper cables
- Instant power at the push of a button
- Weather proof (all models)
- Reverse polarity protection (all models)
- Over voltage protection (#737 & #767)
- 1-year limited warranty

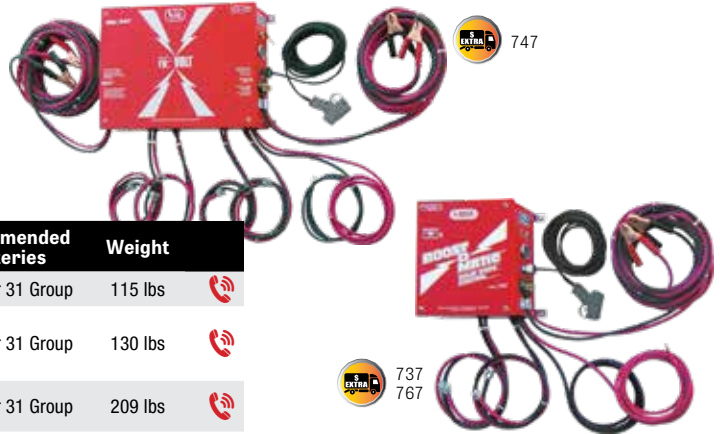

Item #	Modes	Applications	Recommended Batteries	Weight
REI-737	1-Mode: 14V Automatic	All types of cars	(2) 8D or 31 Group	115 lbs
REI-767	3-Mode: 12V Direct 14V Automatic 12 & 24V Direct	Cars, light trucks & medium construction machinery	(2) 8D or 31 Group	130 lbs
REI-747	2-Mode: 12 & 24V Direct	Every type of combustion vehicle with 12V or 24V starter	(4) 8D or 31 Group	209 lbs

Booster Cables/Clamps



401252
422252



402252



Single Booster Cables

- Operating temp.: -40°C to +80°C
- 1 year limited warranty

Item #	Cable Gauge	Clamp Type	Cable Length	Clamp Amps	
SOL-402252	2	Parrot	25 ft.	600A	\$115.25
SOL-422252	2/0	Heavy Duty	25 ft.	800A	\$300.95
SOL-401252	1	Heavy Duty	25 ft.	800A	\$155.75



REI-800PN **\$93.65**
800 Amps Super Heavy Duty Booster Clamps



Booster Cables

- 100% pure copper and PVC cables
- Tangle-free, flexible in cold weather



Item #	Wire Gauge	Length	Clamp Rating	
ATD-7972	4 Gauge	16 Feet	400 Amp	\$208.65
ATD-7974A	4 Gauge	25 Feet	600 Amp	\$458.65
ATD-7975A	2 Gauge	20 Feet	600 Amp	\$515.25

7972



7974A

7975A

Heavy Duty Booster Cables

- Copper clad aluminum cables
- Tangle free cables remain flexible to -40° F

Item #	Wire Gauge	Length	Clamp Rating	
ATD-79700A	4 Gauge	16 Feet	600 Amp	\$83.55
ATD-79701A	4 Gauge	20 Feet	600 Amp	\$97.75
ATD-79702A	2 Gauge	20 Feet	600 Amp	\$132.55
ATD-79703A	2 Gauge	25 Feet	600 Amp	\$138.15
ATD-79704A	1 Gauge	25 Feet	800 Amp	\$219.55
ATD-79705A	2/0 Gauge	25 Feet	800 Amp	\$382.15



79700A/79701A
79702A/79703A

79704A
79705A

Replacement Clamps

- For booster cables or battery chargers
- Sold in pairs

Item #	Clamp Rating	
ATD-7976	500 Amp	\$13.75
ATD-7978	500 Amp – Parrot Jaw	\$14.65
ATD-7979	600 Amp	\$29.75



7976



7978



7979

BATTERY SERVICE

Battery Chargers



Battery Chargers

Item #	Battery Voltage	Description	Re-Flash Power Supply Mode	Crank Assist	Continuous Charging Rate	Memory Saver Mode	Battery Types	
ASS-ESS6007B	12V	Intellamatic® Smart Charger/Analyzer with Re-Flash Power Mode	45 Amp	130A	45A		Conventional, AGM, Gel-Cell	\$1054.85
ASS-IBC6008	12V	Intellamatic® Smart Charger/Analyzer with Re-Flash Power Mode	70 Amp (Adjustable Voltage)	270A	60A		Conventional, AGM, EFB, Li-Ion, Gel-Cell	\$1617.95
ASS-ESS6008MSK	12V	Intellamatic® Smart Charger/Analyzer with Re-Flash Power Mode • 12V Memory Saver Port • Includes 12 ft. OBDII Cable	70 Amp	270A	60A	YES 10A/15A Port	Conventional, AGM, Gel-Cell	\$1496.15
ASS-IBC6008MSK	12V	Intellamatic® Smart Charger/Analyzer with Re-Flash Power Mode • 12V Memory Saver Port • Includes 12 ft. OBDII Cable	70 Amp (Adjustable Voltage)	270A	60A	YES 20A Port	Conventional, AGM, EFB, Li-Ion, Gel-Cell	\$1824.55
ASS-US20	6/12V	Fast Charger – VALUE LEADER • 90 Minute Timer		200A	40/40/10A		Conventional	\$554.95
ASS-6012AGM	6/12V	Heavy Duty AGM-Safe Fast Charger • 120 Minute Timer		250A	70/60A		Conventional, AGM	\$828.65
ASS-6009AGM	6/12V	Heavy Duty AGM-Safe Fast Charger • 120 Minute Timer		265A	70/60/2A		Conventional, AGM	\$956.15
ASS-6001A	6/12V	Heavy Duty Fleet Charger		375A	100/75A		Conventional	\$1294.15
ASS-ESS6011	12/24V	Intellamatic® Smart Charger/Analyzer with Re-Flash Power Supply	70 Amp	200A	70/35A		Conventional, AGM, Gel-Cell	\$1300.05
ASS-MIL6011	12/24V	Intellamatic® Smart Charger/Analyzer with Re-Flash Power Supply • Includes 13 ft. Cable with NATO Plug	70 Amp	270A	70/35A		Conventional, AGM, Gel-Cell	\$1920.95
ASS-6010B	6/12/24V	Heavy Duty Portable Fast Charger • 120 Minute Timer		230A	60/60/30A		Conventional	\$860.65
ASS-6006AGM	6/12/24V	Heavy Duty AGM-Safe Fleet Charger • 120 Minute Timer		280A	70/65/30A		Conventional, AGM	\$1051.85
ASS-6002B	6/12/18/24V	Heavy Duty Fleet Charger		400A	100/80/50/40A		Conventional	\$1528.75

Battery Chargers

Manual Battery Chargers/Engine Starters for Rugged Use



	SHM-DSR139	SHM-SC1445	SHM-SC1437
Voltage Setting	6/12V	6/12V	12V
Engine Start (12 Volt)	225A	250A	150A
Boost Mode	50A / 25A (12V) 25A (6V)	50A / 25A (12V) 25A (6V)	25A
Charge Rate	10A (12V)	10A (12V)	6A
Timer	135-Minute	135-Minute	135-Minute
Output Cables (6-Foot)	6-Gauge	8-Gauge	8-Gauge
Battery Types	Standard, AGM, Gel	Standard, AGM, Gel, Deep-Cycle	Standard, AGM, Gel, Deep-Cycle
	\$362.25	\$420.15	\$313.05



ProSeries Fully Automatic Professional Battery Chargers with Engine Start

- These heavy-duty chargers provide generous engine starting power for SUVs, trucks and large engines
- All models include retractable handles, extra-long cables, digital display, LED indicators, touch pad controls and Start/Stop button
- Models DSR122 and DSR124 add **Flash Reprogramming and Memory Saver Mode**
- Charges Standard, AGM, Gel Cell, Deep-Cycle and Start/Stop batteries



	SHM-DSR131	SHM-DSR121	SHM-DSR123	SHM-DSR122	SHM-DSR124
Engine Start – 6 Volt	125A			125A	300A
Engine Start – 12 Volt	250A	250A	250A	275A	330A
Engine Start – 24 Volt			150A		250A
Boost / Service Mode	50A	25A<->50A	10A<->30A / 10A<->50A	20A<->60A	30A<->80A
Charge Rate		15A Fast Charge	15A Fast Charge	15A Fast Charge	15A Fast Charge
Memory Saver Mode				12V DC Port Connection	12V DC Port Connection
Flash Reprogramming Mode				65A Clean Power for Reflashing	70A / 100A Clean Power for Reflashing
Maintainer	2A<->6A	4A Maintain	4A Maintain	4A Maintain	4A Maintain
Warranty	1 Year	1 Year	1 Year	1 Year	1 Year
	\$345.35	\$676.15	\$724.45	\$700.35	\$971.25



SHM-SC1352 **\$708⁵⁵** 12/24V Fully Automatic Battery Charger/Engine Starter for Rugged Use

- For SUVs, trucks and other large engines
- Compatible with standard, AGM, Gel, and Deep-Cycle batteries
- Multi-stage charging
- Battery and alternator tester
- Engine Start: 250A (12V) and 125A (24V)
- Boost mode: 40A (12V) and 20A (24V)
- Charge & maintain: 2A to 6A (12V)



SOLAR CHARGE IT!



Wheeled Automatic Battery Chargers

- Charges all lead acid batteries, AGM, Deep Cycle, Flooded, Spiral Wound, Gel Cell, Marine
- 1 year limited warranty

	SOL-4735	SOL-4745
Voltage Settings	12V	12V/24V
Charging Amps @ 12 Volt	40/10/2A	40/10/2A
Charging Amps @ 24 Volt	—	20/2A
Starting Amps @ 12 Volt	200A	230A
Cable	72" / 4 AWG	72" / 4 AWG
	\$321.25	\$420.45

Battery Chargers

SOLAR PRO-LOGIX

SOL-PL3740 **\$486⁷⁵**
12V 40/15/5A Battery Charger with Stable Power Mode and Engine Start

- 12V Charging rates: 40/15/5A
- 12V Engine start rating: 225A
- 12V Stable power mode: 0-40A on demand
- Reverse polarity protection
- Timed charge routines
- Automatic and manual/timed charge modes
- Multi-phase process
- Ability to charge a totally dead battery
- Properly services all battery types



SOLAR PRO-LOGIX

SOL-PL3760 **\$636⁰⁵**
12/24V 60/40/10/250A Battery Charger with Stable Power Mode and Engine Start

- 12V Charging rates: 60/40/10A
- 12V Engine start rating: 250A
- 12V Stable power mode: 0-60A on demand
- 24V Charging rates: 20/10A
- 24V Stable power mode: 0-20A on demand
- Reverse polarity protection
- Battery fault detection
- Battery recondition mode
- Soft start mode
- Cable: 72", 6 AWG



ASSOCIATED

ASS-3100A **\$272⁷⁵**
6/12 Volt Full Rate Portable Smart Charger with 100A Engine Start

- Automatic 6/12 Volt settings turn off at full charge and turn back on if battery needs more power
- Continuous rating: 12V 15/2 Amps
- 100A Engine Start 12V
- Automatic bad battery detection
- Automatic 6V position for lower voltage requirements
- Designed for Standard, AGM, GEL batteries



SOLAR CHARGE IT!

Smart Chargers

- Automatic operation
- Charges multiple battery types
- Smart clamp technology
- Polarity protection
- Soft start mode for deeply discharged batteries



Item #	Operating Volts	Charging Amps	
SOL-4506	6/12V	6/2 A	\$75.15
SOL-4520	12V	20/10/2 A	\$122.15
SOL-4512	12V	12/6/2 A	\$104.35



PL2310
PL2320
PL2410



PL2545

SOLAR PRO-LOGIX

Fully Automatic Intelligent Battery Chargers/Maintainers

- Properly charges all battery types
- Soft Start Mode for severely depleted batteries
- Reconditions lightly sulfated batteries
- Temperature compensation • Reverse polarity protection • 1 year limited warranty

Item #	Voltage Settings	Charging Amps			Engine Start Method	Cable	
		6 Volt	12 Volt	24 Volt			
SOL-PL2310	6/12V	10/6/2A	10/6/2A	—	—	72" / 12 AWG	\$145.65
SOL-PL2320	6/12V	20/10/2A	20/10/2A	—	—	72" / 12 AWG	\$180.65
SOL-PL2545	12V	—	20/10/2A	—	Timed Starting Process	72" / 12 AWG	\$181.25
SOL-PL2410	12/24V	—	10/6/2A	10/6/2A	—	72" / 12 AWG	\$217.95



PL2112

PL2140

PL4020

1002

Fully Automatic Battery Chargers/Maintainers

- Properly charge a wide variety of battery types, including: Conventional, Maintenance Free, AGM, Spiral Wound, Deep Cycle and Marine
- #PL2112 & #PL2140 are also compatible with Lithium LiFePO4 batteries

Item #	Description	Charging Amps		
		6 Volt	12 Volt	
SOL-PL2112	12V Battery Charger/Maintainer	—	1.0A	\$47.75
SOL-1002	12V Underhood Battery Charger/Maintainer	—	1.5A	\$53.45
SOL-PL2140	6/12V Battery Charger/Maintainer	4A	4A	\$81.35
SOL-PL4020	12V 4x2A Output Battery Maintenance Station	—	2A x 4	\$241.45

Battery Chargers



SHM-DSR134 **\$724⁴⁵**

60A 6V/12V Fast Charger

- Battery type: Standard, AGM, Gel Cell and LiFePO4
- (4) Distinct charging modes
- Start/Stop interface
- LCD display shows remaining charge time, amperage or voltage
- Safe-start, reverse polarity and short circuit protection
- Automatically adjusts the amperage rate to charge and maintain
- Overcharge protection



SHM-DSR145 **\$221⁹⁵**

6V/12V 125A ProSeries Battery Charger/Engine Starter

- Battery type: Standard, AGM
- Engine start: 125A
- Boost/Service mode: 15<->40A
- Charge: 6A
- Service & Recovery modes
- Battery and alternator tester
- Auto voltage detection
- Reverse polarity protection
- Start/Stop interface



SHM-DSR118 **\$221⁹⁵**

6V/12V 125A ProSeries Battery Charger/Engine Starter

- Battery type: Standard, AGM
- Engine start: 125A
- Charge & maintain: 2A to 6A
- Fast charge: 15A to 40A
- Service mode maintains a stable 13.6V while working on a vehicle
- Auto voltage detection
- Reverse hook-up protection



SHM-SC1355 **\$82⁵⁵**

1.5A 6V/12V Fully Automatic Battery Maintainer

- Battery types: Standard, AGM, Deep-Cycle
- Automatically adjusts the amperage rate to charge and maintain
- Multi-stage charging
- Automatically maintains optimum battery charge
- Auto voltage detection
- Reverse hook-up protection



ATD-5915 **\$52⁸⁵**

6V/12V Automatic Battery Charger/Maintainer

- Works on 6 and 12 V systems
- 1.5 Amp 12 Volt charge rate
- Battery types: WET, MF, AGM and GEL
- Reverse polarity indicator
- Overcharge and short circuit protection



12V Solar Panel Chargers

- Charges 12V lead-acid batteries
- Works in cloudy conditions
- Water-resistant
- Ideal for boats, cars, motorcycles, snowmobiles, trucks, RVs and more



SP-200



Item #	Description	Output Current	
SHM-SP-200	Solar Battery Maintainer	2.4 Watt	\$75.05
SHM-SP-400	Solar Battery Charger/Maintainer	4.8 Watt	\$145.05

SHM-SPC-7A **\$52⁵⁵**

Solar Charge Controller

- Protects your battery from overcharge and discharge
- It handles up to 7 Amps of solar array current and up to 100 Watts of solar power



SHM-DSR117 **\$87⁵⁵**

12V 10A ProSeries Fully Automatic Rapid Charger

- Battery type: Standard, AGM, Gel
- Automatically adjusts the amperage rate to charge and maintain
- Multi-stage charging
- 10A rapid charge
- Service mode - maintains voltage at 13.6V to prevent discharge
- Reverse hook-up protection



DSR125



DSR127



6V/12V Automatic Battery Charging Stations

- Charge up to eight 6V and 12V batteries simultaneously
- Battery type: Standard, AGM, Gel, Deep-Cycle, Lithium Ion
- Input voltage: 120V AC • Input current: 12A
- Detachable 6 foot cables with 75 Amp, colour-coded clamps
- Recovery mode - for sulfated Standard and AGM batteries
- Safe-start, reverse polarity and short circuit protection
- Overcharge and thermal runaway protection

Item #	Description	Output Current	
SHM-DSR127	8-Bank	12V, 7A cont.; 4/12A int.	\$1333.05
SHM-DSR125	4-Bank	10A continuous	\$591.65



AUT-BPC-100

Fully Automatic Heavy Duty 12V Smart Charger

- Charges individual 12V batteries and 12V battery packs (up to 8 batteries)
- Compatible with standard/flooded or AGM batteries
- Continuous duty high current charge: 70 Amps @ 115 VAC and 100 Amps @ 230 VAC
- 2 Modes: Fast Charge mode to 80% state of charge and Full Charge mode to 100% capacity state of charge
- Displays remaining charge time
- Audible alert when battery charge completed
- Group 31 battery connection options
- Compatible with the #ES-8 Mobile Cart



BATTERY SERVICE

Battery Chargers

SOLAR PRO-LOGIX

12V 100A Flashing Power Supply and Automatic Battery Charger

- Properly charges AGM, Deep Cycle, Flooded, Spiral Wound & Marine batteries
- Precise voltage control and quick response to load
- Extra long 13 ft. cables • Manages depleted and sulfated batteries



SOL-PL6100
60/40/10A
\$784⁸⁵

SOL-PL6800
100/40/10A
\$827⁹⁵

ASSOCIATED

ASS-ESS6100 **\$2271⁹⁵** 90A Re-Flash Power Supply/ 12V Battery Charger

- **Adjustable voltage re-flash power:** up to 90A on standard 115V 15A outlet, 100A+ on 220V outlet
- **OEM approved** for very specific re-flash voltage from 12.9 to 14.9V
- **Adjustable voltage charger:** meets new charging specs required by several battery and vehicle manufacturers
- **Safe for all battery types** including AGM, EFB, Li-Ion, Gel-Cells and Conventional batteries
- 8.4 ft. 4 AWG DC leads with 400 Amp coated angle clamps (Optional 16.5 ft. DC leads for re-flashing or charging with vehicle on a hoist)
- **Showroom mode** to power vehicle dash boards or other electronics



AUTEL MAXICHARGER

AC Wallbox Level 2 Electric Vehicle Chargers



AC WALLBOX HOME



AC WALLBOX COMMERCIAL

For more info,
please refer to
**Electric & Hybrid
Vehicle Safety
Solutions**
category.

Battery & Electrical System Testers

SOLAR



Battery & System Testers

- Test multiple battery types
- Models #BA227, #BA327 & #BA427 also test Start-Stop batteries

Item #	Battery Voltages	System Testing	Testing Capacity	Printer	
SOL-BA9	12V	12V	40-1200 CCA	No	\$86.05
SOL-BA227	12V	12V	10-1400 CCA	Yes	\$361.05
SOL-BA327	6/12V	12-24V	40-2000 CCA	Yes	\$560.65
SOL-BA427	6/12V	12-24V	40-3000 CCA	Yes	\$616.65

ASSOCIATED

ASS-12-1015 **\$640⁶⁵** Digital Battery & Electrical System Tester with Thermal Printer & USB Port

- Battery range: 100 to 1,700 CCA
- Voltmeter: 9-15 Volts DC
- Battery test displays:**
 - Good/Replace/Recharge-Retest
 - Measured battery CCA rating after test

- Alternator test displays:**
 - Good/Low/High
 - Average/Max/Min during test for loaded and no load test
 - Vehicle ground test

- Tests flooded, AGM Flat Plate, AGM Spiral, Gel Cell, Enhanced Flooded (Start/Stop Batteries)
- Stores last 250 test series • 10 line LCD display



LAUNCH



Battery Tester

- 6 kinds of tests: Ripple Detection, Battery Test, Electric Current Test, Starter Test, Charging System Test, Voltage Test
- Battery tests are quick and accurate (within 3 seconds)

Item #	Description	
LAU-307050055	BST-560 Battery Tester	\$155.35
LAU-307050060	BST-860 Battery Tester with Printer	\$306.25

Battery & Electrical System Testers

AUTEL® MaxiBAS



AUL-BTAK **\$325¹⁵**

Digital Multimeter/ 400A Current Clamp

- Compatible with Autel's MaxiBAS #BT608 and #BT609
- Measures battery strength
- Measures voltage, current and resistance
- AC/DC frequency range up to 20 KHz
- Effective measurement range of 20mA to 400A DC



MaxiBAS Intelligent Battery & Electrical System Diagnostics

- Models BT609, BT608 and BT508 include a wireless Bluetooth VCI (vehicle communication interface) enabling **battery One-Touch registration** after replacement



	AUL-BT609	AUL-BT608	AUL-BT508	AUL-BT506
	Advanced Diagnostics & Maintenance Services	All Systems Diagnostics & Maintenance Services	Battery and Electrical Diagnostics & Service	Battery and Electrical Diagnostics & Service
HARDWARE				
Screen	7" Touchscreen 1280 x 800	5.5" Touchscreen 720 x 1280	Connects to smart devices including MaxiSYS tablets. FREE smartphone App download.	Connects to smart devices including MaxiSYS tablets. FREE smartphone App download.
Onboard Memory / RAM	64GB / 2GB	32GB / 2GB		
Battery	6000mAh, 6H	3000, 6H		
Camera	8mp	8mp		
FEATURES				
CCA Range	100 - 3000 CCA	100 - 3000 CCA	100 - 2000 CCA	100 - 2000 CCA
Battery Type Tested	Flooded, AGM, AGM Spiral, EFB, GEL	Flooded, AGM, AGM Spiral, EFB, GEL	Flooded, AGM, AGM Spiral, EFB, GEL	Flooded, AGM, AGM Spiral, EFB, GEL
Battery Ratings	CCA, CA, MCA, JIS, DIN, SAE, IEC, EN, EN2, BCI, GB	CCA, CA, MCA, JIS, DIN, SAE, IEC, EN, EN2, BCI, GB	CCA, CA, MCA, JIS, DIN, SAE, IEC, EN, EN2, BCI, GB	CCA, CA, MCA, JIS, DIN, SAE, IEC, EN, EN2, BCI, GB
Battery Voltage	6V, 12V	6V, 12V	6V, 12V	6V, 12V
Electrical System Test	12V, 24V Cranking/Charging Systems	12V, 24V Cranking/Charging Systems	12V, 24V Cranking/Charging Systems	12V, 24V Cranking/Charging Systems
Voltage Range	1.5-36V	1.5-36V	1.5-36V	1.5-36V
Temperature Compensation	■	■		
One Touch Battery Registration After Replacement	53 Vehicle Makes	53 Vehicle Makes	53 Vehicle Makes	
Electrical System Reset	■	■	■	
Read & Erase Codes	■	■	■	
Live Data	■			
System Detection	AutoVIN, VINScan, License Plate Scan	AutoVIN, VINScan, License Plate Scan	AutoVIN	
Battery Location Diagrams	■	■	■	■
Battery Health Report	■	■	■	
Built-In Printer		■		
Email Report	■	■	■	■
Cloud-Base Service	■	■	■	■
Multimeter & Amp Clamp	Optional (#BTAK)	Optional (#BTAK)		
DIAGNOSTICS				
All Systems Diagnostics with AutoSCAN	■	■	■ (One vehicle brand ONLY)	
All Maintenance Service Resets	■			
Diagnostic Software Update	1 year FREE Wi-Fi software updates	FREE Wi-Fi software updates for the life of the tool	Charge for additional vehicle brands and annual update	
	\$1004.65	\$728.85	\$402.55	\$274.15

Battery & Electrical System Testers

ATD-5494 **\$315⁹⁵**

Battery Charging & Starting System Diagnostic Tester

- Tests all 12V lead-acid batteries, including AGM and Gel
- 100 - 1700 CCA
- 5V to 33V operating range
- 12V starter test with cranking voltage
- 12V charging test with load and ripple test
- 24V starting & charging test in voltmeter mode
- Displays battery capacity percent and color-coded bar graph
- Detects and alerts bad cells and surface charge



ESI-726 **\$485⁰⁵**

Digital Battery & Electrical System Analyzer with Printer

- Tests 6 & 12 Volt batteries and 12V Start/Stop battery test
- Tests 12 & 24 Volt charging systems
- Tests Alternator-Starting-Charging systems
- CCA test range: 40 to 2,000 CCA
- Tests starting batteries: regular flooded lead acid, AGM flat plate, AGM spiral, VRLA/GEL
- Tests Start/Stop batteries: EFB (enhanced flooded), AGM flat plate
- Rating systems: SAE, EN, DIN, IEC, JIS



ESI-425 **\$118⁴⁵**

Digital Battery & Electrical System Tester

- Batteries tested: 12 Volt
- CCA test range: 200-1,200 CCA
- State of health: actual battery CCA displayed
- Rating systems: SAE, DIN, IEC, EN and CA
- Tests discharged: down to 7V
- Battery types tested: Lead Acid, AGM Spiral, AGM Flat, Gel



BVA-360

6V/12V Battery & Electrical System Tester

- Load test cap: 40A
- Battery types: flooded lead acid, AGM, EFB
- Full system test: battery, starter, and alternator in approx. 60 seconds
- Digital pulse technology for true-load results
- Ease of use with on-board load, no need to repeatedly enter the vehicle to turn on accessories during testing
- Battery ratings: CCA, MCA, CA, En
- LCD touch screen
- Next step advice, hookup diagrams and illustrations
- Built in IR battery temperature measurement
- Wi-Fi communication for seamless integration to optional AMPNET cloud based data management tool
- Performs battery reset (with optional R3-D OBDII Dongle) on most BMW, MINI Coopers, and Ford vehicles



BVA-360KP

Item #	Description
AUT-BVA-360	Battery & Electrical System Tester
AUT-BVA-360KP	Battery & Electrical Syst. Tester with Printer & Charging Station



	AUT-RC-300	AUT-SB-300	AUT-BVA-300
	Battery Tester	Battery Tester	Battery & System Tester
Battery Types	Flooded & SLA	Flooded & AGM	Flooded & AGM
Tension	6 & 12 Volt	6 & 12 Volt	6 & 12 Volt
Battery Range	4AH - 50AH	100-1,600 CCA	100-1,600 CCA
Automated Load	40 Amp	40 Amp	40 Amp
Alternator Test	No	No	Yes
Stator Diode Test	No	No	Yes
Memory	100 Tests	100 Tests	100 Tests
	\$706.45	\$563.95	\$699.65

AUT-BVA-36K



Heavy-Duty Battery & Electrical System Analyzer for 6V & 12V Batteries & Most Charging Systems

- Works well in either an automotive or heavy-duty environment
- 800 Amp variable carbon pile load
- Battery CCA range: 0-1,600
- Alternator test: 12 & 24 Volt
- Stator diode test
- Starter draw test
- Voltage drop test
- Digital auto ranging voltmeter
- Amp probe
- 15 second timer • Fan cooled
- Includes ES-8 deluxe equipment stand



ASS-6042 **\$3068³⁵**

12V 0-500 Amp Variable Carbon Pile Battery Load Tester and 12/24V Electrical Systems Tester

- Tests all battery types up to 1,000 CCA
- Shows positive and negative amps for easy diagnosis of current leakage problems
- Includes model #6043 1,000 Amp AC/DC inductive amp clamp and convenient heavy-duty cart



Battery & Electrical System Testers

MIDTRONICS

MID-PBT-100 **\$313²⁵**

Advanced 12V Battery Conductance Tester

- Measurement range from 200-850 CCA
- Accurate battery test decision in seconds
- Voltmeter mode for testing both the starter and the charging system



MID-PBT-300 **\$550⁵⁵**

Diagnostic 12V Battery Conductance/Electrical System Tester

- Measurement range from 100-1,400 CCA
- Shows available power in CCAs at the end of each test
- Accurate battery test decision in seconds
- Bad cell detection
- Voltmeter mode for testing both the starter and the charging system
- High/low voltage capture for improved starter and charging system testing



MID-MDX-700 HD **\$1481⁷⁵**

Heavy Duty Battery Conductance and Electrical System Analyzer

- For testing 6 and 12 volt batteries in 12 to 24 volt systems consisting of one or as many as six batteries (in a pack)
- 15 ft. cable and heavy duty battery clamps
- Accurate test results up to 2,000 CCA
- Battery types: Regular Flooded, AGM, Gel
- Vehicle applications: Group 31, Automotive, Motorcycle, Marine Cranking, Lawn and Garden, Commercial 4D/8D



MID-MDX-P300 **\$1042¹⁵**

12V Battery Conductance and Electrical System Tester for Cars & Light Trucks

- Built-in printer
- Measurement range: 100 to 1,400 CCA
- Tests starting and charging system voltage
- Voltmeter: 0.9-16 VDC, +/- 0.05 VDC
- Bad cell detection
- Rating systems: CCA, CA, MCA, SAE, DIN, EN, IEC, JIS
- Tests multiple battery types including standard flooded, AGM, and GEL



ASSOCIATED

ASS-12-2415 **\$730⁸⁵**

Multi-Function Graphical Tester

- Tests 12V battery & electrical systems
- Tests 24V starter & alternator systems
- Fully graphical display
- Integrated thermal printer
- Internal memory storage of up to 70 tests
- Tests a wide range of batteries including WET, AGM, EFB (Stop-Start) and Gel
- Multiple rating system: CCA/SAE, CA/MCA, DIN, EN1, EN2, IEC, JIS#)
- Connects to laptop/computer via USB cable



MIDTRONICS

MID-MDX-650P SOH

Battery Conductance & Electrical System Analyzer

- Integrated thermal printer
- Applications: - 6 & 12 Volt batteries - 12 & 24 Volt charging systems
- Measurement range: 100 to 2,000 CCA
- For regular flooded batteries and battery formats designed for start-stop vehicles: EFB, AGM
- Test results include a battery State of Health graph
- Voltage range: 1VDC - 30VDC
- Rubber boot protects tester from shock and abuse



BOSCH

BSD-1699200244 **\$623⁷⁵**

BAT 135 Battery Tester with Printer

- Tests 6V, 12V batteries and 12V, 24V charging systems
- Measurement range: 40-2,000 CCA
- Test all automotive, light-duty and commercial batteries including: AGM, Gel Cell, Flooded lead-acid, Start/Stop EFB, Commercial, SLI
- Presents State of Health and State of Charge percentage
- Full charging system test with diode/ripple test



MIDTRONICS

MID-DSS-5000 HD

12/24V Heavy-Duty Commercial Truck and Fleet Battery & Electrical System Analyzer

- Applications: Group 31, Commercial 4D / 8D, Automotive
- Supports: conventional lead acid, EFB, AGM, and Pure Lead batteries
- Battery ratings: CCA, CA, MCA, JIS, DIN, SAE, IEC, EN
- Supports RP129 electrical system diagnostics
- Conductance Profiling™ technology identifies reserve capacity issues
- On-tool Wi-Fi and Bluetooth capabilities
- Print or e-mail test results via Wi-Fi • Stores all historical records
- Includes: controller with 5" colour touchscreen, tester pod, charging/storage dock, 3m (9.8 ft.) battery test cables, DMM cables for cable voltage drop testing



Auto Meter

AUT-BCT-200J

Intelli-Check II Professional Heavy-Duty Truck Electrical System Analyzer

- Battery voltage/types: 6 & 12 Volt, Flooded & AGM
- Battery CCA range: 200-1,600
- Alternator test: 12 & 24 Volt
- Automated load: 120 Amp
- Stator diode test
- Starter draw test: V-drop
- Voltage drop test: automated



Battery Testers



SOL-1852 **\$39⁴⁵**

100 Amp 6 & 12 Volt Battery Load Tester

- Specially designed for professional use to test batteries, charging systems and starting systems
- Tests batteries to 1000 CCA
- Color-coded full-size meter
- 1 Year limited warranty



ASS-6026 **\$123⁹⁵**

135 Amp Hand-Held Battery Load Tester

- Test 6 & 12 Volt batteries, alternators and starters
- Voltmeter: 0-16 Volts DC



ESI-700 **\$77⁷⁵**

100 Amp Analog Battery Load Tester

- Tests battery voltage, relative starter current draw, charging voltage and battery condition



ASS-6033 **\$281¹⁵**

Digital 125 Amp Battery Load Tester

- Automatically computes the CCA of the battery under load
- Voltmeter: 7-9 Volts DC
- Tests all battery types including Flooded, Maintenance Free, Deep Cycle, AGM and Gel
- Displays:
 - Current battery voltage
 - Maximum Voltage reading
 - Minimum Voltage reading



ESI-706 **\$110⁷⁵**

100 Amp Digital Battery Load Tester with Automatic Test

- Tests battery voltage, relative starter current draw, charging voltage and battery condition



AUT-SB-5/2 **\$1271⁶⁵**

Heavy-Duty 6 & 12 Volt Battery Tester

- Carbon pile load 12 Volt: 800 Amp
- Carbon pile load 6 Volt: 400 Amp
- Battery CCA range: 0-1,600
- Alternator test: 12V
- Simulated starter draw test
- 15 second timer • Fan cooled
- Volt scale: 0-16



ATD-5488 **\$51⁰⁵**

100 Amp 6 & 12 Volt Battery Load Tester

- For conventional and maintenance free batteries



ASS-6029 **\$208⁶⁵**

125 Amp Durable Hand-Held Battery Tester

- Test 6 & 12 Volt batteries, alternators and starters
- 125 Amp fixed load
- Voltmeter: 0-16 Volts DC



ESI-710 **\$221⁶⁵**

500 Amp Variable Load Carbon Pile Load Tester

- Tests 12V batteries rated as high as 1,000 CCA or 160 Amp hour
- Can also test alternators, regulators and starters



Battery Testers

SOLAR.

Variable Load Carbon Pile Battery Testers

- Can also be used to assess starter and alternator performance
- 1 year limited warranty



Item #	Operating Voltages	Variable Load Capability	Testing Capacity	Cable Reach	
SOL-1874	12V	500A	1000 CCA	43"	\$186.95
SOL-1876	6/12/24V	1000A	2000 CCA	56"	\$444.55

ATD-5489 **\$218⁶⁵** 500 Amp Variable Load Carbon Pile Battery Tester

- Test 12V batteries, alternators and starters
- Tests batteries up to 1000 CCA



Inverters

SOLAR.

Power Inverters

- Provides stable, clean and reliable power resulting in smooth, consistent operation for powered devices



Item #	Continuous Power	Peak Power	AC Outlets	USB Outlets	
SOL-PI1000X	1000W	2000W	2	0	\$256.95
SOL-PI1500X	1500W	3000W	3	0	\$430.55
SOL-PI2000X	2000W	4000W	3	0	\$459.75
SOL-PI3000X	3000W	6000W	3	0	\$789.35

ATD

Power Inverters

Item #	Continuous Power	Peak Power	AC Outlets	USB Outlets	
ATD-5954	1500W	3000W	3	2	\$523.25
ATD-5956	3000W	6000W	3	2	\$1095.25



Memory Savers

EZRED

EZR-MS4000 **\$170⁸⁵** Automotive Memory Saver with Built-In Charger

- 12V, 4.5 Ah sealed lead acid battery included inside unit
- OBDII connector
- Saves and protects all drivability codes and settings when disconnecting a vehicle's starter battery



EZR-MS4000C **\$201⁰⁵** Automotive Memory Saver with Built-In Charger

- Includes 12V adapter for older vehicles that do not have OBDII ports

Schumacher

SHM-OBD-L **\$110⁰⁵** On-Board Diagnostics OBDII Memory Saver Detector

- Works on all vehicles equipped with a standard OBDII port
- Automatically detects if the vehicle's electronics will allow this device to save on-board data



AUTEL

AUL-BTMS **\$61⁹⁵** OBDII Memory Saver

- Preserves vehicle codes and electronic presets when replacing the battery
- Enables vehicle computer to be powered and maintain data when connected to backup battery
- Connects to vehicle via OBDII and 12 Volt battery
- Surge protection and LED status lights



EZR-MSBD28 **\$32⁶⁵** Automotive Memory Saver

- Cord stretches to 8 feet
- OBDII connection, will not interfere with fault codes
- Prevents the loss of electronic memory when disconnecting the vehicle's battery



SOL-ESA30 **\$17⁴⁵** OBDII Memory Saver Connector

- Turns any jump starter with a 12V power port into a memory saver
- Prevents electronic memory loss when disconnecting a vehicle's battery
- Compatible with all Booster PAC, Truck PAC and Jump-N-Carry models except ES8000



Battery Maintenance Tools & Accessories



EZR-SP101 **\$14⁸⁵**

Battery Hydrometer

- Range: 1.100 – 1.300 specific gravity



EZR-BK541 **\$21⁴⁵**

Four-in-One Battery Post Cleaner

- Service most battery post types and cable ends with one tool
- Top post, Group 31 Truck, Marine, and Side Terminal



GWR-2173DD **\$14⁷⁵**

Three-Way Battery Tool

- Sharp steel blades remove corrosion and put a correct angle on terminal clamps and posts
- Use the 6-Blade, tapered reamer to quickly clean terminal clamps
- Post cleaners are marked positive and negative, and are sized to accurately fit terminal posts and cut the correct angle



VIM-BS1 **\$9³⁵**

10" Long Pro Style Battery Service Brush

- Stainless steel bristles



EZR-BK520 **\$20⁸⁵**

Side Grip Battery Lifter

- Lifts batteries from 4-1/2" to 7-1/2" wide



EZR-793CS **\$29⁵⁵**

Adjustable Battery Cable Stripper

- Adjustable blade
- Strips insulation jacket from cable, 8 gauge to 4/0 AWG



LIS-55480 **\$88⁸⁵**

Cable Insulation Splitter

- Works on single and multiple conductor cables up to 1.25" O.D.
- Adjustable blade allows for variable insulation thickness up to 0.187"



EZR-B795 **\$255⁸⁵**

Heavy-Duty Crimpers

- 50 different crimp settings
- 6 gauge through approximately 5/8" cable



EZR-B7946 **\$125⁰⁵**

3 Point Wire Crimping Tool

- Does a 3 point crimp all at one time
- Crimps up to 4/0 AWG cables
- Can be used with a 3/8" impact battery drill

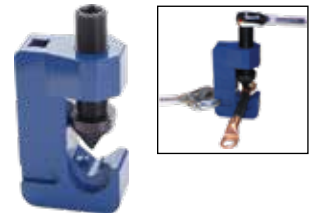

LIS-54150 **\$41⁸⁵**

Battery Terminal & Wiper Arm Puller

- Made in USA



GWR-202D **\$30⁶⁵**

Battery Terminal Puller



LAN-B-10A **\$17¹⁵**

5/16" Reversible Ratcheting Side Terminal Battery Wrench

- Made in USA



Work Lights



ALT-3230SMS **\$159²⁵**
30 SMD LED Work Light on Steel Reel

- 500 lumens
- 30 ft. 13/2 SJT cord
- Max. rating: 5W, 0.07A, 120V
- Dual Hanging hooks rotate 360°
- Includes hanging hardware



BAY-SL-864 **\$220¹⁵**
60 LED Work Light on Heavy Duty Metal Reel

- 120 lumens
- 50 ft. 18/2 SVT cord
- Top and side built-in magnets with a magnetic swivel hook
- Includes mounting brackets



ALT-5050CL8 **\$198⁸⁵**
8 Watt Professional Grade COB LED Work Light on a Retractable Steel Cord Reel

- 1,000 lumens
- 50 ft. 18/2 SJT cord
- Max. rating: 0.13A, 125 VAC
- Folding swivel hook on light
- Integrated magnet
- Includes hardware for wall or ceiling mounting



BAY-SL-866 **\$264¹⁵**
LED Work Light on Heavy Duty Metal Reel

- 1,200/600 lumens
- 50 ft. 18/2 SVT cord
- Top and side built-in magnets with a magnetic swivel hook
- Includes mounting brackets



ALT-5030AM **\$200⁴⁵**
14 Watt COB LED Work Light on Rugged Steel Reel

- 1,500 lumens
- 30 ft. 16/3 SJTOW cord
- Max. rating: 1,440W, 12A, 120V
- Grounded outlet in handle
- Integrated magnet
- Folding swivel hook



BAY-SL-2125 **\$127³⁵**
60 LED Corded Work Light

- 120 lumens
- 25 ft. 18/2 SJT cord
- Two built-in magnets with magnetic hook
- Octagonal anti-roll body design
- Chemical/moisture/impact resistant housing



ALT-8150MM **\$377⁸⁵**
14 Watt COB LED Work Light on Industrial Grade Thermoplastic Reel

- 1,3500 lumens
- 50 ft. 14/3 SJT cord
- Max. rating: 1,625W, 13A, 125V
- Grounded outlet in handle
- Integrated magnet
- Folding swivel hook
- Heavy duty steel mounting bracket



ALT-KWC625 **\$83⁰⁵**
8 Watt COB LED Corded Work Light

- 500 lumens
- 25 ft. 18/2 SJTW cord
- Magnet or hook mountable
- Waterproof: IP65
- Impact rating: IK07



Work Lights



ATD-80076 **\$102⁴⁵** Incandescent Utility Light

- 50 ft. 16/3 SJTOW cord, oil & water resistant and remains flexible in extreme cold weather
- 3-prong grounded outlet for auxiliary power
- Metal guard
- Uses max. 75 W bulbs (not included)



Incandescent Work Light

- Grounded outlet handle
- 13 amp circuit breaker
- 16/3 SJTOW cord

Item #	Cord	
CLP-101307	23 ft.	\$66.25
CLP-101315	50 ft.	\$106.25



Incandescent Work Lights with Metal Guard

- Max. 75W incandescent bulb (not included)
- 12 amp grounded single outlet
- Cord gauge: 16/3 SJT

Item #	Cord	
BAY-SL-425A	25 ft.	\$56.55
BAY-SL-426A	50 ft.	\$94.35



BAY-SL-204 **\$18⁸⁵** Replacement Incandescent Work Light Head with Metal Guard & Single Outlet

- Fits Bayco 450 & 840 incandescent models



Light-N-Carry COB LED Rechargeable Work Lights

- 60 lumens focus beam
- Mounting hook and belt clip
- 180° swivel action magnet mounting
- Water resistant
- Wall charger with braided USB cable



Item #	High Mode	Low Mode	Run Time	
SOL-LNC1841	800 lumens	210 lumens	Up to 3.5 hrs	\$108.95
SOL-LNC1541	500 lumens	150 lumens	Up to 4 hrs	\$81.55
SOL-LNC1341	300 lumens	90 lumens	Up to 4 hrs	\$55.35
SOL-LNC1241	200 lumens	60 lumens	Up to 4 hrs	\$45.95

SOL-LNCMINI **\$36⁰⁵** Pocket COB LED Rechargeable Work Light

- Lumens: 110/35, 4 hrs
- 60 lumens focus beam
- 180° swivel action magnet mounting
- Water resistant housing
- Wall charger with USB cable



SHM-SL137RU **\$162⁵⁵** 360° Plus Rechargeable Lithium Ion LED Work Light with Top Light

- Lumens: 600
- Comes with 2 rechargeable Li-Ion batteries
- 360° swivel and tilt
- Super strong magnets and swivel hooks
- USB-Micro USB charging cable



SHM-SL360RU **\$106⁶⁵** 360° Rechargeable Lithium Ion LED Work Light with Top Light

- Lumens: 400
- 360° swivel and tilt
- Super strong magnets and swivel hooks
- USB-Micro USB charging cable



SHM-SL26GU **\$71⁷⁵** Mini Lithium Ion 360° Rechargeable LED Work Light

- Lumens: 200
- 360° swivel and tilt
- Super strong magnet and swivel hook
- USB-Micro USB charging cable



Work Lights

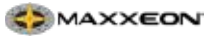

MXN-01020 \$100²⁵
12" LumaStik™ Rechargeable Folding 3 Way Work Light

- Front and back floodlights, and a spotlight on the tip
- Lumens: 800/400/50
- Runtime: 2.5/4/12 hrs
- Powerful integrated magnet
- LED charge indicators
- Includes USB-C charging cable



MXN-01024 \$114⁵⁵
WorkStar® LumaStik® Rechargeable Combo UV & White Beam Magnetic Inspection Light

- UV Light: 395nm, 630mW – 5 minutes (one cycle)
- Floodlight: 800/150 lumens, 2.5 hrs/8 hrs
- Spotlight: 150 lumens, 8 hrs
- Powerful integrated magnets
- LED charge indicators
- Includes type C USB charging cable
- Charge time: 4 hr
- Dimensions: 6.4" X 1.1" X 1.7"



MLW-2128-22 \$217⁹⁵
REDLITHIUM™ USB Stick Light with Magnet & Charging Dock

- 7.5" compact size
- Lumens: 550/250
- Runtime: 2/5 hrs
- 4 light modes: front, back, dual, inspection
- Light blade rotates 220° vertically
- Magnetic base and hook to mount
- Magnetic USB-C sequential charging dock and second battery bay; dock also includes mounting keyholes
- Light can be charged using the USB-C port or the charging dock



STM-76800 \$163¹⁵
Stinger Switchblade® LED Rechargeable Multifunction Worklight

- Folded: 9.8"; Extended: 17"
- Cool white LED: 800 lumens, 3.75 hrs
- Colour match LED: 600 lumens, 3.75 hrs
- UV LED: 500 mW, 15 hrs
- Includes a 5" USB cable



AST-52SL \$89⁵⁵
1,000 Lumens Wirelessly Rechargeable Folding Double-Side LED Slim Light

- Front and back main lights: 2 x 500 lumens, 3.25 to 8 hrs
- Top light: 150 lumens, up to 8 hrs
- Magnetic base and handle; folding hook
- Includes USB-C charging cable and adapter
- Can be wirelessly recharged with your smart phone's charging pad or use the optional Magnetic Dual Charging Pad #AST-52SL-WCP



Ultra-Thin Flex-Head Work Light

- Dual light settings on light bar
- Single 30 lumen light on top
- Magnet and hang hook in base
- Integrated belt hook

Item #	Lumens	Length	
GWR-83134	75-150	8"	\$72.85
GWR-83135	250-500	12-1/2"	\$123.45



Replacement Light Bulbs



BAY-SL-103PDQ \$9²⁵
Replacement 13W Fluorescent Bulb
 • Fits Bayco fluorescent models: 503, 507, 520, 550, 651, 676, 677, 821, 825, 826, 827, 904, 907, 935, 936, 964 & 8907



BAY-SL-104PDQ \$9²⁵
Replacement 13W Fluorescent Bulb
 • Fits Bayco fluorescent models: 908, 975, 976 & 8908



ALT-KWR700T \$117³⁵
Rechargeable COB LED Foldable Slim Work Light

- 70-700 lumens
- Top 120 lumens LED flash light
- Dimmer switch
- Rotates 180°
- IP54 rainproof
- Battery level/charge status indicator
- Strong magnet & hook
- Rubberized handle
- USB-C charging cable included



Work Lights



ATD-80303 **\$136¹⁵**
290 Lumens Li-Ion Rechargeable LED Strip Light

- Length: 11-1/4"
- Runtime: 2-3 hours
- Auto shut-off & over charge protection
- 180° horizontal rotate function
- 360° rotating hook
- Built-in magnet



ATD-80304A **\$153¹⁵**
400 Lumen Rechargeable COB LED Work Light with Top Light

- Lumens: 400/200
- Top bulb: 160 lumens
- Runtime: 2.5 hrs/5 hrs
- Length: 10.5"
- Auto shut-off and overcharge protection
- 360° rotating hanging hook
- Magnetic base
- 3-in-1 charging system



ATD-80395A **\$198²⁵**
800 Lumen Rechargeable COB LED Work Light with Top Light

- Lumens: 800/400
- Top bulb: 160 lumens
- Runtime: 2.5 hrs/5 hrs
- Length: 11.7"
- Auto shut-off and overcharge protection
- Magnetic base
- 3-in-1 charging system



CLP-114301 **\$132²⁵**
HEMImini™ Rechargeable Work Light

- Lumens: 1,000/500
- Runtime: 4 hrs/8 hrs
- Aluminum chassis
- Rechargeable in approximately 3.5-4 hours



Rechargeable Logo COB LED Xtreme Work Lights

- Lumens: 500/150; 3 hrs/6 hrs
- Micro USB charging port
- Dimmable logo COB and spot
- Magnets on bottom and back

Item #	Colour	
EZR-XL5500-BL		\$117.85
EZR-XL5500-OR		\$117.85



ALT-KCR10 **\$92⁶⁵**
Rechargeable COB LED Work Light with Li-Ion Battery

- 800/400 lumens
- Hanging hook swivels 360°
- Integrated magnets on back and base
- AC charger with USB cord



MLW-2352-20 **\$78⁹⁵**
11.5" M18™ Stick Light with 45° Pivoting Head (Bare Tool)

- Lumens: 300/150
- Runtime: 17/36 hrs (with XC5.0 battery, not included)
- Two integrated multi-position stainless steel hooks



AST-72SL **\$129⁵⁵**
Rechargeable LED Slim Light with Top Flashlight

- 60-720 lumens
- 120 lumens LED top flashlight
- 8 hrs at 50% power, 3.5 hrs on high
- Swivel base with 20lb magnet and ratcheting extendable base hook
- Wall adapter and USB-C charge cable



COB LED Li-Ion Rechargeable Tube Light

- Top SMD LED: 80 lumens; 10 hrs
- Removable lithium-ion battery pack can be used as USB power source for charging electronic devices
- Removable swivel hooks with magnets
- Includes USB-C charge cord



Item #	Lumens High/Low	Run Time	Length	
ATD-80360A	500/250	3/6 hrs	14.75"	\$126.05
ATD-80390A	700/350	2.25/4.5 hrs	15.25"	\$133.85



Work Lights



Xtreme Lumens™ Multi-Purpose Rechargeable LED Work Lights

- Length: 14.6" • Lumens: 600/225
- Runtime: 4.5/12.5 hrs
- Charge time: 6 hrs
- Water-resistant
- AC/DC power supplies, charger and magnetic hook

Item #	Colour	
BAY-NSR-2168B	●	\$119.45
BAY-NSR-2168R	●	\$119.45



BAY-SLR-2166 **\$106⁹⁵**

Rechargeable 60 LED Multi-Purpose Work Light

- Length: 14.3"
- Floodlight lumens: 230, 3 hrs
- Spotlight lumens: 32, 18 hrs
- Recharge time: 8 hrs
- Water & impact resistant



SHM-SL184RU **\$115⁰⁵**

Lithium Ion 360° Slim Rechargeable Work Light

- 16 super-bright SMD LEDs
- Lumens: 600
- Rotary dimmer switch
- 360° swivel and tilt
- Strong magnetic base
- USB-Micro USB charging cable



AST-100SL **\$95⁵⁵**

USB & Wirelessly Rechargeable Mini LED Flood Light

- Dimmable light output
- Lumens: 100-1,000
- Runtime: 3-18 hrs
- Foldable magnetic base
- Charge level indicator
- Water and impact resistance
- Includes USB-C charging cable
- Wireless charging with optional #AST-52SL-WCP magnetic dual charging pad



Optional #52SL-WCP Magnetic Dual Charging Pad

M18™ Utility Remote Controlled Search Light

- Flood: 4,250 lumens, 3.5 hrs
- Flood low: 1,500 lumens; 12 hrs
- Spot: 3,500 lumens, 3.5 hrs, 1,143m beam distance
- 370° horizontal & 70° vertical remote controlled tilt
- Impact and weather resistant
- All kits include: Joystick remote control, 12V DC permanent base for vehicle mounting, remote control dash mount



Item #	M18™ Portable Magnetic Base	M18™ HD12.0 Battery	M18™/M12™ Charger	Carry Bag	
MLW-2123					\$748.95
MLW-2123-20	✓			✓	\$1248.95
MLW-2123-21HD	✓	✓	✓	✓	\$1498.95

MLW-2366-20 **\$165⁰⁵**

M18™ ROVER™ Dual Power Flood Lights

- Lumens: 4,000/2,000/1,200
- Runtime: 3/6/12 hrs
- 120° light head rotation
- Two sources of power: M18™ cordless or 120V corded
- Run times rated on an 18V M18™ XC5.0 battery, (sold separately)



MLW-2367-20 **\$87⁹⁵**

M12™ ROVER™ Rechargeable Magnetic LED Flood Light with USB Port

- Lumens: 700/250
- Strong rear-facing magnet
- Integrated keyhole for hanging
- 2.1Amp USB port for charging your devices
- Run time: 8 hr/ 24 hr (with an M12™ XC4.0 battery, not included)



MLW-2114-21 **\$99⁹⁵**

5.4" USB ROVER™ 210° Pivoting Flood Light

- Lumens: 550/250/100
- Runtime: 2/4.5/11.5 hrs
- Wide, magnetic base
- Built-in carabiner



SOL-LNC2251 **\$114⁷⁵**

COB LED Rechargeable Flood Light

- High/Med/Low: 1,500/1,000/500 lumens
- 180° swivel arm with magnetic mounts
- 1A USB power supply to charge small electronic devices
- IP64 dust / water protection
- LED battery status display
- Includes 2 batteries
- Wall charger



Work Lights



Xtreme Rechargeable Focusing Work Lights

- Lumens: 1000/500
- Runtime: 4/8 hours
- Detachable magnetic base
- Stepless dimmer
- USB charge cord
- USB charging of compatible devices

Item #	Colour	
EZR-XLF1000	●	\$103.05
EZR-XLF1000-GR	●	\$103.05
EZR-XLF1000-OR	●	\$103.05



Rechargeable Logo Work Lights with Magnetic Base

- Stepless dimming feature
- 500/250 lumens; 3/6 hours



Item #	Colour	
EZR-XLM500-RD	●	\$75.75
EZR-XLM500-OR	●	\$75.75



MXN-00900 **\$135⁶⁵**

MaxxBeam™ – Focusable Magnetic Area Light with Wireless Charging

- Lumens: 1,200/650/320
- Runtime: 2.5/5.5/14 hrs
- 5X focusable beam lens from spot to flood
- Rotating handle with threaded accessory port
- Wireless induction charging pad
- Includes USB-C charge cable



Cyclops™ – Rechargeable Magnetic Area Light

- Lumens: 720/360/180
- Runtime: 2/4.5/10 hrs
- Includes USB C charge port and cord



Item #	Colour	
MXN-00810	●	\$62.35
MXN-00811	●	\$62.35
MXN-00812	●	\$62.35
MXN-00813	●	\$62.35
MXN-00814	●	\$62.35



STM-61530 **\$67⁵⁵**

Syclone® Jr. Ultra-Compact USB Rechargeable LED Worklight

- 2" L x 2.25" W x 1.14" D
- Lumens: 210/85 • Runtime: 3.75/8.5 hrs
- 360° rotating body • Magnetic base
- IPX4 water resistant • 2m impact resistant
- USB charge cord



STM-61520 **\$276¹⁵**

BearTrap® Multi-Function Work Light

- 7.62" H x 6.5" W
- Flood: 2000/1000/575 lumens; 2.5/5/7.5 hrs
- Spot: 1000/450/325 lumens; 4.5/8.75/12.5 hrs
- Hands-free: Clamps virtually anywhere, magnetic base, hang hook, stands on its own
- Includes 120V AC charger



Flipmate™ Compact Rechargeable Multi-Function Work Lights

- USB rechargeable
- 270° rotating light head
- Magnetic base

- Operating modes:
- Cool white LEDs for bright light: 500/250 lumens; 2.5/5.75 hrs
 - 90 CRI LEDs (Color-Rite Technology): 400/200 lumens; 2.5/6 hrs



Item #	Colour	
STM-61500	●	\$143.85
STM-61501	●	\$143.85
STM-61502	●	\$143.85



\$245⁸⁵

BAY-NSR-1514 Rechargeable LED Area Light with Magnetic Base

- Lumens: 1,000/500
- Runtime: 4 hrs/8 hrs
- AC & DC charging cords
- 12" L x 6.1" W x 3.5" D



\$165⁰⁵

BAY-SL-1514 LED Single Fixture Work Light with Magnetic Base

- Lumens: 2,200
- 12 ft. SVT 18/3 cord
- 11.5" L x 6.2" W x 3.1" D



ALT-LZR10C **\$65⁰⁵**

USB Rechargeable COB LED Flood Light

- 1,200/600 lumens
- Charge status indicator lights
- Magnetic base tilts and rotates
- USB power bank charges your devices
- IP54 Water resistant



Work Lights



M12™ Rechargeable Magnetic Underbody Work Light

- Lumens: 1,200/800/600
- Runtime 5/8/15 hrs
- Dual joints swivel 300° horizontally and up to 180° vertically
- Strong magnetic base
- 12" magnetic storage tray to hold nuts & bolts
- Impact, dust, water & chemical resistant



Item #	Description	
MLW-2126-21XC	M12™ Underbody Light Kit Includes (1) M12V XC4.0 Battery & (1) Charger	\$367.95
MLW-2126-20	M12™ Underbody Light (Bare Tool)	\$267.95



Schumacher

SHM-SL197U **\$117⁵⁵**

15 SMD LED Rechargeable Magnetic Work Light

- Light up tool boxes, cabinets, work stations, etc.
- Lumens: 150/100
- Sliding magnetic brackets rotate 180°
- Micro USB charging cable



PWP-PPMWL1000 **\$312²⁵**

COB LED Modular Magnetic Work Light

- Lumens: 1000/500 (250/125 lumens per module)
- Runtime: 3/6 hours
- Can be used as an under-hood light, an area spot light or four individual work lights
- Magnet, hook, power button and 1/4" threaded hole for tripod mounting on each module
- AC charger



PWP-PPTK0047 **\$62⁷⁵**
Replacement Light Module for #PPMWL1000 Modular Work Light
 • 250/125 lumens

POWER PROBE

Portable SMD LED Flood Light

- Adjustable tilt head and handle
- 6 ft 18/3 SJTW cord
- "ON/OFF" switch
- Tripod ready
- IP54 rainproof rated

ALERT
PROLITE



Item #	LEDs	Lumens	Maximum Rating	
ALT-LF84S	84	5,000	52W, 0.45A, 120V	\$90.95

ALT-LF140S **\$150⁴⁵** 10,000 Lumen LED Flood Light

- Indoor/outdoor use, IP54 rainproof
- Adjustable light angle
- Push button ON/OFF switch
- 6 ft 18/3 SJTW cord • 95W, 0.8A, 120V



1,400 Lumens 16W LED Work Lights for Loading Docks and Inside Trailers

- Diecast aluminum housing
- 180° swivel mounting bracket on light head (ATD-80416)
- Swivel bracket on dock light arm for easy wall mounting (ATD-80417)
- Cord: 16 ft., 18/3 SJTOW, remains flexible in cold weather
- IP67 dust and water resistance
- CSA approved for outdoor use



Item #	Description	
ATD-80416	Loading Dock Light	\$306.35
ATD-80417	Loading Dock Light with 40" Swing Arm	\$400.85

Portable SMD LED Flood Lights

- Adjustable tilt and rotating heads
- 56" tripod
- 6 ft. 18/3 SJTW cord
- Separate "ON/OFF" switches
- IP54 rainproof rated

ALERT



Item #	LED	Lumens	Max. Rating	
ALT-LF168ST	Twin 84	10,000	103W, 0.86A, 120V	\$230.45
ALT-LF240ST	Twin 120	14,000	130W, 1.1A, 120V	\$282.45

BAYCO

BAY-SL-1522 **\$342⁷⁵** LED Convertible Dual Fixture Work Light on Tripod Stand

- Floodlight lumens: 2,200/4,400
- 6 ft. power cord
- 82.5" L x 18.4" W x 7.3" D



Work Lights



SABER

ATD-80335 **\$404⁵⁵**
4,200 Lumen 35W Heavy Duty COB LED Flood Light with Telescopic Stand

- 16 ft. 18/3 SJTW cord
- 160° horizontal rotation on base
- Rotating telescopic stand extends from 34" to 7", and folds for storage
- IP67 rated for dust and water resistance • CSA approved

MLW-2131-20 **\$302⁵⁵**

M18™ ROCKET™ Dual Power Tower Light

- 2,500/1,100/700 lumens
- Adjustable pivoting and rotating head
- Extends from 4 to 7 feet
- Dual power: M18™ or AC extension cord



Milwaukee

Lanterns / Utility Lights

STM-44371 **\$387⁴⁵**

Vulcan® Clutch Multi-Function Rechargeable Lantern

- Lumens: 1,700 / 380
- Runtime: 6.5 hrs / 18 hrs
- Beam distance: 520m/245m
- Flash mode (25 hrs)
- 340° rotating head • Versatile clamping handle
- 1m water and 2m impact resistant
- Includes strap, charging rack and AC/DC chargers



STREAMLIGHT



MAXXEON

MXN-04100 **\$235⁵⁵**

SearchPoint® HORIZON Rechargeable Magnetic Spotlight/Floodlight

- 4x Zoomable lens: spot beam to flood beam
- Lumens: 3,000 / 1,200 / 600 • Runtime: 2.5 hrs / 5.5 hrs / 12.5 hrs
- Strong magnetic base with 150 lb pull force • 90° Rotating hook
- IK 07 shock and resistant and IP 65 water resistant
- Includes: carrying case, lanyard, USB-C cable
- Dimensions: 7.4" x 5.9" x 2.6"



STM-44301 **\$387⁴⁵**

Vulcan® 180 C4 LED Multi-Function, Li-Ion Rechargeable Lantern

- Lumens: 1,200 / 350
- Runtime: 5.75 hrs / 16 hrs
- Beam distance: 548m/296m
- 180° articulating head
- 1m water and 2m impact resistant
- Charging rack and AC/DC chargers



EZR-CT6525 **\$43⁷⁵**

4.5" Rechargeable Micro Utility Light

- Lumens: 200/100; 6/14 hrs • Magnetic base
- Water & impact resistant • Recessed hooks
- USB charge port and cord



EZR-CT6515 **\$71⁴⁵**

4.5" Dual Function Rechargeable Utility Light

- 225 lumens lantern • 115 lumens top light
- Runtime: up to 12 hrs • Magnetic base
- Recessed hooks • Water & impact resistant
- Includes USB charge cord

CAT



STM-44910 **\$246⁴⁵**

Waypoint® 400 Rechargeable Long-Range Pistol Grip Spotlight

- Lumens: 1,400 / 680 / 38
- Runtime: 3.25 hrs / 7.5 / 84 hrs
- Beam distance: 1,265m / 735m / 200m
- Waterproof to 2m and 1m impact resistant
- Integrated stand
- Includes polymer holder/mount and 120V AC charger



STREAMLIGHT

The Siege® Coyote C4 LED Lanterns

- White light, red light and flash SOS modes
- Waterproof to 1m, it floats, impact resistance to 2m
- #44931 requires (3) "D" batteries
- #44941 requires (3) "AA" batteries



STM-44900 **\$123²⁵**

Waypoint® C4 LED Pistol Grip Spotlight

- Lumens: 550 / 40; 10 hrs / 82 hrs
- Water resistant, 1m impact resistance
- Integrated stand
- Operates using (4) "C" alkaline batteries (not included) or 12V DC power cord



Item #	Lumens	Run Time	Size	
STM-44931	540 / 275 / 55	30 / 70 / 295 hrs	3.8" x 7.25"	\$81.45
STM-44941	200 / 100 / 50	7 / 15.5 / 37 hrs	2.37" x 5.44"	\$60.15

MLW-2354-20 **\$148⁹⁵**

M18™ Search Light

- 1,250 lumens
- Four modes: Spot, Flood, Spot/Flood, Strobe
- 198° light head rotation
- Beam distance: 667m
- Water and dust resistant

Milwaukee



STM-44956 **\$89⁵⁵**

Siege® X USB-Rechargeable Ultra-Compact Lantern

- White light, red light, flash SOS modes
- 325 / 175 / 30 lumens
- Runtime: 4.5 / 7.75 / 25 hrs
- Top flashlight: 300 lumens
- 4.35" high



STREAMLIGHT

Underhood Lights



MXN-10183 **\$128⁸⁵**

MaxxBar™ – Hood & Interior Work Light Platform

- Accepts magnetic work lights and supports up to 6 lbs
- Adjustable thermoplastic hood grips
- Expands from 47" to 78"



MLW-2125-20 **\$267⁹⁵**

M12™ Rechargeable Underhood LED Light (Bare Tool)

- Lumens: 1,350/600
- Runtime: 4 hrs/8 hrs
- Telescoping from 47"-78"



AST-151SL **\$206⁸⁵**

Rechargeable Slim Aluminum Underhood Light

- Lumens: 1,510/500 • Runtime: 2.5/6 hrs
- Dimming function
- Telescoping from 45.5" to 82"
- 16 ft. power cable for charging or plugged in use



ATD-80357 **\$357²⁵**

2,000 Lumens 250 SMD LED Corded/Cordless Underhood Light

- 40" light bar provides maximum area illumination
- Large, foam covered hooks extend 55" to 83"
- 25 ft. removable charge cord



ALT-LHR5200 **\$210⁴⁵**

Rechargeable Foldable Underhood Work Light

- Lumens: 2,400/1,200
- Runtime: up to 7 hrs
- Magnetic base tilts and rotates
- USB-C charge port
- USB power bank charges your devices
- Extends up to 78"
- IP54 Water resistant



BAY-SLR-2120 **\$251⁵⁵**

Rechargeable LED Under Hood Work Light/Emergency Area Light

- Lumens: 1,200/650
- Runtime: 4.5/8.5 hrs
- Recharge time: 6 hrs



SHM-SL176R **\$276²⁵**

15W COB LED Rechargeable Under-The-Hood Work Light

- 3 adjustable lamps provide up to 1,200 lumens
- Runtime: up to 840/360 minutes
- Foam-covered handles
- Micro USB charging cable



ATD-80050A **\$265⁵⁵**

1,500 Lumens SMD LED Underhood Light

- Cord: 25 ft. 18/2 SJTOW • Rubber cover
- telescoping brackets extend from 47" to 75"

Penlights / Pocket-Size Lights



6.21" Stylus® LED Penlights

- 6.21" long, long-running penlights
- Constant "on" or momentary blink operation
- Water-resistant, 2m impact resistance
- (3) "AAAA" batteries (included)

Item #	Body	LED	
STM-65018	Black	White	\$29.85
STM-65024	Gold	White	\$29.85
STM-65035	Red	White	\$29.85
STM-65069	Black	UV	\$40.75



Stylus® Reach LED Penlights

- Stylus® penlight with flexible shaft for extra reach
- Constant "on" or momentary blink operation
- Water-resistant, 2m impact resistance
- (3) "AAAA" batteries (included)

Item #	Body	LED	Overall Reach Length	
STM-65418	Black	White	25.5"	\$47.45
STM-65618	Black	White	14"	\$40.75
STM-65612	Silver	White	14"	\$40.75



5.3" Stylus Pro® LED Penlights

- 100 lumens
- Water and 1m impact resistant
- (2) "AAA" batteries (included)

Item #	Body		Item #	Body	
STM-66118	Black	\$43.05	STM-66122	Blue	\$43.05
STM-66120	Red	\$43.05	STM-66128	Orange	\$43.05
STM-66121	Silver	\$43.05	STM-66129	Green	\$43.05



Mini-TAC CREE® LED Flashlights

- Length: 5.4" • Lumens: 100
- Runtime: 1.5 hours
- Beam distance: 44 meters
- (2) AAA batteries (included)

Item #	Colour	
BAY-MT-100	Black	\$38.05
BAY-MT-100BL	Blue	\$38.05
BAY-MT-100R	Red	\$38.05



6" Stylus® Pro USB Rechargeable Penlights

- 350/90 lumens
- Momentary or constant operation
- Water and 1m impact resistance



Item #	Body	Charge Cord	
STM-66133	●	120V AC USB	\$113.15
STM-66134	●	USB	\$100.55
STM-66136	●	120V AC USB	\$113.15
STM-66137	●	USB	\$100.55
STM-66139	●	120V AC USB	\$113.15
STM-66140	●	USB	\$100.55
STM-66145	●	120V AC USB	\$113.15
STM-66144	●	USB	\$100.55
STM-66146	●	USB	\$100.55



3.9" Microstream® USB Ultra-Compact Rechargeable Lights

- Lumens: 250/50
- Water-resistant, 1m impact resistance
- Comes with a lanyard and 5" USB cord

Item #	Body	
STM-66601	●	\$62.65
STM-66602	●	\$62.65
STM-66603	●	\$62.65



6.6" Stylus Pro® COB LED Rechargeable Penlights

- Lumens: 160/40
- Integrated magnet for hands-free use
- Water-resistant, 1m impact resistance
- Includes 19" USB cord

Item #	Body	
STM-66700	●	\$81.45
STM-66703	●	\$81.45
STM-66706	●	\$81.45



STM-66318 **\$36⁸⁵**

3.6" Microstream® Ultra-Compact Battery-Operated Light

- Lumens: 45
- Water resistant, 1m impact resistance
- Comes with a lanyard and (1) "AAA" battery



Penlights / Pocket-Size Lights

STM-88039 **\$62⁶⁵**
5.62" ProTac® 2AAA C4 LED Flashlight
 • Lumens: 130/20
 • Runtime: 1.75 hrs/13 hrs
 • Strobe mode
 • Water and impact resistant
 • Includes (2) "AAA" batteries + holster



STM-88033 **\$87⁷⁵**
6.14" ProTac® 2AA C4 LED Flashlight
 • Lumens: 250/18
 • Runtime: 2 hrs/43 hrs
 • Strobe mode
 • Water and impact resistant
 • Includes (2) "AA" batteries + holster



STM-71500 **\$69⁰⁵**
6.5" Streamlight Jr.® LED AA Battery-Powered Flashlight
 • Lumens: 225
 • Runtime: 6 hrs on alkaline (included), 10 hrs on lithium (optional)
 • (2) "AA" batteries (included)



6" Stylus® Pro USB UV Rechargeable Penlight
 • 400 nanometer UV LED



Item #	Charge Cord	
STM-66148	120V AC USB	\$123.05
STM-66149	USB	\$110.55



MXN-00370 **\$27⁰⁵**
SearchPoint® AMIGO Rechargeable Magnetic Keychain Light
 • Lumens: 700/175 • Runtime: up to 1.5 hrs
 • Inspection and area light modes: P8 LED & COB
 • Attach it to your keys, backpack, toolbox or belt loop
 • Integrated bottle opener • 2m impact resistant
 • Includes USB-C cable
 • Size: 2.75" x 2" x 1"



Pocket Mate™ USB Rechargeable Hands-Free Light
 • Lumens: 325/40
 • Runtime: 20 min / 1 hr
 • Attaches on key ring, zipper, visor, etc.
 • Weather and impact resistant
 • Includes USB cord



Item #	Body	
STM-73300	○	\$41.75
STM-73301	●	\$41.75
STM-73302	●	\$41.75
STM-73303	●	\$41.75



SOL-LNC312 **\$47⁰⁵**
120 Lumens Rechargeable LED Pen Light
 • Dimmer function
 • Magnetic mount
 • USB charge cord



EZR-CT12520 **\$29¹⁵**
6" LED Tactical Light
 • Lumens: 200
 • Runtime: 2.5 hrs
 • Water & impact resistant
 • 2 x AA batteries included



STEELMAN PRO
High Intensity Flexible Bend-A-Light Pro
 • Flexible shaft
 • Cover used as an extension
 • AA batteries included



Item #	Length	
STE-10150A	16"	\$37.55
STE-96285	24"	\$45.05

MXN-04020 **\$44⁷⁵**
3.6" Scout™ Swivel-Head Rechargeable Pocket Flashlight
 • Lumens: 600/180 • Runtime: 2/6 hrs
 • Strobe mode • Magnetic tail cap
 • 90° swivel head
 • Water & impact resistance, IPX3/IK08
 • Includes USB-C charge cord



STM-88052 **\$217⁴⁵**
6.5" ProTac HL® USB Rechargeable C4 LED Tactical Light
 • Lumens: 1,000/380/65
 • Runtime: 1.5/3.5/23 hrs
 • Strobe mode
 • Water and impact resistant • Includes USB cord



Wedge® & Wedge® XT Li-Ion USB-C Rechargeable Flashlights
 • Water and impact resistant
 • Includes USB-C cord and lanyard

Item #	Body	Style	Length	Lumens/Runtime	
STM-88810	●	Wedge®	5.5"	300 lumens, 3 hrs	\$172.55
STM-88811	●	Compact		1,000 lumens, 35 sec. tempor. burst	\$172.55
STM-88812	●	Wedge® XT	4.25"	500 lumens, 2 hrs	\$158.75
STM-88813	●	Ultra-Compact		50 lumens, 11 hrs	\$158.75

Penlights / Pocket-Size Lights

EZR-PCOB **\$16³⁵**
6.25" COB LED Pocket Light with Clip
 • 150 lumens
 • Runtime: up to 7 hrs
 • Magnetic base
 • Operates on 3 AAA batteries



MXN-00440 **\$42⁹⁵**
7" Inspector Maxx Rechargeable Combination LED Work Light / Penlight
 • Floodlight: 250 lumens, 2 hrs
 • Penlight: 160 lumens, 3 hrs
 • Magnetic pocket clip
 • 3 LED battery indicators
 • Rugged aluminum body



MLW-2112-21 **\$99⁹⁵**
6" USB ROVER™ Rechargeable Magnetic Pocket Flood Light
 • 445/100 lumens
 • 2-ft. USB charging cord



Rechargeable SMD LED Pocket Lights
 • Top light: 150 lumens • Runtime: 2hrs/4 hrs
 • USB Type-C cable
 • Wireless charging compatibility (ATD-80206 wireless charger not included)

Item #	Lumens		
ATD-80203	300		\$108.55
ATD-80205	500	! While Qty's. Last	\$138.15



ATD-80206 **\$65⁷⁵**
Wireless Charging Pad



Light Holders

Flexible Light Holders

• Flexible 9" gooseneck bends over 90° and rotates 360°
 • Holds flashlights or trouble lights (from .625" to 2" diameter)



LIS-70450 **\$40⁵⁵**
Spring Clamp



LIS-71070 **\$32³⁵**
Magnetic Base



Rechargeable Flashlights



MLW-2113-21 **\$109⁹⁵**
5.4" USB Rechargeable 110° Pivoting Head Flashlight
 • Spot 500 lumens, 2.5 hrs
 • Flood: 400/100 lumens, 3/10 hrs
 • Magnetic base



6" Rechargeable Dual-Light™ Tactical Flashlight
 • Flashlight: 900/350/150 lumens, 3/6/22 hrs
 • Floodlight: 250 lumens, 3.5 hrs
 • Dual-light: 500 lumens, 2.5 hrs
 • Strobe mode
 • Waterproof and impact resistant
 • Includes a holster



Item #	Body	
BAY-USB-578XL-BL	Blue & Black	\$188.65
BAY-USB-578XL-G	Green & Black	\$188.65
BAY-USB-578XL-R	Red & Black	\$188.65

EZR-CT2205 **\$58³⁵**
7" Dimmable Rechargeable Focusing CREE® LED Tactical Light
 • 200 to 15 lumens, up to 20 hrs
 • Water & impact resistant
 • USB charge cord



EZR-CT2405 **\$65⁶⁵**
7" Rechargeable Focusing CREE® LED Tactical Light
 • 420 lumens, 10 hrs
 • High, low, strobe
 • Water & impact resistant
 • USB charge cord



EZR-CT2505 **\$72⁹⁵**
6.25" Dimmable Rechargeable Focusing Tactical Light
 • 550 to 275 lumens, up to 28 hrs
 • Water & impact resistant
 • USB charge cord



EZR-CT6215 **\$87⁵⁵**
7" Rechargeable Flood & Spot Light
 • Lumens: 700 Spot/100 COB
 • Runtime: up to 48 hrs
 • Dimmable
 • Water & impact resistant
 • USB charge cord



EZR-CT6315 **\$116⁶⁵**
7.6" Rechargeable Flood & Spot Light
 • Lumens: 1,200 Spot/100 COB
 • Runtime: up to 90 hrs
 • Dimmable
 • Water & impact resistant
 • USB charge cord

Rechargeable Flashlights



7" Dualie® Intrinsicly Safe Rechargeable Multi-Function Flashlights with Magnetic Clip

- Spot/flood combo: 275 lumens, 5.5 hrs
- Spot: 180 lumens, 7.25 hrs
- Flood: 105 lumens, 13.5 hrs
- Rugged, integrated magnetic clip
- Dust, water and impact resistant
- 120V/100V AC charger

Item #	Colour	
STM-68793	Yellow	\$151.05
STM-68794	Black	\$151.05



STM-74301 **\$229²⁵** 5.9" Strion® LED Compact, Rechargeable Professional Light

- Lumens: 375/175/80
- Runtime: 2.5/4.75/9.5 hrs
- Strobe mode
- Aluminum body
- AC/DC chargers



STM-75713 **\$253⁸⁵**

8.4" Stinger® LED Rechargeable Flashlight

- Lumens: 425/200/100
- Runtime: 3/5.5/10 hrs
- Strobe mode
- Aluminum body
- AC/DC chargers



STM-88082 **\$120⁸⁵** 5" ProTac® 2L-X USB Flashlight

- High: 500 lumens, 4.5 hrs
- Low: 40 lumens, 30 hrs
- Strobe: 4.5 hrs
- Aluminum body
- (1) SL-B26 USB battery
- (1) USB Cable



STM-88078 **\$241⁶⁵** 7" Protac® HPL USB C4® LED Rechargeable Long Range Tactical Light

- Lumens: 1,000/400/65
- Runtime: 1.5/3/20 hrs
- Aluminum body
- 120V AC/12V DC chargers, USB cable



STM-88095 **\$132³⁵** 4.4" Protac® 90X USB Multi-Fuel Right-Angle Tactical Light

- Lumens: 1000/300/65
- Runtime: 2.5/4/21 hrs
- Strobe mode
- Water & impact resistant
- Removable pocket clip
- Includes charge cord and a USB Li-Ion battery. Also accepts two CR123A batteries.



STM-78101 **\$304⁹⁵** Stinger® 2020 Rechargeable Li-Ion LED Flashlight

- Lumens: 2,000/850/100
- Runtime: 2/4/24 hrs
- Strobe: 3.25 hrs
- Aluminum body
- Textured barrel
- 120V AC/12V DC chargers, 1 holder



STM-88080 **\$211⁴⁵** 9.5" ProTac® HL 5-X USB Flashlight

- High: 3,500 lumens, 1.25 hrs
- Medium: 1,000 lumens, 3 hrs
- Low: 250 lumens, 11.5 hrs
- Aluminum body
- (2) SL-B26 USB batteries
- (1) USB Cable



STM-22051 **\$20⁴⁵** 12V DC Cigarette Lighter Charge Cord

- Model #DC1 charge cord fits most Streamlight® rechargeable bases, holders, and sleeves



MXN-04010 **\$186¹⁵** 5" SearchPoint™ REDZone Rechargeable Flashlight

- Includes white, red, and green lights
- Lumens (white light): 1200/400/35/7
- Strobe mode
- Red light: 165 lumens, 4 hrs
- Green light: 200 lumens, 4 hrs
- Flashing red and green lights
- Aluminum body
- Waterproof
- Includes light diffuser for traffic control, charge cable, lanyard, and holster
- Can also operate on two CR123A batteries (optional)



SOL-LNC330 **\$70⁶⁵** 400 Lumens Dual Function COB LED Rechargeable Flashlight

- COB LED mode: 400 lumens
- Torch mode with pull action zoom: 350 lumens
- Emergency flare work light mode
- Dimmer function
- Magnetic mount
- Includes #18650 battery and USB/Micro USB charge cord



SOL-LNC375 **\$90⁴⁵** 750 Lumens Rechargeable LED Flashlight

- Pull action zoom
- Rechargeable by USB cord or on the wireless charging base
- 5V 2A USB power supply wall charger
- Includes #21700 battery and USB/Micro USB charge cord



Non-Rechargeable Flashlights

MLW-2107S **\$59⁹⁵**



Focusing Flashlight with Holster

- 5.4" long
- Lumens: 325/25 • Runtime: 5/18 hrs
- On/Off/Momentary-on
- Beam distance: 115 meters
- Spot to flood sliding beam adjustment
- Removable metal pocket clip
- Waterproof, dustproof, 4m drop rating
- 3 AAA battery (included)



STM-88047 **\$187²⁵**

ProTac HL® 3 C4 LED Tactical Light

- 7.1" long
- Lumens: 1,100/35 • Runtime: 2 hrs/43 hrs
- Strobe mode • Water and impact resistant
- Includes (3) 3V CR123A lithium batteries + holster



STM-62202 **\$36⁸⁵**



ProPolymer® 3N Battery-Powered LED Flashlight

- 5.25" long
- Lumens: 30 • Runtime: 120 hrs
- Waterproof, 1m impact resistance
- (3) "N" batteries (included)



BAY-NSP-410 **\$37⁷⁵**

Adjustable Beam Flashlight 1AA

- Length: 4.25"
- Lumens: 115 • Runtime: 3 hours
- Waterproof • Drop rating: 2 meters
- 1 AA battery (included)



ProPolymer® 4AA Battery-Powered C4 LED Flashlights

- 7" long
- Lumens: 100, 6 hrs run time
- Waterproof, 1m impact resistance
- (4) "AA" batteries (included)



BAY-NSP-420 **\$44⁰⁵**

Adjustable Beam Flashlight 3AAA

- Length: 4.5"
- Lumens: 275/115/45 • Runtime: 2/5.5/24 hrs
- Beam distance: 133 meters
- Waterproof, impact resistant
- 3 AAA battery (included)



Item #	Body	
STM-68244	Yellow	\$76.75
STM-68344	Black	\$76.75



BAY-XPP-5422GA **\$76⁰⁵**

Intrinsically Safe Permissible Dual-Light™ Flashlight

- Length: 7"
- Flashlight: 120 lumens/17.5 hrs
- Floodlight: 120 lumens/17.5 hrs
- Dual-light: 240 lumens/4.5 hrs
- Beam distance: 170m
- Waterproof, dustproof
- Drop rating: 2m
- Requires 3 AA batteries (not included)



STM-88031 **\$102⁶⁵**

ProTac® 2L C4 LED Flashlight

- 4.77" long
- Lumens: 350/30
- Runtime: 3.25 hrs/35 hrs
- Strobe mode
- Water and impact resistant
- Includes (2) 3V C123A lithium batteries + holster



STM-88850 **\$90⁶⁵**

Polytac® All-Purpose Polymer Flashlight

- 5.34" long
- Lumens: 600/260/35
- Runtime: 2.75 hrs/5.5 hrs/34 hrs
- Strobe mode
- Water and impact resistant
- Includes (2) 3V CR123A lithium batteries



STM-85400 **\$144⁹⁵**

Scorpion® HL C4 LED Flashlight

- 5.46" long
- Lumens: 725/35
- Runtime: 1.25 hrs/18 hrs
- Strobe mode
- Water-resistant
- (2) 3V C123A lithium batteries (included)



Dual-Light™ Flashlights with Dual Magnets

- Length: 7"
- Flashlight: 130 lumens/0.5 hrs
- Floodlight: 110 lumens/10.5 hrs
- Dual-light: 235 lumens/5 hrs
- Beam distance: 181m
- Waterproof
- 3 AA batteries (included)



Item #	Colour	
BAY-NSP-2422B	●	\$57.85
BAY-NSP-2422R	●	\$57.85

Headlamps



STM-61430 **\$48⁸⁵**

QB® USB Rechargeable Ultra-Compact Headlamp

- Spot beam: 200/95 lumens; runs 2/4 hours
- Weather and impact resistant • Includes USB cord



STM-51063 **\$120⁸⁵**

Twin-Task® USB Rechargeable Multi-Function Headlamp

- Spotlight: 375/175/50 lumens; runs 4.75/8.5/20 hours
- Flood light: 250/125 lumens; runs 5/9 hours
- 120° tilting head
- Water and impact resistant • Includes USB cord



STM-61052 **\$63⁹⁵**

Septor® 7 LED Headlamp

- Lumens: 120/45/13
- Runtime: 3.4 hrs/10 hrs/55 hrs
- 60m beam distance
- 90° tilting head
- Water and impact resistant
- (3) "AAA" batteries (included)



STM-61301 **\$62⁶⁵**

Argo® Long-Range LED Headlamp

- Lumens: 150/100/45
- Runtime: 3 hrs/4.5 hrs/30 hrs
- 190m beam distance
- 90° tilting head
- Water and impact resistant
- (3) "AAA" batteries (included)



STM-61700 **\$44⁷⁵**

Bandit® Ultra-Compact, Low-Profile USB Rechargeable Headlamp

- Floods work area with light; ideal for up-close tasks
- Lumens: 180/35 • Runtime: 2 hrs/9.5 hrs
- Emergency flash mode • Water and impact resistant
- Includes USB cord + hat clip



Bandit® Pro Bright USB Rechargeable Headlamp

- High: 180 lumens; runs 4.5 hrs
- Low: 35 lumens; runs 21 hrs
- Emergency flash: 180 lumens
- IPX4 weather and impact resistant
- Includes visor clip
- Includes USB cord



Item #	Colour	
STM-61710	Yellow	\$48.85
STM-61714	Black	\$48.85



MLW-2163-21 **\$83⁵⁵**

USB Rechargeable Hard Hat Headlamp

- Lumens: 600
- 5 light output modes
- Light head rotates 180°
- Water, dust & impact resistant
- Includes (4) clips, (1) USB battery and (1) USB cable



MLW-2115-21 **\$84³⁵**

Low Profile USB Rechargeable Hard Hat Headlamp

- Lumens: 600/350/125/25
- Runtime: 2/6/10/27 hrs
- 1" Ultra-thin light head
- Includes hard hat clips and USB cable



EZR-CT4200 **\$51⁰⁵**

Focusing Headlamp

- Lumens: 220
- Runtime: up to 7 hrs
- Beam distance: 120m
- High, low, strobe
- Adjustable angle head
- Water & impact resistant



EZR-CT4205 **\$102¹⁵**

CREE® LED Rechargeable Focusing Headlamp

- Lumens: 380 • Runtime: up to 10 hrs
- Beam distance: 120m
- High, low, strobe
- Adjustable angle head
- Rear hazard light
- Water & impact resistant
- Micro USB charge cord



EZR-CT4305 **\$102¹⁵**

High Power LED Rechargeable Focusing Headlamp

- Lumens: 800/400 • Runtime: up to 8 hrs
- Beam distance: 150m
- High, low, strobe
- Adjustable angle head
- Rear hazard light
- Water & impact resistant
- Includes micro USB charge cord



Headlamps

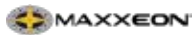

MXN-00640 **\$78⁷⁵**
WorkStar® LightVisor™
Rechargeable Headlight

- Lumens: 600/300 • Runtime: 6.5 hrs/3 hrs
- 130° beam angle • IP 65 water resistant; Shock resistant, up to 6 ft. (2m)
- Charge indicator: 25%, 50%, 75%, 100%
- Includes USB-C charge cable • Charge time: 4.5 hours



MXN-00500 **\$55⁸⁵**

WorkStar® 500 DROID Technician's
Rechargeable Mini Headlamp with Tilt

- Lumens: 400 / 160 • Runtime: 2 / 5 hours
- Beam distance: 38m / 24m • USB charge cord included



BAY-NSP-4602B **\$31¹⁵**

Dual-Light™ CREE® LED
Headlamp

- Spotlight: 30 lumens, 15 hrs
- Floodlight: 15 lumens, 36.5 hrs
- Dual-light: 35 lumens, 12 hrs
- Beam distance: 19 meters
- Waterproof and 2m impact resistant
- 3 AAA batteries (included)



BAY-NSP-4604B **\$44⁰⁵**

Dual-Light™ CREE® LED
Headlamp

- Spotlight: 100 lumens, 7 hrs
- Floodlight: 45 lumens, 8 hrs
- Dual-light: 90 lumens, 8.5 hrs
- Beam distance: 93 meters
- Waterproof and 2m impact resistant
- 3 AAA batteries (included)



ATD-80250A **\$68²⁵**

COB LED Rechargeable
Motion Activated
Headlamp

- Flood light: 200/100 lumens; 2.5/5 hrs
- Spot light: 120 lumens; 3 hrs
- Pivoting light head
- Adjustable and removable head band with hard hat clips
- Dust and water resistant
- Micro-USB charge cord



SOL-LNC7250 **\$57⁶⁵**

CREE® LED Rechargeable
Motion Activated Headlamp

- Spotlight: 200 lumens
- Flood light: 250 lumens
- Up to 8 hours run time
- Hands-free wave on/off
- Dimmer feature
- Micro-USB charge cord



STE-78834 **\$54²⁵**

Slim Profile Rechargeable
Multi-Mode 10 SMD LED
Headlamp

- High/Medium/Low output: 250 lumens, 3 hrs, 20m
- 120 lumens, 4.5 hrs, 15m
- 60 lumens, 9 hrs, 10m
- Water resistant casing
- Li-Ion rechargeable battery



Neck Lights



MLW-2117-21 **\$139⁹⁵**

Rechargeable Neck Light

- Lumens: 400 • Runtime: 8+ hrs
- 2 modes to manage output
- Light head with 130° of vertical rotation
- Ergonomic, sweat resistant band
- Dust and water resistant • 6 ft. impact resistant
- Includes USB-C cable & REDLITHIUM™ USB 3.0 battery



Anywear™ Multi-Position
LED Neck Lights

- Attractive sleek design and more comfortable than conventional headlamps
- Light rotates up and down up to 70°



Rechargeable Neck Lights

- Lumens: 300/30
- Includes USB charging cord

Item #	Colour	
EZR-NK15	●	\$81.95
EZR-NK15-GR	●	\$81.95
EZR-NK15-OR	●	\$81.95



EZR-CT7100 **\$35²⁵**

Battery-Operated LED Neck Light

- Lumens: 200/100
- Run time: 2.5 hrs/5 hrs
- Operate each light head independently
- Light heads pivot up and down 90°
- Includes 2 AA batteries



Scan Tools & Accessories

MS906PRO



FREE!

Buy #AUL-MS906PRO and obtain #AUL-BT506 for free: Battery & Electrical System Tester.



MS906PROTS



FREE!

Buy #AUL-MS906PROTS and obtain #AUL-TBE200 for free: MaxiTPMS Laser-Enabled Tire Tread Depth & Brake Disc Wear Analysis Tool.



AUTEL MAXISYS

Passenger & Light Duty Vehicle Scan Tool Tablets

	AUL-MS906PRO	AUL-MS906PROTS
	Advanced Diagnostics	Advanced Diagnostics + TPMS Diagnostics & Service
HARDWARE		
Wireless Vehicle Connection	Bluetooth MaxiSYS VCI200	Bluetooth MaxiSYS VCI200
Colour Touchscreen	8" LED	8" LED
Processor	2.3 GHz + 1.7 GHz Octa-Core	2.3 GHz + 1.7 GHz Octa-Core
Memory / RAM	128GB SSD + 4GB RAM	128GB SSD + 4GB RAM
Internal Battery	11,600 mAh	11,600 mAh
Accessory Ports	HDMI & USB	HDMI & USB
Connection to the Optional #MP408 Oscilloscope	✓	✓
Connection to the Optional #BT506 Battery & Electrical System Tester	✓	✓
Non-OBDII Connectors	Optional Kit: #AUL-MSOBD2KIT	Optional Kit: #AUL-MSOBD2KIT
SOFTWARE		
Operating System	ANDROID 7.0	ANDROID 7.0
Software Updates	1 Year FREE	1 Year FREE
Automatic Detection	Auto-VIN / Auto-SCAN SCAN VIN / PLATE SCAN	Auto-VIN / Auto-SCAN SCAN VIN / PLATE SCAN
Secure Gateway Access	Authorized FCA Access with AutoAuth Account	Authorized FCA Access with AutoAuth Account
License Plate Reader	Available on Supported Vehicles	Available on Supported Vehicles
FEATURES		
Basic & Special Functions	Domestic, Asian & Euro 1996 and Newer	Domestic, Asian & Euro 1996 and Newer
OBDII Test Modes	All 10 Test Modes Live & Freeze Frame / Enhanced Mode 6	All 10 Test Modes Live & Freeze Frame / Enhanced Mode 6
TPMS Service Modes	Register Sensor IDs	Activate / Relearn / Program MX-Sensors
Service Resets	26 Service Features	26 Service Features
Diesel (Light & Medium Duty)	Reset Diesel Emissions	Reset Diesel Emissions
System Diagnostics	Access All Modules in All Systems	Access All Modules in All Systems
Component Activations	Bi-Directional Control	Bi-Directional Control
Enhanced Functions	Advanced Coding + Adaptations	Advanced Coding + Adaptations
ADAS Calibration	ADAS Calibration-Capable with Software Upgrade & Autel Calibration System Purchase	ADAS Calibration-Capable with Software Upgrade & Autel Calibration System Purchase
Battery Analyzation	MaxiBAS Software Purchase of BT506 required to use MaxiBAS software	MaxiBAS Software Purchase of BT506 required to use MaxiBAS software
Complete TPMS Function		TPMS Diagnostics, Service & 1-Sensor Programming

DIAGNOSTIC & TESTING SERVICE TOOLS

Scan Tools & Accessories

FREE!
Buy #AUL-MS909 and obtain #AUL-IR100 for free: MaxiIRT Thermal Imaging Camera, -20°C to 450°C (-4°F to 842°F).

FREE!
Buy #AUL-MS919 and obtain #AUL-IR100 for free: MaxiIRT Thermal Imaging Camera, -20°C to 450°C (-4°F to 842°F).

FREE!
Buy #AUL-MSULTRA and obtain #AUL-IR100 for free: MaxiIRT Thermal Imaging Camera, -20°C to 450°C (-4°F to 842°F).

MSULTRA



Passenger & Light Duty Vehicle Scan Tool Tablets

	AUL-MS909	AUL-MS919	AUL-MSULTRA
	Next Generation Diagnostics	Next Generation Diagnostics	Next Generation Diagnostics
HARDWARE			
Wireless Vehicle Connection	MaxiFlash VCI Including Latest Protocols	MaxiFlash VCMI Including Latest Protocols	MaxiFlash VCMI Including Latest Protocols
Colour Touchscreen	10" LCD	10" LCD	13" LCD
Processor	2.3 GHz + 1.7 GHz Octa-Core	2.3 GHz + 1.7 GHz Octa-Core	2.3 GHz + 1.7 GHz Octa-Core
Memory / RAM	128GB SSD / 4GB RAM	128GB SSD / 4GB RAM	256GB SSD / 4GB RAM
Internal Battery	15,000 mAh	15,000 mAh	18,000 mAh
Accessory Ports	HDMI / 2 USB	HDMI / 2 USB	HDMI / 2 USB + Docking Station
Non-OBDII Connectors	Optional (#MSOBD2KIT)	Optional (#MSOBD2KIT)	Optional (#MSOBD2KIT)
SOFTWARE			
Operating System	ANDROID 10.0	ANDROID 10.0	ANDROID 7.0
Software Updates	1 Year FREE	1 Year FREE	1 Year FREE
Automatic Detection	SCANVIN / Auto-VIN / Auto-SCAN / Plate Scan	SCANVIN / Auto-VIN / Auto-SCAN / Plate Scan	SCANVIN / Auto-VIN / Auto-SCAN / Plate Scan
Split Screen Display			View Multiple Functions At Once
Advanced VCMI 5-in-1 Device		VCI, Oscilloscope, Multimeter, Waveform Generator, CAN Bus Check	VCI, Oscilloscope, Multimeter, Waveform Generator, CAN Bus Check
Repair Assist	Guided Procedures with DTC Analysis & Fault Code Solutions	Guided Procedures with DTC Analysis & Fault Code Solutions	Guided Procedures with DTC Analysis & Fault Code Solutions
Topology Module Mapping	Colour Coded All System Status Screen on supported vehicles	Colour Coded All System Status Screen on supported vehicles	Colour Coded All System Status Screen on supported vehicles
Relevant Cases	DTC Troubleshooting	DTC Troubleshooting	DTC Troubleshooting Repair Tips Video Library
Technical Service Bulletins	Available on Select Vehicles	Available on Select Vehicles	Available on Select Vehicles
Secure Gateway Access	Authorized FCA Access with AutoAuth Account	Authorized FCA Access with AutoAuth Account	Authorized FCA Access with AutoAuth Account
License Plate Reader	Available on Supported Vehicles	Available on Supported Vehicles	Available on Supported Vehicles
FEATURES			
Basic & Special Functions	Domestic, Asian & Euro 1996 and Newer	Domestic, Asian & Euro 1996 and Newer	Domestic, Asian & Euro 1996 and Newer
OBDII Test Modes	All 10 Test Modes Live & Freeze Frame / Enhanced Mode 6	All 10 Test Modes Live & Freeze Frame / Enhanced Mode 6	All 10 Test Modes Live & Freeze Frame / Enhanced Mode 6
TPMS Service Modes	Register Sensor IDs	Register Sensor IDs	Register Sensor IDs
Service Resets	36 Service Features	36 Service Features	36 Service Features
Diesel (Light & Medium Duty)	Reset Diesel Emissions	Reset Diesel Emissions	Reset Diesel Emissions
System Diagnostics	Access All Modules in All Systems	Access All Modules in All Systems	Access All Modules in All Systems
Component Activations	Bi-Directional Control	Bi-Directional Control	Bi-Directional Control
Enhanced Functions	Advanced Coding + Adaptations	Advanced Coding + Adaptations	Advanced Coding + Adaptations

Scan Tools & Accessories

MS909EV & MSULTRAEV INTELLIGENT EV DIAGNOSTICS



Intelligent EV Diagnostics Tablets

- Secure high-voltage system testing and analysis
- Advanced diagnostics for U.S., European and Asian electric, gas & diesel, and hybrid vehicles

	AUL-MS909EV	AUL-MSULTRAEV
HARDWARE		
Wireless Vehicle Connection	Bluetooth MaxiFlash VCI	Bluetooth MaxiFlash VCMI
Colour Touchscreen	10" LCD	13" LCD
Processor	2.2 GHz + 1.8 GHz Octa-Core	2.2 GHz + 1.8 GHz Octa-Core
Memory / RAM	128GB SSD / 4GB RAM	256GB SSD / 4GB RAM
Docking Station		Included
EVDiag Box	Included	Included
SOFTWARE		
Operating System	ANDROID 10.0	ANDROID 7.0
Split Screen Display		View Multiple Functions At Once
High-Voltage System Diagnostics	Diagrams of High-Voltage System Block	Diagrams of High-Voltage System Block
Battery Pack Diagnostics	SOC and SOH Analysis	SOC and SOH Analysis
Advanced VCMI 5-in-1 Device		VCI, Oscilloscope, Multimeter, Waveform Generator, CAN Bus Check
Secure Gateway Access	Authorized FCA Access with AutoAuth Account	Authorized FCA Access with AutoAuth Account
FEATURES		
Service Resets	36 Service Features	36 Service Features
Diesel (Light & Medium Duty)	Reset Diesel Emissions	Reset Diesel Emissions

AUTEL MAXISYS

AUL-EVDIAGKIT



EV Diagnostics Upgrade Kit

- Includes EVDiag Box, software, and adapters for specific vehicles to achieve battery packs diagnostics for electric vehicle
- Compatible with the MaxiSys Ultra, MaxiSys Ultra ADAS, MaxiSys MS919, and MaxiSys MS909

BATTERY PACK DIAGNOSTICS

- In-depth battery pack diagnostics for the most popular EV vehicles on the market including BMW, Tesla, and VW/Audi
- State of Charge and State of Health analysis for true battery condition



MaxiSYS 1-Year Total Care Program Cards



1-YEAR LIMITED WARRANTY COVERAGE EXTENSION

- Renew tablet coverage year after year
- Cover device failure (certain fees may apply for device replacement)
- Contact Tech Support remotely from tool

1-YEAR SOFTWARE UPDATES EXTENSION

- New tool features and functions
- Most up-to-date coverage for old and new vehicles

Item #	Tool Coverage
AUL-MS906BT1YRUPDATE	MS906BT
AUL-MS906CV1YRUPDATE	MS906CV
AUL-MS906TS1YRUPDATE	MS906TS
AUL-MS906S1YRUP	MS906S
AUL-MS906P1YRUP	MS906PRO
AUL-MS906PT1YRUP	MS906PROTS
AUL-MS9081YRUPDATE	MS908
AUL-MS908CV1YRUPDATE	MS908CV
AUL-MS9091YRUPDATE	MS909
AUL-MS909CV1YRUP	MS909CV
AUL-MS9191YRUPDATE	MS919
AUL-MSELite1YRUPDATE	MSElite
AUL-MSULTRA1YRUPDATE	MSULTRA & MSULTRAEV



AUTEL

\$1567⁶⁵

AUL-MFVCIKIT

MaxiFlash Bluetooth VCI/J2534 Pass-Thru Programmer Kit



- Compatible with the MaxiSys MS909 advanced diagnostic tablet
- Use with Windows PC for vehicle module programming, J2534-1 & J2534-2 compliant
- Program compatible BMW & Mercedes vehicle modules
- Includes main cable V2.0, USB 2.0 cable, and AC/DC adapter
- Supports CAN FD, 4 CAN Channels, and DoIP
- Supports D-PDU, IS O22900-1 & ISO 22900-2
- RP1210 compliant

\$195⁰⁵

AUL-TESKIT

TESLA Diagnostics Cable Kit



- Set of three cables enables MaxiSys tablet users to connect with Tesla S and X vehicles to activate factory mode and perform system diagnostics
- Cables compatible with Autel MaxiSys tablets

AUL-CANFD-ADAPT

\$158³⁵

CAN FD Protocol Adapter

- Supports GM and Ford vehicles 2019 and later with CAN FD capability
- Compatible with: MX808, MS905, MS906, MS906BT, MS906TS, MS908, MS908S, MS908P, MS908SP, MSELITE, IM508, IM608
- Compatible with supported Autel VCI units



DIAGNOSTIC & TESTING SERVICE TOOLS

Key Programming

AUTEL MAXIIM

For more information, scan the QR Code, or visit: g2stobeq.ca/autelikeys



MaxiIM IKEY – Programmable Smart Keys

- The Autel IKEY is a universal programmable smart key that can be programmed to replace smart keys for more than 700 vehicles including those made by Hyundai, Nissan, Chrysler, Honda, General Motors, and select vehicles made by BMW, Audi/VW, and Volvo
- The IKEY is OE-quality, multi-frequency (315M/415M and 868M/915M) programmable smart key that supports two to seven button configurations
- Supports ultra-long range (40m/130 feet) frequency transmission
- Use the KM100 tablet to program the IKEY for supported vehicles in as little as a minute
- **Each key is sold individually, batteries not included (CR2032)**
- RAZOR & PREMIUM models: Emergency bladed key included



AUTEL MAXIIM

AUL-KM100 **\$670⁵⁵**

Universal Key Generator Kit

- Combines OBD IMMO programming, universal key generating, key renewal, transponder editing and other services in one Android 9.0 based 5.5" tablet with 2Gb RAM & 64Gb on-board memory
- It can be paired with Autel IKEY to provide professional key programming solutions
- Includes 2 IKEYs, programmable smart key replacement for more than 700 vehicles
- 60-second key generation (Autel Universal only)
- Transponder reading/writing/cloning
- Frequency detection & ignition coil detection
- Compatible with Autel blank universal smart keys
- Key renewal: supporting 36 vehicle makes
- Dual-band, high frequency
- Supporting PLC V200
- Supporting AutoVIN



AUTEL MAXIIM

AUL-IM608PROIIKPA

Advanced IMMO & Key Programming Bundle

- Program IMMO & Keys for US, Asian and European vehicles
- Advanced diagnostics functions and advanced service functions

IMMO & Key Programming:

- Read immobilizer pins & password directly from vehicle
- Store vehicle information to use when learning new keys
- Smart mode for guided and automated key learning
- Read Pin/Cs (all keys lost), key generation, key learning, remote learning
- IMMO ECU reset/adaptation, refresh/coding
- Transponder read/write, EEPROM/MCU read/write
- Expert mode for advanced key learning
- Use to program IKEYS (sold separately)

Kit includes:

- MaxiIM IM608PROII 10.1" Android touchscreen tablet
- MaxiFlash JVCi wireless J2534 Pass Thru programming device
- XP400Pro advanced key and chip programmer (also sold separately)
- IMKPA key programming adapter kit (also sold separately)



AUTEL MAXIIM

AUL-IM508S

Key Fob Programmer, IMMO & Diagnostics Tablet

- The IM508S, an all-systems code reader and service tool, offers powerful IMMO functionality including backup, restore, adaptations and coding, key generation and key learning & remote learning
- 7" touchscreen Wi-Fi tablet
- Use to program Autel's line of IKeys (sold separately)
- Smart Mode for guided and automated key learning
- Expert Mode for advanced key learning
- Read PIN/CS (all key lost), key generation, key learning, remote learning
- IMMO ECU reset/adaptation, refresh/coding
- All systems diagnostics for US, Asian and European vehicles, 1996+
- Advanced maintenance services including EPB, DPF, SAS, Oil reset, and BMS
- Includes the XP200 key programmer



AUL-XP400PRO **\$807²⁵**

XP400 PRO – Advanced All-in-One Key & Chip Programmer

- Reads/writes and learns keys to the vehicle
- Performs EEPROM-data functions needed for European vehicles
- Enables programming of infrared keys for Mercedes vehicles and IC chip keys on late model Hyundai and Kia vehicles
- Supports data read/write of 3,000+ chip types (EEPROM, engine ECU, MCU, IMMO ECU)
- Compatible with #IM508 and #IM608



AUL-APB112 **\$336³⁵**

APB112 – Smart Key Emulator

- Compatible with IM608, IM508 & MX808IM
- Compatible with XP400
- 4 smart key password calculation
- 46 chip simulation
- Collects data from ignition coil
- Identify ignition coil troubles
- Decode vehicle key chip data
- Must be used with an Autel diagnostic tool



IDENTIFY → CUT → PROGRAM



NIT-20426059 

Complete Key Making System (Without Programmer)

- Includes the hardware necessary to cut car keys, but also contains keys and remotes for the most common vehicle types you are likely to encounter on the road.
- These OEM-like keys can be programmed by any programmer. (Programmer sold separately).
- Includes: 1 x #20201002; 1 x #27301238; 1 x #27801294



NIT-27301238 **\$4129⁶⁵**

Remote & Smart Key Bundle

Includes 172 of the most popular and profitable remotes and keys found in North America:

- 21-Pc **Ford Remotes** (#27301231)
- 26-Pc **Chrysler Remotes** (#27301232)
- 27-Pc **GM Remotes** (#27301233)
- 27-Pc **Toyota/Lexus Remotes** (#27301234)
- 28-Pc **Honda/Acura Remotes** (#27301235)
- 23-Pc **Nissan Remotes** (#27301236)
- 20-Pc **Hyundai/Kia/Mazda/Mitsubishi Remotes** (#27301237)



NIT-27801294 **\$909¹⁵**

Transponder Key Set (Heads, Blades and Chips)

- Assemble hundreds of automotive transponder keys with this single set.
- Use as **TEST KEYS**: Using the reusable, blue universal head, cut these inexpensive blades and test in the lock before duplicating onto a more expensive transponder key or remote head key
- Use as **PLASTIC-HEADED KEYS**: Combine these blades with the appropriate key heads to give your customer a permanent, high quality mechanical key
- Use as **TRANSPONDER KEYS**: The same key heads also work as a transponder key. Just insert the right chip and program it

The kit includes:

- **Key Blades** (240 blades)
- **Transponder Key Heads** (77 heads, 16 types)
- **Transponder Chips** (80 chips)

NIT-20201002 

Triton PLUS Key Cutting Machine – Automotive Edition

- Cuts 99% of automotive, commercial and residential keys
- Easily duplicate keys with interactive, on-screen illustrated instructions
- Automated cutting for quick and accurate key making every time
- 7" touchscreen with crisp graphics and an intuitive menu
- Contains a comprehensive database
- Custom search functions include the ability to search by vehicle model, keyway, or IC card number
- Unlimited, free updates for the life of your machine via Wi-Fi
- 3-year warranty

DIAGNOSTIC & TESTING SERVICE TOOLS

Wheel Alignment & ADAS Calibration

AUTEL MAXISYS IA900WA

Intelligent ADAS IA900WA Frame that Performs 4-Wheel Alignment & ADAS Calibration

- 24" touchscreen monitor
- Simulcast from MaxiSYS Ultra
- Maxisys™ interface instead of PC for wheel alignment
- Precise optical measurement with 6 high resolution cameras
- Self calibrating cameras, always accurate, every time
- Robotic frame movement for efficient use and alignment reading accuracy
- Cameras automatically track vehicle height on lift



Item #		IA900WA FRAME STATIONARY	MAXISYS ULTRA ADAS & MAXIFLASH VCMI	ADAS SOFTWARE	LDW	AVM	BSD	ACC	LIDAR	NVS	RCW
AUL-IA900LDW	ADAS IA900WA Wheel Alignment with LDW Targets		—	—		—	—	—	—	—	—
AUL-IA900LDWT	ADAS IA900WA Wheel Alignment with LDW Targets + ULTRA ADAS Tablet					—	—	—	—	—	—
AUL-IA900AS	ADAS IA900WA Wheel Alignment with ALL SYSTEMS Calibration		—	—							
AUL-IA900AST	ADAS IA900WA Wheel Alignment with ALL SYSTEMS Calibration + ULTRA ADAS Tablet										

ADAS

AUTEL MAXISYS ADAS

ADVANCED DRIVER ASSISTANCE SYSTEM

SYSTEM COVERAGE

- Adaptive Cruise Control (ACC)
- Around View Monitoring (AVM)
- Blind Spot Detection (BSD)
- Lane Departure Warning (LDW)
- Light Imaging Detection and Ranging (LIDAR)
- Night Vision System (NVS)
- Rear Collision Warning (RCW)

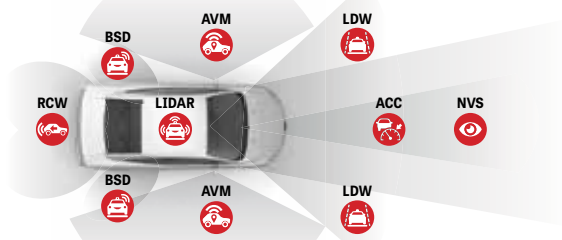

Item #		STANDARD FRAME STATIONARY	MA600 FRAME PORTABLE	MAXISYS MS909 & MAXIFLASH VCI	ADAS SOFTWARE	ACC	AVM	BSD	LDW	LIDAR	NVS	RCW
AUL-AS20	ADAS ALL SYSTEMS 2.0		—	—								
AUL-AS20T	ADAS ALL SYSTEMS 2.0T		—									
AUL-MAS20	MA600 ALL SYSTEMS 2.0	—		—								
AUL-MAS20T	MA600 ALL SYSTEMS 2.0T	—										

AUL-IA800

Intelligent ADAS Optical Positioning System Expansion Package

- Compatible with the MaxiSYS ADAS Standard Calibration Frame (not included)
- Frame positioning in as little as 1 minute
- 6 high resolution cameras that provide 3-dimensional adjustment
- 4 wheel clamp targets for alignment verification, plus other targets and accessories

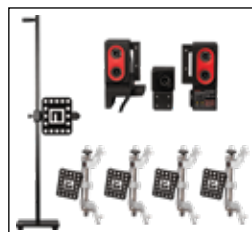

AVM Floor Patterns

- Each sold separately
- AVM patterns work with MA600 and ADASCOMPLETE calibration packages



Item #	Applic.
AUL-CSC1004-05	Ford
AUL-CSC1004-01	VW
AUL-CSC1004-07	Porsche

ADAS

NEW

AUTEL

\$1311⁵⁵

AUL-ATS100
**CV ADAS
Radar Sensor –
Blind Spot/
Turn Assist
System for
Commercial Vehicles**



• **Helps improve vehicle safety by alerting drivers to potential collisions in their vehicle's blind spot**

- Complete solution with Sensor & Display
- Compatibility with 99.5% of commercial vehicles, buses, trucks, trailers, and tractors
- 180° field of view
- 120 ft. (37m) pedestrian & cyclists detection
- Up to 260 ft. (80m) detection range
- Low false warning rate
- Distinguishes between moving and non-moving vehicles

• **Two sensing modes:**

Low Speed for turn assist and pedestrian & cyclist detection;

High Speed for lane change assist, active vehicle warning

- Plug & Play, no vehicle signal input needed, only power supply
- Auto-calibration



ESI-904 **\$97²⁵**

**Code Buddy PRO+
OBDII Code Scanner**

- Supports all protocols including CAN
- Displays trouble codes and definitions
- Reads LIVE DATA STREAM
- Displays I/M readiness
- Retrieves vehicle information (VIN, CIN & CVN)
- Clears codes, turns off MIL and resets monitors



Code Readers/Code Scanners

AUTEL

**AutoLink
Code Readers**

- OBDII connection
- Internet updateable
- Free software updates for life of tool



	AUL-AL329 1 System Affordable Code Reader	AUL-AL529 Code Reader + Special Functions
HARDWARE		
Memory		16GB Micro SD Card
Print Data	USB Cord to PC	USB Cord to PC
One Click I/M Readiness	Quick Key Indicator Lights	Quick Key Indicator Lights
FEATURES		
Emissions Testing	I/M Readiness	I/M Readiness O2 & Onboard Monitor
OBDII Test Modes	Live Data & Freeze Frame Data	All 10 Test Modes Live & Freeze Frame / Enhanced Mode 6
MIL	Read MIL Status	Read MIL Status
Data Historical		Save & Playback
Testing		Component Test
Mode 6		Enhanced
DTCs Help		On-Tool
Read/Erase DTCs	Engine	Engine
Read/Erase Manufacturer-Specific Codes		Enhanced Power System Codes on GM/Ford/Chrysler
	\$50.45	\$160.45



**All Systems Code Readers &
Service Tools**

- OBDII connection

	AUL-MD808P	AUL-MX808	AUL-MX900
	MaxiDiag Service + Essential Systems Tool	MaxiCheck Advanced All Systems/ Service Tablet	MaxiCheck Advanced All Systems/ Service Tablet
HARDWARE			
Screen	4"	7" Touchscreen	8" Touchscreen
Memory	32GB Micro SD Card	32GB SSD / 2GB RAM	64GB ROM / 4GB RAM
Print Data	USB to PC	WiFi to PC	WiFi to PC
Reports		Generate Repair Reports	Generate Repair Reports
SOFTWARE			
Operating System		ANDROID 4.4	ANDROID 11
Software Updates	FREE for Lifetime of Tool	1-Year FREE	1-Year FREE
FEATURES			
Emissions Testing	I/M Readiness O2 & Onboard Monitor	I/M Readiness O2 & Onboard Monitor	I/M Readiness O2 & Onboard Monitor
OBDII Test Modes	All 10 Test Modes Live & Freeze Frame / Enhanced Mode 6	All 10 Test Modes Live & Freeze Frame / Enhanced Mode 6	All 10 Test Modes Live & Freeze Frame / Enhanced Mode 6
Service Resets	6 Service Functions	17 Service Functions	40 Service Functions
OLS/EPB/SBC/SAS/BMS	■	■	■
DPF Regeneration	■	■	■
TPMS Sensor Relearn		■ (Activation Tool Required)	■ (Activation Tool Required)
IMMO Functions		■	■
ABS Brake Bleed		■	■
	\$437.25	\$616.65	\$762.45

DIAGNOSTIC & TESTING SERVICE TOOLS

TPMS Diagnostic & Service Tools

700010
(Model #TS508WFK)



700180
(Model #TS508WFK-4)



700020
(Model #TS508WFK-1)



700040
(Model #TS608K-1)



AUTEL MaxiTPMS - TPMS Diagnostic Tools

	AUL-700010	AUL-700180	AUL-700020	AUL-700040
	#TS508WF Advanced TPMS Service Tool with Wi-Fi	#TS508WF Advanced TPMS Service Tool with Wi-Fi + (4) Rubber 1-Sensors	#TS508WF Advanced TPMS Service Tool with Wi-Fi + (8) Rubber 1-Sensors	#TS608 Complete TPMS + All Service + All Systems + (8) MX-Sensor 1-Sensor
HARDWARE				
Connection	OBDII Cable		Wireless Bluetooth MaxiVCI MINI	
LED Colour Screen	2.3-inch / 320 x 240 DPI		7-inch Touchscreen 1024 x 600 DPI	
Processor			1.6 GHz Quad-Core	
Memory			32GB SSD / 1GB RAM	
Accessory Ports			HDMI / USB	
TPMS SENSOR				
TPMS Diagnostics	TPMS Status Screen		Enhanced TPMS Status Screen	
Read/Activate/Relearn	All Known Sensor Brands		All Known Sensor Brands	
Programming Methods	4 Methods MX-Sensors Only		4 Methods MX-Sensors Only	
Relearn Procedures	Display Vehicle-Specific Relearn Procedures / Perform OBDII Relearns		OBDII Relearn	
TPMS Tool-Kit App			TPMS Special Functions	
SOFTWARE				
Software Updates (Internet)	FREE for Life of Tool Wi-Fi to PC		1 Year FREE Wi-Fi	
Repair & Test Data	Access 1 Previous Record		Access All Records	
Automatic Detection			Auto-VIN / Auto-SCAN	
TPMS Service Functions	Advanced TPMS		Complete TPMS	
Service Resets			20 Service Functions Standard Features	
System Diagnostics			Essential Diagnostics All Modules in All Systems	
	\$321.15	\$370.05	\$470.95	

AUTEL

AUL-1-SENSOR **\$26²⁵**

Programmable Universal TPMS MX-Sensor 1-Sensor with Press-In Rubber Valve Stem

- Exclusive press release button to easily replace valve stems
- Combined Frequency: 315MHz & 433MHz
- Programmable with Autel TPMS service tools
- Compatible with Autel interchangeable rubber, aluminum or colour metal valve stems



Adjustable Angle MX-Sensor 1-Sensor

- Programmable universal TPMS sensor with screw-in valve stems
- 15° of valve stem flexibility fits a wider variety of vehicles
- Combined frequency: 315MHz & 433MHz
- Programmable with Autel TPMS service tools



Item #	Stem	
AUL-300020	Rubber	\$42.45
AUL-300030	Aluminum	\$42.45

AUL-300100 **\$82⁵⁵**

Pre-Programmed MX-Sensor BLE Bluetooth TPMS Sensor for Tesla 3/Y/S/X Models

- Tesla-ready pre-programmed Bluetooth Low Energy (BLE) TPMS sensor for Tesla 3/Y/S/X models: **just fit and go**
- Programmable with Autel TS900, ITS600 and ITS600PRO TPMS tools for the latest BLE-equipped vehicles
- Built to meet industry standards
- 15°-34° adjustable angle valve stem to meet various vehicle needs
- Battery life of 6-plus years
- Tested to endure extreme temperatures



TPMS Diagnostic & Service Tools

AUTEL

1-Pc Replacement Press-In Metal Valve Stems for Autel MX-Sensor 1-Sensor

Item #	Stem	
AUL-CV-001	Black	\$4.55
AUL-CV-002	Titan Grey	\$4.55
AUL-CV-003	Chrome	\$11.45



Set of 4 Replacement Press-In Valve Stems for Autel MX-Sensor 1-Sensor

Item #	Stem	
AUL-MXSENSORRVK	Rubber	\$11.05
AUL-MXSENSORMVK	Metal	\$11.05



AUTEL



MaxiTPMS ITS600 Series – Tablet-Style TPMS Tools

- Optical scanner identifies VIN/MMY
- Exclusive TPMS status screen
- Fast OBDII relearn for most US domestic vehicles
- Batch program up to (20) 1-Sensors
- Activate, read, relearn all known TPMS sensors
- Tire pressure placard value reset
- Includes 4 commonly used maintenance service functions: EPB, Oil Reset, BMS, SAS
- Tools come with V200 Bluetooth VCI unit

Item #	Description	
AUL-ITS600	ITS600 Kit with Bluetooth VCI only	\$706.35
AUL-700130	ITS600K8 with Bluetooth VCI + (8) 1-Sensors	\$982.55
AUL-700140	ITS600K20 with Bluetooth VCI + (20) 1-Sensors	\$1269.55
AUL-700150	ITS600 Pro Kit with Bluetooth VCI and Diagnostics for All Models and All Systems	\$872.15

ATQ-VT5S **\$72¹⁵** TPMS Sensor Activation Tool

- Aids in manual TPMS relearn procedures by triggering and activating sensors for GM, Ford, Chrysler, and many other vehicles

ATEQ



ATQ-VT37-0000 **\$355⁴⁵** VT37 – TPMS Reset/Trigger/Programming Tool

- Activate and display all sensor data
- Make, model, year specific relearn procedures
- Activate, read and service all major OEM & aftermarket sensor brands
- Program over 20 aftermarket sensor brands
- Search TPMS sensor replacement part numbers
- Test vehicle keyfob signal strength/battery status



ATQ-QUICKSET-X **\$380⁸⁵** QUICKSET X – Summer/Winter Tire TPMS Reset Tool

- Easily swap summer and winter tires with a single tool
- Reset TPMS systems in three easy steps
- Includes both OBDII and Manual relearn functionality
- Performs TPMS relearns via the OBD Quick Connector
- Reset the TPMS system after installing new sensors or performing a tire rotation



ATQ-TS56-1002 **\$1396⁵⁵** VT56 All-In-One TPMS & Tire Management Tool

- Select make, model, year via VIN scan
- Comprehensive make, model, year specific relearn procedures
- Triggers/diagnoses 100% of OE sensors
- TPMS reset via OBD2 on more than 80% of car models
- Retrieve/Clear TPMS DTC codes
- Placard adjustment
- Trailer TPMS relearning
- TPMS sensor part number look-up (OE and aftermarket)
- ECU unlocking for Toyota family of vehicles
- Key fob testing
- Tire tread depth functionality (accessory sold separately)



ABS Sensor Testers

HICKOK WAEKON



WAY-20560 **\$538⁶⁵** ABS Sensor Pinpoint Tester

- The quickest way to verify proper wheel speed sensor operation
- Works on all old and new style wheel speed sensors
- Identify sensor shorts or opens
- Visually verify sensor signal output
- Signal simulation enables easy wire harness testing

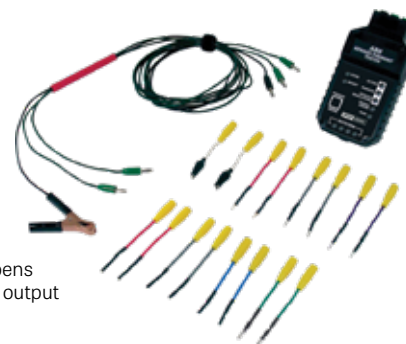

DIAGNOSTIC & TESTING SERVICE TOOLS

Heavy-Duty Truck & Trailer Diagnostics & Testing



Single, Multi-Brand, Global Diagnostic Tool Kit for Commercial, Agriculture, and Off-Highway Vehicles & Material Handling Equipment

- Diagnostic Activations, Components Tests, ECU Data Systems Identification, Systems Configuration, Measuring, Reprogramming & Setting Parameters
- **Jaltest Link Interface:** Rugged diagnostic hardware for Commercial Vehicles
- **Jaltest Diagnosis Software:** Capable of performing manual diagnosis, of measuring values, actuations, visualizing the ECU data, calibrating and resetting electronic systems
- **Jaltest Info:** Technical data software that will allow to check technical data, technical information or wiring diagram belonging to any system
- **Jaltest GRP:** Workshop's management program for the organization and management of the workshop's activity
- **Jaltest ETM:** Dedicated diagnostic software to check EBS electronic modules
- **Jaltest IPARTS:** Spare parts database with cross-references from suppliers and manufacturers
- **Cable set:** From the OBD diagnostic cable to brand specific cables as well as European, Asian and American communication protocols
- **Jaltest Services:** Technical Assistance, Customer Service, Training, E-learning



jaltest
CV
COMMERCIAL VEHICLES

COJ-HDCOMM 
Heavy-Duty Commercial Vehicle Diagnostic Kit



jaltest
OHV
OFF-HIGHWAY VEHICLES

COJ-HDOHW 
Heavy-Duty Off-Highway Vehicle Diagnostic Kit



jaltest
AGV
AGRICULTURAL VEHICLES

COJ-HDAGV 
Heavy-Duty Agricultural Vehicle Diagnostic Kit



jaltest
MHE
MATERIAL HANDLING

COJ-70001049 
Material Handling Equipment Diagnostic Kit

- DPF & SCR regenerations
- Maintenance resets
- Master tilt angle sensor calibration
- Joystick calibrations
- Load cell sensor calibration
- Transmission calibrations



COJ-JDC112A **\$503⁰⁵**
Deutsch PLC Adapter with 9 Pins for Trailers



COJ-JDC40AM2 **\$159³⁵**
PLC Power Supply Adapter Cable for Trailers



COJ-70100003 
Jaltest Rugged PC

- Compact and lightweight with fast connectivity
- Created for vehicle technicians and workshops specialized in internal repairs and maintenance



COJ-70002013 
Jaltest AGV Cable Kit

- Includes: JDC100, JDC505A, JDC506A9, JDC511A, JDC512A, JDC513A, JDC523A



COJ-70001020 
Jaltest Data-Link (VCI) with Bluetooth® Connectivity

- All protocols and norms supported: RP1210, SAE, ISO/OBD II, ISO15765, J2534
- Supports 4 simultaneous CAN channels
- Compatible with most OEM HD software
- **Generic truck diagnostics software for all makes included. No matter the status of your OEM software licenses, you will be able to read and clear fault codes and generate diagnostics reports.**
- Includes: USB cable, Deutsch 6 pin diagnostics cable, Deutsch 9 pin diagnostics cable, OBD diagnostics cable



COJ-70002012 
Jaltest OHV Cable Kit

- Includes: JDC100, JDC201A, JDC203A, JDC216A9, JDC505A, JDC533A, JDC536A

Heavy-Duty Truck & Trailer Diagnostics & Testing



USB-Link™ 3 - Vehicle Communication Interface (VCI)

- Connects to your PC, tablet, or smart phone. The included USB cable gives techs the ability to directly connect to a device when working in the field or during signal interruptions.

Vehicle Network Protocol Support:

- CAN FD / J1939 FD / ISO15765 FD - 250K, 500K, 1M b/s with auto baud detection (3 simultaneous channels)
- Single wire CAN (SWCAN)
- ISO 11898-3 Fault Tolerant CAN (FTCAN)
- Diagnostics Over Internet Protocol (DoIP)
- J1708
- J1850 VPW (Class 2)
- J1850 PWM (SCP)
- ISO 9141 / KWP2000 (ISO 14230) K/L line
- ALDL 9600 and 8192 baud
- ATEC 160 baud

Operating System Compatibility:

- iOS • Android™ • Windows®

Compatible with following softwares:

Detroit Diesel Diagnostic Link; CAT Electronic Technician (On-Highway only); Cummins Insite; International - ServiceMAXX Fleet Pro; Hino eXplorer; Volvo PTT; VCAD Elite Mack/Volvo; V-MAC Service Tools; Allison DOC® For PC-Service Tool - Protocols supported: J1939, J1708/J1587, and J1850; Allison DOC® For Fleets (1000/2000) - Protocols supported: J1939, J1850; Allison DOC® For Fleets (3000/4000) - Protocols supported: J1939, J1708/J1587; Eaton ServiceRanger; Bendix ACom; WABCO Toolbox; Freightliner ServiceLink; International ABS; International DLB; International Intune; International IPC v2.02; PACCAR DAVIE4

Item #	Connection
MPS-121052	Bluetooth® & Wi-Fi
MPS-121054	Wired

MPS-EESM608A

Blue-Link™ 2 - Wireless Mobile Vehicle Communication Interface

- Quick diagnostics for heavy-duty trucks delivered to your mobile device
- Designed to communicate with your iOS or Android device and supporting CAN FD, the Blue-Link™ 2 vehicle interface, combined with the First-Link™ app (get it at the App Store & Google Play), is a critical tool for drivers on the road and service writers at a repair facility

Features:

- Integrated 16-pin and 9-pin Deutsch connectors
- Bluetooth and Wi-Fi communication

Vehicle network protocol support:

- CAN FD / J1939 FD / ISO15765 FD - 250K, 500K, 1M b/s with auto baud detection
- Single wire CAN (SWCAN)
- Fault Tolerant CAN (FTCAN)
- J1708 • ISO 9141 / KWP2000 (ISO 14230) K/L line



First-Link™
Compatible with your own iOS or Android device



Pocket HD™

Capabilities:

- View and clear current and historic faults
- Monitor all vehicle data
- Check engine speed and load, pressures, temperatures, and more
- Display trip data
- Collect and store data from multiple vehicles
- PLC Converter required for trailer brake PLC systems (P/N 604020, available separately)

Software included:

- Light and Medium Truck 2016 - Note: does not include special tests
- Heavy Duty Standard and OBDII Suite - supports J1708 and J1939 communication



Item #	Model
MPS-188080	Pocket HD™
MPS-18808DPF	Pocket HD™ with DPF Regen Software
MPS-917022	DPF Software (Only for Pocket HD™)
MPS-918021	ABS Software (Only for Pocket HD™)

MPS-604120 **\$478⁴⁵**

Universal J560 PLC Adapter

- Interfaces with all WABCO® PLC trailer brakes
- Extends the capability of J1708/J1587 diagnostic tools to support J2497 Power Line Carrier (PLC) communication
- Can be used with a generic ABS diagnostic software application to do the following:
 - Detect ABS warning lamp messages coming from the trailer ECU
 - Test the in-cab trailer ABS warning lamp
 - Test SAE J1708 MID 10 and 11 messages
 - Test SAE J1587 MIDs 136 through 139
- The Universal J560 PLC Adapter can be used with virtually any heavy-duty vehicle communication interface or scan tool



MPS-798021

Pocket HD™ with Complete ABS Kit

- Complete coverage for ABS systems, including Bendix, Meritor WABCO, Wabash National, Eaton, and Haldex PLC

Capabilities:

- Test trailer ABS systems with PLC communications
- Auto-detect the OEM's ECU system configuration
- Read active fault codes
- Read and clear inactive fault codes
- Actuate modulators and valves
- Test the brake retarder relay cycle



MPS-859000-12M

Real-Time Diagnostics on your PC for Commercial Trucks

- eTechnician™ offers extensive coverage for heavy, medium, and light-duty trucks, with real-time diagnostics for every engine, transmission, brake, body, chassis, and more, within your fleet
- Comprehensive coverage, bi-directional support, cloud-based vehicle history reports



DIAGNOSTIC & TESTING SERVICE TOOLS

Heavy-Duty Truck & Trailer Diagnostics & Testing

AUTEL
HEAVY-DUTY



MaxiSYS Commercial Vehicle Diagnostic and Service Tablets

- Tablets equipped with Wi-Fi access

	AUL-MS908CVII	AUL-MS909CV
	Powerful Commercial Vehicle Diagnostics	Advanced Commercial Vehicle Diagnostics
HARDWARE		
J2534 PASS THRU Programming Device	J2534 MaxiFash ELITE with internal Bluetooth VCI	J2534 MaxiFLASH with internal Bluetooth VCI
Connection	Wireless Bluetooth	Wireless Bluetooth
Colour LED Touchscreen	9.7" / 1536 x 2048 DPI	9.7" / 1536 x 2048 DPI
Processor	2.2 GHz + 1.8 GHz Octa-Core	2.2 GHz + 1.8 GHz Octa-Core
Memory	4GB RAM + 128GB SSD	4GB RAM + 128GB SSD
Internal Battery	15,000 mAh	15,000 mAh
Accessory Ports	HDMI / USB	HDMI / USB
OBDII Connectors	DEUTSCH 6 Pin & 9 Pin & Complete Probe Set	DEUTSCH 6 Pin & 9 Pin & Complete Probe Set
Print Data	Wi-Fi to PC	Wi-Fi to PC
SOFTWARE		
Operating System	ANDROID 10.0	ANDROID 10.0
Software Updates (Internet)	1 Year FREE	1 Year FREE
Repair & Test Data	Access All Records	Access All Records
Automatic Detection	Auto-VIN/Auto-SCAN/SCAN VIN	Auto-VIN/Auto-SCAN/SCAN VIN
FEATURES		
Vehicle Diagnostics	Class 3 - Class 9	Class 3 - Class 9
Basic & Special Functions	All Makes & All Models	All Makes & All Models
HD Vehicle Features/Protocols	J1939 / J1708	J1939 / J1708
Service Resets	25 Service Features	25 Service Features
Diesel PM (CLASS 1-9)	Reset Diesel Emissions	Reset Diesel Emissions
System Diagnostics	Access All Modules In All Systems On Select Vehicles	Access All Modules In All Systems On Select Vehicles
Component Activations	Bi-Directional Controls	Bi-Directional Controls
Enhanced Functions	Advanced Coding + Adaptations	Advanced Coding + Adaptations
Battery Analysis		MaxiBAS Software with Multimeter Amp Clamp & B200 Included
ADAS Calibrations		Access Static Calibration Class 3-5* Class 6-8 Dynamic Calibration *ADAS Target Kits Sold Separately

AUTEL

\$229³⁵

AUL-TRAILERPLC

Heavy-Duty J560 PLC Adapter

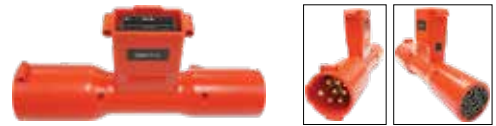

BSD-1699200240 **\$961⁶⁵**

HDS 250 - Heavy-Duty Scan Tool

- Includes HD standard software for Class 4-8 and Global OBD II software for light duty trucks
- "Automatic Protocol Search" - Class 4-8
- HD J1587 / J1708 and J1939 CAN, Engine, Transmission/ABS coverage and more
- Global OBD II quick test
- Works on 24V systems



CDO-HDCODEII **\$463⁶⁵**

Heavy-Duty Truck Code Reader with Extensive Caterpillar Coverage and Generic OBDII

- Covers Class 4-8 HD, medium & light duty truck
- Caterpillar coverage including CAT Truck/Bus, CAT Power Equipment, CAT Construction, CAT Agricultural, CAT Industrial
- Works with all 1996+ OBDII compliant US, European & Asian vehicles
- Access engine, transmission & brakes
- Automatic protocol search • VIN
- **DPF Reset & Regeneration for Fuso, Cummins and Detroit**

CanDo
INTERNATIONAL INC.



IPA-9107B **\$328⁰⁵**

Electric Brake Force Meter with Dynamic Load Simulation and Circuit Testing

- Includes 2023 updates
- Tests vehicle trailer light and electric brake systems
- Simulates trailer brake and light loads
- Works with modern integrated trailer brake controllers; also works with aftermarket brake controllers
- 25 ft. cable allows one-man, in-cab testing
- Use to verify that the vehicle's adaptive (speed/load sensitive) brake-controller output is functioning properly



FUTURE NOW
IPA

Made in
USA

IPA-9007A

Smart MUTT® - Portable Tester for Commercial Trailer Lighting and ABS (7-Way Round Pin)

- Remote-controlled, diagnostic trailer tester that tests lights and most ABS systems on commercial trailers using 7-way round connections
 - Electrical testing (12 Volt operation)
- Includes:
- Remote control, 500mA battery charger and 5 ft. 7-way cable
 - Battery compartment (**battery not included**)



Trailer Testers & Maintenance Tools



Super MUTT® – Commercial Diagnostic Trailer Testers (7 Round Pin)

- Quickly troubleshoot lighting, air brake and ABS systems
- Electrical testing (12/24 Volt operation)
- Remote-controlled



IPA-9008-DL



Pro Edition

- (2) Remote controls
- 5 ft. 7-way cable
- 8 ft. Gladhands
- 10A Smart battery charger
- Face/battery shield & rain cover
- **Battery not included**

IPA-9008-SE



Base Model

- (1) Remote control
- 5 ft. 7-way cable
- Chassis ground cable
- External Battery connector
- 8 ft. Gladhands
- **Battery not included**

Ranger MUTT® – Trailer Testers for Lights and Electric Brakes

- Test the trailer without the truck
- Turn signal simulation and power verification LED
- Internal battery compartment (battery not included)
- Water resistant case
- Input: 12V DC • Output: 10A @ 12V DC
- Short circuit and overload protection



IPA-9101 **\$304⁴⁵**

Light Ranger Mutt® – Utility and RV Type Trailer Tester

- Tests 7-way spade, 6-way round, and 4/5 pin trailer-side harnesses
- Includes:
- 500mA battery charger (battery not included)
- 3-way trailer adapter



IPA-9102 **\$304⁴⁵**

Heavy Ranger MUTT® – Commercial Trailer Tester

- Tests 7-way round pin trailer-side harnesses
- Includes:
- 500mA battery charger (battery not included)



\$23¹⁵

KEN-92000

2-Pc Pigtail Plug Safety Shims™

- Lights stay on and won't flicker during travel
- Prevents ABS lights from coming on because of a poor plug connection

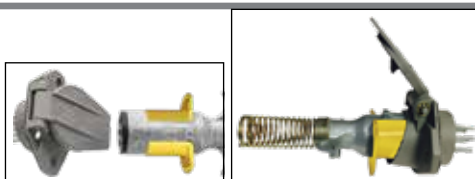

IPA-8000 **\$42⁵⁵**

3-Way Trailer Adapter

- Connect 7-way flat (spade) pin type terminal connections to 6-way round pin and 4/5 pin trailer connections



IPA-TSTPK1 **\$207²⁵**
Multi Trailer Tester Pack

IPA-7865L **\$66⁴⁵**

7-Way Round Pin Tractor Trailer Circuit Tester



IPA-7893 **\$45¹⁵**

7 Flat (Spade) Pin Trailer Circuit Tester



IPA-8025 **\$88¹⁵**

Terminal Connector Cleaners



IPA-8040 **\$73⁰⁵**

3-Pc Diamond-Tip Electrical Terminal Cleaners

- Three different size tips fit and clean most male/female flat pin-type connectors

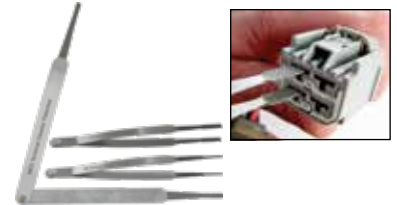

IPA-8042 **\$74³⁵**

12-Pc 5" Long Diamond Micro Round Files

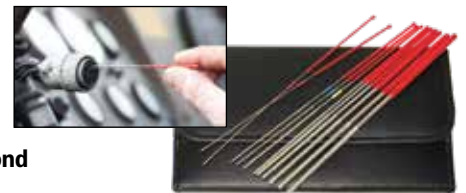

IPA-8048 **\$193⁸⁵**

HD Fleet Electrical Terminal Maintenance Set



Circuit Testers/Volt Testers

POWER PROBE

PWP-PPECT3000 \$281¹⁵
Circuit Tracer & Short Finder – Complete Kit

- Locate short circuits without removing plastic panels, molding, and carpet
- Find open circuits, switches, or breaks in wires
- Test and find intermittent conditions
- Works on cars, boats, RV's, light duty, heavy-duty trucks, and trailers



PWP-ECT3000B \$182⁶⁵
Circuit Tracer & Short Finder – Basic Kit

- Includes ECT3000 Transmitter and ECT3000 Receiver only



Power Probe 4 Electronic Circuit and Component Tester

- Supplies battery voltage and ground
- Continuity & resistance
- Safely test computer circuits
- AC/DC Voltmeter, Ohmmeter
- Min/Max readings
- Frequency (Hz), Pulse width
- AC RMS, Peak to Peak
- Fuel injector tester
- PCM/ECM driver tester
- ECT signal tracer (for use with #PPECT3000, not included)



Item #	Colour	
PWP-PP401AS	Red Unit	\$381.55
PWP-PP405AS	Green Unit	\$381.55

FREE!

Buy #PWP-PPKIT04 and obtain #PWP-PPBC101CS for free: The Basic 12V Circuit Tester.

PWP-PPKIT04 \$618⁰⁵
Power Probe 4 Master Combo Kit

- Power Probe 4
- ECT3000 Transmitter
- ECT3000 Receiver
- Set of leads and adapters
- AAA batteries



POWER PROBE

PWP-PPROKIT01 \$248¹⁵
Power Probe 3 Digital Circuit Tester with #PPDMM Multimeter & Accessories

- Includes leads and adapters



PWP-PPKIT03S \$517⁷⁵
Power Probe 3 Master Combo Kit

- Power Probe 3 Digital Circuit Tester
- ECT3000 Transmitter
- ECT3000 Receiver
- Set of leads and adapters
- AAA batteries



FREE!

Buy #PWP-PPKIT03S and obtain #PWP-PPDMM for free: Automotive Digital Multimeter.

PWP-PP3LS01 \$338²⁵
Power Probe 3 Digital Circuit Tester with Gold Series Test Lead Set

- Same features as Power Probe 3 #PP319 Series
- This kit is completed with the Gold Series Lead Set and adapters to fit, extend, and reach for unsurpassed connectivity



FREE!

Buy #PWP-PP3LS01 and obtain #PWP-PPTACT1CS for free: 12V Volt Tester.

PWP-PPT5VA \$38⁴⁵
Power Probe 5-Volt Adapter

- Connects between your Power Probe and the probe tip
- Compatible with all Power Probes with a banana jack tip (PPBasic, PP3, PP3S, PP3EZ, PP4)



PWP-PPPWM \$64⁴⁵
PWM Adapter (Pulse Width Modulation)

- For 12-24V use
- Control your component
- 10A max continuous output
- Duty cycle adjustable 5% to 100%



PWP-PPAMP \$58⁷⁵
Current Measuring Adapter

- Measures from 1mA to 20A
- Displays Min./Max.



Circuit Testers/Volt Testers

Power Probe 3EZ Ultimate Circuit Tester Kit

- All-in-one tool with DC Voltmeter, MIN, MAX, and Peak to Peak mode
- Determine if motors, lights, fans, relays or circuits are operational on or off the vehicle by applying battery power or ground through the tool
- Test for good/bad grounds
- Test continuity
- EZ learning & EZ diagnostics modes
- 12-24 Volt range
- Larger LCD display
- 2-button navigation menu
- Flip screen mode for upside down use
- Audible & visual indicators



Item #	Colour	
PWP-PP3EZREDAS	Red	\$286.75
PWP-PP3EZGRNAS	Green	\$286.75
PWP-PP3EZCARBAS	Carbon Fiber	\$286.75
PWP-PP3EZCAMOAS	Camouflage	\$286.75



Power Probe 3 Circuit Tester

- Applies power or ground for functional component testing
- DC voltmeter indicators with active feedback
- Voltage & polarity testing
- 12-24 Volt range
- Bad ground indicator
- Continuity tester
- Short circuit indicator
- **Relay and component tester (feature with the kit)**
- **Test trailer lights and connections (feature with the kit)**
- Audible & visual indicators • Cable: 20 ft. (6m)



PP319FTCRED

Item #	Descr.	Colour	
PWP-PP319FTCRED	Kit	Red	\$238.65
PWP-PP319FTCBLK	Kit	Black	\$238.65
PWP-PP319FTCBLU	Kit	Blue	\$238.65
PWP-PP319FTCGRN	Kit	Green	\$238.65
PWP-PP319CARB	Kit	Carb. Fiber	\$238.65
PWP-PP319CAMO	Kit	Camo	\$238.65
PWP-PP319FIRE	Kit	Fire	\$238.65



Item #	Descr.	Colour	
PWP-PP3CSRED	Tester Only	Red	\$186.05
PWP-PP3CSBLK	Tester Only	Black	\$186.05
PWP-PP3CSBLU	Tester Only	Blue	\$186.05
PWP-PP3CSGRN	Tester Only	Green	\$186.05
PWP-PP3CSCARB	Tester Only	Carb. Fiber	\$140.25
PWP-PP3CSCAMO	Tester Only	Camo	\$186.05
PWP-PP3CSFIRE	Tester Only	Fire	\$186.05



PP3CSBLU

PWP-PPBC101CS **\$101⁷⁵**

The Basic 12V Circuit Tester

- Detect positive, negative or open circuits
- Activate electrical components
- Test polarity and continuity
- Activate removed components
- Test trailer lights and connections
- Check fuses and test for short circuits
- Find faulty ground connections instantly
- 4mm banana jack and removable tip
- 20 ft. extendable power lead with the option to connect an additional 20 ft. extension cable



PWP-PPTM01AS **\$448⁵⁵**

The Maestro - Digital Circuit Tester with Multimeter Functions

- Streams live data and waveform patterns which can be mirrored onto your mobile device or most scan tools when paired with the Power Probe Tek App (available for iOS and Android)
- Includes multimeter functions for the daily needs of the automotive technician



PWP-PPTACT1CS **\$57⁶⁵**

12-Volt Test Light with Haptic Feedback

- Vibrates and lights when voltage is over 12 volts
- Functions as a standard test light when a voltage is below 12 volts
- Shows positive voltage, ground, and continuity



PWP-PPTVM01 **\$35⁰⁵**

DC Volt Tester

- Reads 5-35 VDC
- Perfect for testing batteries, lighting systems, trailer connections, and more
- Able to read positive & negative voltage
- 18" (45.7 cm) cable



PWP-PPECB **\$317⁸⁵**

OBD-II Breakout Box

- OBD circuit tester
- Applicable for 12V and 24V systems
- Automatic voltage readings & low voltage alarm
- 16 pin break outs and readings



FREE!

Buy #PWP-PPECB and obtain #PWP-PPTACT1CS for free: 12V Volt Tester.



GTC-CT8002 **\$36⁹⁵**

Professional Cordless Computer-Safe Circuit Tester, 3-28 Volt DC

- Safe to use around automotive computers, electronics, ECM's, sensors and air bags
- No ground or clip required
- Safety V-groove needle accessory for piercing
- Visual, sound and vibration indicators



GTC
General Electronic Tools

MADE IN CANADA

DIAGNOSTIC & TESTING SERVICE TOOLS

Circuit Testers/Volt Testers

ATD-55045 **\$62⁵⁵**

3-48V Digital Circuit Tester

- Large, backlit LCD display for voltage readings
- Checks electrical circuits on all 3-48 Volt vehicle systems
- Impedance rating 200-400 ohms
- 12 ft. coiled test lead



ATD-5624 **\$27³⁵**

6/12 Volts Heavy Duty Circuit Tester

- Cord stretches up to 10 ft.



ATD-55042 **\$46⁴⁵**

12/42 Volts Hybrid Circuit Tester

- Computer and air bag safe
- Automatic voltage identification: **Blue LED** for 12V and **Red LED** for 42V
- Cord stretches up to 12 feet



LIS-28800 **\$149³⁵**

3-30 Volts DC Dual Polarity Digital Test Light with Load Tester

- Works as a regular test light and when you push the button on the tool it applies an 800mA load at 12V DC to easily check for voltage drop on circuits
- 48" cord with heavy-duty alligator clamp for secure connections
- Not computer safe with load applied. Not for use on airbags.



LIS-27430 **\$26³⁵**

24 Volt Heavy-Duty Circuit Tester

- Works on any circuit up to 28 volts including many heavy duty applications on large trucks and farm implements



LIS-32900 **\$38⁰⁵**

Heavy Duty Circuit Tester/Jumper

- A 2-in-1 tester that tests circuits up to 12 volts and works as a jumper wire for power or ground



LIS-32150 **\$30⁴⁵**

Power/Ground Outlet

- Provides a convenient electrical ground and power source from the vehicle



AST-7762 **\$41¹⁵**

Locking Pliers Circuit Tester Light

- A simple test light with locking pliers ground clamp
- Lock onto grounds easier without them easily ripping off
- 12 ft. recoil ground cord
- Wire O.D.: 4mm • Bulb: 12V3W • Amp: 0.45A

AP Astro



AP Astro

AST-7764 **\$51¹⁵**

Digital LCD 3-48V Wide Range Circuit Tester

- Computer safe with back lit LCD display for accurate voltage readouts



AST-7767 **\$43³⁵**

Wide Range Positive and Ground Circuit Tester

- Applications: 6, 12, 24 & 48V DC systems
- 4-60V range, 0.1V resolution
- Small testing current < 10mA
- 10 ft. spring cable
- Display turns green for negative (ground), and red for positive (power)



TOOL AID[®]
PROFESSIONAL AUTOMOTIVE TOOLS

SGT-27000 **\$12⁷⁵**

"Lifetime" 6 & 12 Volt Heavy Duty Circuit Tester

- 5 foot flexible, insulated cord



SGT-27300 **\$21⁶⁵**

6 & 12 Volt Heavy Duty Circuit Tester

- 12 foot retractable wire



SGT-28100 **\$24⁵⁵**

Computer Safe Automotive Logic Probe

- For 6, 12 and 24 volt systems
- Can be used as a standard, single lead circuit tester
- 6 feet of heavy duty, 18 gauge dual leads with large battery clips

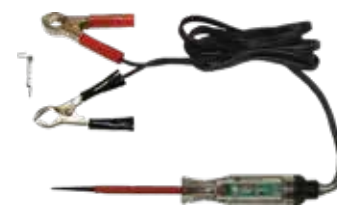

SGT-28200 **\$47¹⁵**

12/24/42 Volt Circuit Tester

- Computer safe
- Wire stretches to 10 feet



SGT-28350 **\$76⁷⁵**

6/12/24/48 Volt Circuit Tester

- Measures from 4 to 60 Volts DC
- 11 foot retractable wire
- Computer safe - draws less than 10 milliamps at 12 volts



Multimeters



Digital Multimeters

	ESI-380	ESI-480A	ESI-385A	ESI-582	ESI-485	ESI-585K	ESI-590	ESI-595	ESI-597IR
	Digital Multimeter	Auto-Ranging Digital Multimeter	Digital Engine Analyzer/Multimeter	Deluxe Multimeter with Amp Shutters	Self-Calibrating Digital Multimeter	Deluxe Multimeter with RPM & Temperature	Professional Digital Multimeter	Professional Multimeter with PC Interface	Premium Multimeter with IR Thermometer
CAT III Safety					CAT III 600V			CAT III 1000V	CAT III 1000V
True RMS Reading					■				
Analog Bargraph + Digital Readings						■		■	■
Auto/Man. Ranging	Manual	Auto	Manual	Manual	Auto	Auto & Manual	Auto	Auto	Auto
DC Volts	Min.: 0-200mV Max.: 1000V	Min.: 0-400mV Max.: 600V	Min.: 0-200mV Max.: 600V	Min.: 0-200mV Max.: 1000V	Min.: 0-60mV Max.: 600V	Min.: 0-320mV Max.: 1000V	Min.: 0-400mV Max.: 1000V	Min.: 0-400mV Max.: 1000V	Min.: 0-400mV Max.: 600V
AC Volts	Min.: 0-200V Max.: 750V	Min.: 0-400mV Max.: 600V		Min.: 0-2V Max.: 700V	Min.: 0-60mV Max.: 600V	Min.: 0-3.2V Max.: 750V	Min.: 0-4V Max.: 700V	Min.: 0-400mV Max.: 750V	Min.: 0-4V Max.: 600V
DC Amps	Min.: 0-200uA Max.: 10A	Min.: 0-400uA Max.: 10A	0-10A	Min.: 0-2mA Max.: 20A	Min.: 0-600uA Max.: 10A	Min.: 0-320uA Max.: 10A	Min.: 0-40uA Max.: 20A	Min.: 0-400uA Max.: 20A	Min.: 0-40mA Max.: 20A
AC Amps		Min.: 0-400uA Max.: 10A		Min.: 0-2mA Max.: 20A	Min.: 0-600uA Max.: 10A	Min.: 0-320uA Max.: 10A	Min.: 0-40uA Max.: 20A	Min.: 0-400uA Max.: 20A	Min.: 0-40mA Max.: 20A
Ohms	0 to 20M	0 to 40M	0 to 20M	0 to 20M	0 to 600M	0 to 32M	0 to 40M	0 to 40M	0 to 40M
Capacitance		0 to 40uF		0 to 200uF	0 to 100mF		0 to 100uf	0 to 100uf	0 to 40mf
Continuity (Audible)	■	■	■	■	■	■	■	■	■
Diode Test	■	■	■	■	■	■	■	■	■
Duty Cycle		■	■		■	■	■	■	■
Dwell			■			■	■	■	■
Frequency		■	■	■	■	■	■	■	■
Input Impedance	10 Meg/Ohm	10 Meg/Ohm	10 Meg/Ohm	10 Meg/Ohm	10 Meg/Ohm	10 Meg/Ohm	10 Meg/Ohm	10 Meg/Ohm	10 Meg/Ohm
Min/Max Function					■			■	■
mS Pulse Width							■	■	■
RPM			■			■	■	■	■
RPM (DIS)						■	■	■	■
Temperature				-4F to 1400F -20C to 760C	-58F to 1292F -50C to 700C	-4F to 1400F -20C to 750C	-4F to 1400F -20C to 760C	-4F to 1400F -20C to 760C	-22F to 1832F -30C to 1000C
Transistor Test	■							■	
PC Interface					■			■	
	\$51.95	\$81.85	\$112.15	\$130.05	\$172.35	\$184.75	\$207.45	\$330.75	\$414.95

DIAGNOSTIC & TESTING SERVICE TOOLS

Multimeters



Digital Multimeters

Model Description	Fluke 107 First-Pass	Fluke 115 True-RMS	Fluke 233/A Kit Remote Display	Fluke 87V Industrial	Fluke 87V-MAX Rugged Industrial	Fluke 87V-MAX/E2 Rugged Industrial	Fluke 88V/A Kit Deluxe Automotive	Fluke 1587 FC Insulation Tester/True-RMS Multimeter
Item #	FLU-4367953	FLU-2538790	FLU-3566508	FLU-2074974	FLU-5140033	FLU-5160712	FLU-2117440	FLU-4691215
BASIC FEATURES								
Counts	6,000	6,000	6,000	20,000	20,000	20,000	20,000	6,000
Auto/Manual Ranging	Auto Ranging	■	■	■	■	■	■	■
True-RMS		AC	AC	AC	AC	AC		AC
MEASUREMENTS								
Voltage AC/DC	600 V	600 V	1,000 V	1,000 V	1,000 V	1,000 V	1,000 V	1,000 V
Current AC/DC	10.0 A	10.0 A	10.0 A	10.0 A	10.0 A	10.0 A	10.0 A	400 mA
Insulation Test Voltages								50 V, 100 V, 250 V, 500 V, 1,000 V
Resistance	40 MΩ	40 MΩ	40 MΩ	50 MΩ	50 MΩ	50 MΩ	50 MΩ	50 MΩ
Frequency	10 to 100 kHz	50 kHz	50 kHz	200 kHz	200 kHz	200 kHz	200 kHz	100 kHz
Capacitance	1,000 μF	10,000 μF	10,000 μF	10,000 μF	10,000 μF	10,000 μF	9,999 μF	9,999 μF
Temperature			-40°C to +400°C	-200°C to +1090°C	-200°C to +1090°C	-200°C to +1090°C	-200°C to +1090°C	-40° C to +537° C
Conductance				60 nS	60 nS	60 nS	60 nS	
Duty Cycle	■		■	■	■	■	■	
Pulse Width							■	
Continuity with Beeper	■	■		■	■	■	■	■
Diode Test	■	■	■	■	■	■	■	■
RPM							■	
Motor Drive Measurement				■	■	■		■
DIAGNOSTICS & DATA								
Min./Max. Recording		■	■	■	■	■	■	■
Relative Reference				■	■	■	■	
Fast Min./Max. 250 μs				250 μs	250 μs	250 μs		
SAFETY								
Input Alert				■	■	■	■	■
CAT III	600 V	600 V	1,000 V	1,000 V	1,000 V	1,000 V	1,000 V	1,000 V
CAT IV			600 V	600 V	600 V	600 V	600 V	600 V
	\$240.45	☎	☎	☎	☎	☎	☎	☎

Multimeters

LANG
TOOLS



- LAN-13803 **\$181⁹⁵**
Automotive Digital Multimeter
- AC & DC Volts
 - AC & DC Amps
 - Resistance, diode, frequency, continuity, temperature
 - Duty cycle and dwell reading
 - RPM measurement
 - Inductive pickup, thermocouple probe, test leads

LANG
TOOLS

LAN-13811 **\$283⁴⁵**

Professional CAT IV Multimeter

- CAT III: 1000V
- CAT IV: 600V
- Current to 10 Amps AC/DC
- Auto ranging
- mS-pulse, duty cycle, resistance, continuity, diode
- Includes test leads and temperature probe



LANG
TOOLS

LAN-13809 **\$67⁰⁵**
CAT III Digital Multimeter

- CAT III 600V safety rating
- 19 functions/7 ranges
- Manual ranging
- DC and AC Voltage to 600V
- 10A DC and AC current
- 2M Ohm resistance
- Basic voltage and resistance measurement
- Audible continuity
- Diode test, Battery test
- Data hold



BOSCH

BSD-F00E9001013CM **\$452¹⁵**
MMD 540H Hybrid Digital Multimeter

- CAT III (1,000V) safety rating for hybrid vehicle circuits
- Peak, Min/Max readings as fast as 1 millisecond
- Higher amperage test ranges, up to 20 Amps
- Inductive RPM clamp for conventional and DIS ignition systems
- Fused diagnostic test leads for safe trouble shooting (up to 20 amps)
- K-Type thermocouple for quick temperature measurement
- Trilingual users manual on CD



PWP-PPDMM **\$209⁸⁵**
Automotive Digital Multimeter

- Hybrid safe CAT-IV 600V
- Digital Volt and Ohmmeter for circuit testing
- AC/DC Voltage to 600V
- Current to 10 Amps
- Resistance/Diode/Continuity to 60M Ohms
- Capacitance: 0.0001µF to 60,000µF
- Frequency, duty cycle
- Temperature: -4°F to 1,832°F (-20°C to 1,000°C)
- Data hold, Min/Max capture, relative measurement

POWER PROBE



PWP-PPDM500MAXCBINT **\$469⁶⁵**

DM500MAX TRMS Industrial Logging Multimeter

- AC/DC voltage: 1000V • AC/DC current: 10A
- CAT III 600V, CAT IV 600V
- 40,000 count, extra-large display
- Auto-save mode, 40,000 records data logging capacity
- Temperature: -200°C-1,200°C (-328°F-2,192°F)
- Low impedance (LoZ), diode, resistance, capacitance, frequency, Min/Max/Avg
- Protective rubber case
- Water, dust, dirt, shock resistant



ATD-5519 **\$129⁹⁵**
Auto Ranging Digital Multimeter

- 43 test ranges, auto-ranging
- Auto power off
- Frequency and Duty Cycle
- Audible continuity beep
- Capacitance and Diode testing
- Dual fuse protection



ATD-5536 **\$78⁹⁵**
Digital Multimeter

- (20) Test ranges • (7) Test functions
- 10 Meg/Ohm input impedance
- 10 Amp range
- Continuity beeper
- Measures: Volts, Ohms, Amps, Diode test, Continuity and Transistor

ATD



ATD-5544 **\$55³⁵**

Economical Digital Mini Multimeter

- (16) Test ranges
- (6) Test functions
- 3-1/2" Digital LCD display
- Measures: Volts, Ohms, Amps, Diode & Battery test



CUR-N2BASE01 **\$427²⁵** **curien**
N2 Neuron - Compact 2-Channel Bluetooth™ Graphing Multimeter

- Connects to iOS, Android or Windows
- Simultaneous dual channel readouts
- Voltage: - AC/DC CAT III 600V
 - Power Calculations
 - Graphing & Waveforms
- Amps: 10 Amp internal fused readings
- Ohms/Precision Volts: Resistance measurements
- Internal thermometer
- 2-Year warranty



DIAGNOSTIC & TESTING SERVICE TOOLS

Current Probes



FLUKE®



Model 365 Detachable Jaw True RMS AC/DC Clamp Meter

- Jaw opening: 0.7" • Max. wire size (MCM): 350
- AC current range (RMS): 200 A • DC current range: 200 A
- AC/DC voltage range: 600 V • Resistance: 6000 Ω
- Continuity • Flashlight / torch
- Auto off • Display hold • Backlight

ESI-683 **\$329³⁵**

High Accuracy Low Current Clamp Meter

- Highly accurate and precise measurements
- Superior zeroing circuit, very low drift or bounce
- Great for parasitic drains
- Auto/manual ranging
- AC/DC test range: 0-600mA, 6.00A, 60.0A
- Sample rate: 2 times per second
- Resolution: 1mA AC/DC
- Accuracy: ±2% of reading
- Large clamp size for ground cables: 16 x 18mm
- Backlit LCD display
- Auto power-off after 15 minutes of non-use
- Power: 9V battery



Current Probes/DMMs

	ESI-697	ESI-698	ESI-684	ESI-695	ESI-685	ESI-655	ESI-687	ESI-688
	400 Amp DC/AC Current Probe	1000 Amp DC/AC High Current Probe	400 Amp DC/AC Auto-Ranging Clamp Meter	80 Amp Low Current Probe for Graphing Meters, Scopes & DMMs	200 Amp Current Probe/Digital Multimeter	1000 Amp Current Probe/Digital Multimeter	80 Amp Low Current Probe/Digital Multimeter	80 Amp Low Current Probe/Digital Multimeter
CAT III Safety			CAT III 600V			CAT III 600V	CAT III 600V	CAT III 600V
True RMS Reading								■
Analog Bargraph + Digital Readings								■
Auto/Man. Ranging			Auto		Auto	Auto	Auto	Auto
DC Volts			Min.: 0-4V Max.: 600V		Min.: 0-400mV Max.: 600V	Min.: 0-400mV Max.: 600V	Min.: 0-400mV Max.: 600V	Min.: 0-500mV Max.: 600V
AC Volts			Min.: 0-4V Max.: 600V		Min.: 0-4V Max.: 600V	Min.: 0-400mV Max.: 600V	Min.: 0-400mV Max.: 600V	Min.: 0-500mV Max.: 600V
DC/AC Amps	Low: 0-40A High: 0-400A	Low: 0-600A High: 0-1000A	Low: 0-40A High: 0-400A	Low: 0-20A High: 0-80A	Low: 0-40A High: 0-200A	Low: 0-40A High: 0-1000A	Low: 0-4A High: 0-80A	Low: 0-5A High: 0-80A
Ohms			■		■	■	■	■
Capacitance			■		■	■	■	■
Continuity (Audible)			■	■	■	■	■	■
Diode Test			■		■	■	■	■
Duty Cycle			■		■	■	■	
Frequency			■		■	■	■	■ (AC only)
Min/Max Function								■
Temperature						-4°F to 1832°F -20°C to 1000°C		-4°F to 1400°F -20°C to 760°C
Clamp Opening	1-1/4"	2-1/8"	1-1/4"	1/2"	7/8"	2-1/8"	1/2"	3/4"
	\$181.85	\$195.15	\$216.95	\$230.75	\$266.55	\$274.75	\$279.15	\$455.55

Fuse/Relay Testing

ESI-191 **\$238⁸⁵**

12V Relay Buddy® Pro Test Kit

- Tests 5 different relay types and also tests shielded relays
- Checks relay coil & switch contacts
- Settable to 4 and 5 pin relay
- Simple Good/Bad relay indication



ESI-194 **\$185⁸⁵**

12V Super Relay Buddy®

- Full 7+ amp load flags intermittently failing relays
- Three test results: Green/Pass, Red/Fail and Yellow/Pass with caution
- Checks 7 different 12 Volt relays
- Automatic 10 cycle test verifies the condition of the relay



ESI-195 **\$287⁴⁵**

12V Super Relay Buddy® Pro Kit

- Settable to 4 and 5 pin relay
- Full 7+ amp load flags intermittently failing relays
- Three test results: Green/Pass, Red/Fail and Yellow/Pass with caution
- Checks 10 different 12 Volt relays
- Automatic 10 cycle test verifies the condition of the relay



ESI-192 **\$121⁶⁵**

12/24V Diagnostic Relay Buddy®

- Tests both 12V and 24V relays
- Checks relay coil & switch contacts
- 3 diagnostic trouble codes help define the cause of the bad relay
- Settable to 4 and 5 pin relay



ESI-193 **\$260²⁵**

12/24V Relay Buddy® Pro Test Kit

- Tests 5 different relays both 12V and 24V
- Checks relay coil & switch contacts
- 3 diagnostic trouble codes help define the cause of the bad relay
- Settable to 4 and 5 pin relay



ESI-316 **\$162⁵⁵**

12/24V Relay Fuse Buddy®

- Acts as a relay bypass switch with live amperage readings during all testing
- Diagnoses if it's a circuit problem or a relay problem
- Displays live circuit current: 20A continuous, 30A momentary
- Gives you on/off control of the circuit power, downstream of the relay
- Includes adapters for 6 different relays



ESI-310 **\$126⁸⁵**

Fuse Buddy™ Pro Test Kit

- Measurement range: 0 to 30 Amps / 48 Volts
- 3 interchangeable test functions:
 - 30 Amp MINI - circuit amperage testing
 - 30 Amp ATC - circuit amperage testing
 - 30 Amp all purpose amperage testing



Fuse Buddy™ Current Loop

- Clamp your current probe over the loop to access the amperage draw through a fused circuit
- Testing range: 0-30 Amps



Item #	Fuse Socket Type	
ESI-307M	Mini Fuse Socket	\$25.35
ESI-308B	ATC Fuse Socket	\$25.35

IPA-8005 **\$147⁶⁵**



Fuse Saver®

- Chase down short circuits without blowing fuses
- 3 resetting, colour-matching thermal breakers: 10 A (red), 15 A (blue) and 20 A (yellow)
- T-type dual fuse adapter on 10 ft. cable for mini and standard spade fuses



IPA-9038A **\$160⁰⁵**

Relay Bypass Switch Kit with Amp Loop

- Control relay circuit independent of "key-on/key-off" systems
- Use in conjunction with clamp-on Amp Probes and Lab Scopes
- Operating range: Up to 20 Amp continuous, 30 Amp surge (12V)
- Covers most makes and models



LIS-60150 **\$130⁶⁵**



Relay Pro® 12-24V Relay Tester

- Tests a wide range of 4 and 5 pin relays
- No need to connect to specific pins, like other testers



LIS-56810 **\$134³⁵**

Relay Test Jumper Kit

- Jumpers fit the most popular size relays on domestic and import vehicles



LIS-60610 **\$134³⁵**

Relay Test Jumper Kit II

- Jumpers fit many popular relays on Honda, Hyundai, Mitsubishi, Nissan, Toyota, newer Ford and GM mini micro relays as well as International trucks



LIS-69300 **\$410⁶⁵**

Master Relay and Fused Circuit Test Kit

- 8 jumpers to fit most popular relays
- #69250 test lead kit and relay puller pliers



DIAGNOSTIC & TESTING SERVICE TOOLS

Terminal Release Tools

LIS-37960 **\$39³⁵**

8" Disconnect Pliers for Locking Push Tab Electrical Connectors

- Easily removes locking push tab style electrical connectors found on mass air flow sensors, fuel injectors, ignition coils and other applications



Lisle

SGT-18580 **\$16³⁵**

Release Tool for Weather Pack Terminals

- Use with three sizes of Weather Pack terminals: 10-12 AWG, 14-16 AWG and 18-22 AWG
- Can also restore the tabs to their original position



TOOL AID[®]
PROFESSIONAL AUTOMOTIVE TOOLS

SGT-18550 **\$73⁷⁵**

Deutsch Terminals Release Tool Kit

- Provides coverage in three wire gage ranges: 14-16, 16-18 & 20-24



SGT-18590 **\$13⁵⁵**

Metri Pack Terminals Release Tool Kit

- Narrow blade for use with 150 & 280 Series terminals
- Wide blade for use with 56, 480, 630 & 800 Series terminals



LIS-59600 **\$44⁷⁵**

Deutsch Terminal Tool

- Works on OEM electrical connectors used on trucks and equipment such as Caterpillar, Kenworth, Peterbilt, Freightliner, Mack & more



Lisle

LIS-14900 **\$26⁶⁵**

Terminal Tool for GM

- For Pack-Con and Weather-Pack terminals on GM C3 Systems



LIS-57750 **\$87⁵⁵**

Wire Terminal Tool Kit

- Works on conventional terminals as well as Pack-Con and Weather-Pack terminals found on many GM vehicles. Blue tool fits many Ford applications.



THEXTON
MANUFACTURING COMPANY

TEX-493 **\$91⁴⁵**

7-Pc Terminal Tool Kit

- Specially designed tips fit the most common automotive connectors



TEX-588 **\$79⁰⁵**

3-Pc Terminal Tool Kit

- 14-16 AWG & size 14 contacts
- 16-18 AWG & size 18 contacts
- 20-24 AWG & size 20 contacts

TEX-508 **\$169⁷⁵**

Deutsch Jumper Wire & Terminal Tool Kit

- Includes jumper wires (2 of each size) for 14, 16, & 20 contact sizes, and 4 terminal release tools



CTA-9812 **\$262⁷⁵**

26-Pc Master Terminal Release Tool Kit Including Deutsch Terminal Tools

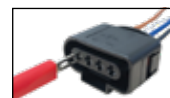

STEELMAN^{PRO}

STE-95839 **\$242⁹⁵**

23-Pc Universal Terminal Tool Kit

- Fit terminals used in BMW, Mercedes, VW, Audi, Jaguar, Porsche, Saab, Skoda, Ford, Renault, Citroen, Chrysler, Fiat, Honda, Mazda, Mitsubishi, Toyota, Seat and Opel



STE-95978 **\$140¹⁵**

19-Pc Master Terminal Tool Kit

- Fit terminals used in Audi, BMW, Chrysler, Ford, GM, Hyundai, Isuzu, Jaguar, Jeep, Kia, Mazda, Mercedes, Mitsubishi, Nissan, Porsche, Saab, Subaru, Volvo, and VW



Back Probes

TOOL AID[®]
PROFESSIONAL AUTOMOTIVE TOOLS

SGT-23500 **\$41⁸⁵**

20-Pc Back Probe Kit

- Steel probes in .027" and .040" diameters
- For testing up to 30 volts
- 12" extension leads



SGT-23550 **\$35⁹⁵**

12-Pc Master Back Probe Kit



SGT-23535 **\$10⁰⁵**

2-Pc Curved Back Probe Set

- For testing up to 25 Volts



SGT-23540 **\$10⁰⁵**

2-Pc Flexible Back Probes

- For testing up to 30 Volts



Back Probes

POWER PROBE

PWP-PPTK0005 **\$18⁰⁵**

Test Probe Adapter Kit

- Blade probe and needle probe



ES

ESI-616 **\$22⁷⁵**

2-Pc Spoon Probe Backprobers

- Curved probes allows back probing of round electrical connectors
- Especially good for weather pack style connectors
- Max. test current: 10 Amps



Lisle

LIS-65150 **\$22⁸⁵**

4-Pc Flexible Back Probes

- Flexible silicone probe bends up to 180°



Lisle

LIS-64750 **\$50⁷⁵**

11-Pc Back Probe & Alligator Clip Set



Lisle

LIS-64900 **\$78⁷⁵**

17-Pc Back Probe & Alligator Clip Set



THEXTON
MANUFACTURING COMPANY

TEX-490 **\$49³⁵**

20-Pc Pin-Type Back Probes Kit

- Sharp, small diameter probes slide along wire into connector to back probe circuit. No need to disconnect connector and terminal.



Test Leads & Adapters

HICKOK WAEKON

WAY-77202 **\$187⁹⁵**

16-Pc Perfect Mate Spade Flex Probe Kit

- Includes male/female probes in X-Small, Small, Medium and Large sizes



LIS-69210 **\$7⁵⁵**

Orange Banana Plug Adapter



Lisle



ESI-146 **\$231³⁵**

54-Pc Automotive Test Connector Kit

- 48" stacking banana plug test leads
- Variety of terminal adapter
- Connects to most automotive vehicle connectors



ESI-147 **\$176⁴⁵**

18-Pc Micro 64 Test Connector Kit

- (4) female & (4) male square Micro64 terminals
- (4) female & (4) male round Micro64 terminals
- (2) 48" stacking banana plug leads



ESI-148 **\$176⁴⁵**

14-Pc Deutsch Test Connector Kit

- Includes sizes 14, 16 and 20 male and female Deutsch connectors and 48" stacking banana plug test leads



ESI-805 **\$48⁷⁵**

6-Pc EZ Test™ Automotive Test Probe Starter Kit

- Standard 4mm banana plug test leads
- Max. test current 10 Amps



ESI-801 **\$314³⁵**

Test Lead Service Center

- Kit includes a variety of test leads and adapters



ESI-846 **\$276⁵⁵**

70-Pc Test & Terminal Set

- (54) Test connectors
- (10) Test leads
- (2) Spoon probe back probes
- (4) Mini back probes/wire piercers

DIAGNOSTIC & TESTING SERVICE TOOLS

Test Leads & Adapters



LOADpro® Test Probes

- Applies a load across circuits on electrical systems
- Performs voltage drop test with the push of a button
- Finds corroded wires/connections, shorts to ground and open circuits

Item #	Description	
ESI-187	24V LOADpro® with 4mm Tip Adapters & Back Probe Kit • 6-24V test range • Includes #180 LOADpro®	\$157.95
ESI-185	48V LOADpro® with Dynamic Test Leads • 12-48V test range	\$119.65

ESI-134 **\$29⁸⁵**

Automotive DMM Test Leads

- ATC fuse holder in-line
- Provides extra overload protection
- Can prevent your DMM's internal fuse from blowing
- For use with any digital multimeter



ESI-629 **\$19⁴⁵**

48" Test Leads with Screw-Off Alligator Clips

- 1,000 Volts max - CATIII
- Maximum 10 Amps



ESI-143 **\$71⁴⁵**

64" Automotive Test Lead Kit

- Test probes
- Flexible silicone back probe pins
- Shielded alligator clips
- Large crocodile clips
- Deluxe storage pouch

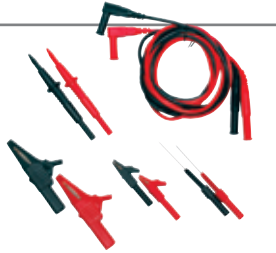

ESI-619 **\$51⁹⁵**

Wire Piercing Clips

- Compatible with most test lead kits
- Pierces wire insulation sized from 22 to 14 AWG



SGT-21200 **\$66⁹⁵**



Clamp Probe Set

- Designed to allow a lone technician to test for voltage drop on top battery posts and many other testing applications
- Its hands-free operation is a useful diagnostic tool when a third hand is needed
- Works with standard 4mm banana plugs
- Probe swivels and adjusts in height to test where you need it
- Works great for testing recessed connections



LANG® Retractable Test Leads

Item #	Leads	Length	Features	
LAN-1135	3	10 ft.	Magnetic, Retractable	\$47.75
LAN-1138	2	30 ft.	Magnetic, Retractable	\$70.45
LAN-1129	3	10 ft.	Retractable	\$27.95
LAN-1130	1	30 ft.	Retractable	\$27.45
LAN-1176	2	15 ft.	7-Pc Retractable Test Leads with Banana Plugs – Includes: test probes, alligator clips, spring hooks	\$102.35

SGT-23150 **\$35⁷⁵**

Perma-Coil® Jumper Leads

- Retractable leads for all purpose circuit jumping and testing
- Stretches to 10 feet



PWP-PPLS01 **\$121⁵⁵**

Gold Series Lead Set

- (2) Auto centering wire piercing probes 28-8 AWG
- Standard 4mm banana plugs and jacks
- Male/male - Female/female conversion adapters
- 1 ft., 3 ft., 6 ft. stackable leads
- (1) Standard probe tip
- 10 gauge, super flexible multi-stranded wire
- Alligator clip



PWP-PPTK003 **\$35⁰⁵**

Piercing Probe Kit

- (1) Yellow 4mm banana jack, 8-18 gauge wires
- (1) Green 4mm banana jack, 20-28 gauge wires



Wire Installation Tools

CTA-1450 **\$39⁷⁵**

6" Long Wire Install Tool Kit

- Use to place and extract cables, connectors and components
- Allows the user to push, pull and feed wires safely and accurately
- Reduce the chance of damage to wire insulation
- Not for high voltage or live wire use



Stethoscopes



LIS-52500 **\$36¹⁵**
Mechanic's Stethoscope
 • Quickly pinpoints the source of mechanical noises in engines, transmissions, differentials and bearings

LIS-52750 **\$45⁰⁵**
Dual Purpose Stethoscope Kit
 • Detects both mechanical and air induced sounds

STEELMAN^{PRO}

STE-60605 **\$778²⁵**
Wireless Rechargeable ChassisEAR[®] 2 Diagnostic Noise Finder

- The ChassisEAR[®] 2 utilizes several advancements and improvements to help quickly pinpoint squeaks, rattles, and any other troublesome and errant noises across a vehicle's engine, axles, and chassis.
- 6 selectable channels on the receiver can be muted individually
- **Includes:** 4 independent wireless transmitters, 4.3" color LCD touchscreen control unit, headphones, 4 microphone clamps, 4 jumper extensions, tie straps, transmitter charging station, AC adapter, USB charging cable, color coded transmitter boots



STEELMAN^{PRO}

STE-65001 **\$156⁹⁵**
EngineEAR[®] Stethoscope
 • Amplifies sound
 • Flexible shaft with metal probe for picking up noise and vibration
 • Pin-points noise and location



STE-06800 **\$212⁵⁵**
EngineEAR[®] II Electronic Diagnostic Stethoscope
 • Quickly pinpoint noises
 • 7 sound settings with adjustability from 60 to 120 decibels
 • Supersensitive microphone with high to low settings
 • Flexible gooseneck shaft for easier access
 • 9V battery included



STE-06600 **\$217⁶⁵**
ChassisEAR[®] Electronic Squeak and Rattle Finder
 • Easily pinpoint noises that cannot be duplicated in a repair stall and only occur during road driving
 • Connect up to (6) microphones to different under-chassis locations
 • 16-foot long colour coded wire leads allow microphones to be positioned in difficult to reach places



STE-61082 **\$550²⁵**
Wireless ChassisEAR[®] Diagnostic Device Kit

- Specifically designed to pinpoint squeaks, rattles, and any other troublesome and errant noises across a vehicle's engine, axles, and chassis
- Ideal for diagnosing faulty fuel injectors, bearings, gears, suspensions, transmissions, differentials and CV joints, and under hoods
- 4 independent transmitters for monitoring multiple locations
- 50-foot signal range



Combustible Gas Leak Detectors

KLE-ET120 **\$244¹⁵**
Combustible Gas Leak Detector

- Two levels of sensitivity: High (50 to 1000 ppm) and Low (50 to 10,000 ppm)
- Measures methane, propane, butane, and other gases to detect for leaks
- Visual and audible alerts
- Automatic zero-point calibration at power-up
- 18" flexible cable • Auto power-off
- Includes carrying pouch and (4) AAA batteries



MTC-55975 **\$340⁹⁵**
Intella Sense III Combustible Gas Leak Detector

- Response time: less than 1 second
- Intelligent tip eliminates potential of false alarms
- High, Medium and Low sensitivity
- Sensor life: 2,000 hours



Leak & Defect Detector

TRACERLINE[®] Marksman II



HBF-TP-9367L **\$1010³⁵**
Ultrasonic Diagnostic Tool

- Converts & amplifies inaudible ultrasonic sounds into audible "natural" sounds
- **Applications:** Automotive, HD Trucks, A/C, Refrigeration
- Pinpoints quickly and effortlessly air brake leaks, gear and bearing wear in wheel hubs, transmissions, transfer cases, differentials, compressed air, vacuum, electric motors and other pressurized leaks
- 5-LED signal intensity indicator and audible alarm
- **Laser pointer** to help pinpoint the source of pressurized leaks
- Checked for electrical discharge associated with insulation breakdown, carbon tracking and arcing
- Unique ultrasonic emitter helps locate faulty seals, gaskets and weather stripping in passenger cabs, trailers and other non-pressurized enclosures



Leak Detection Smoke Machines



RDL-95-0400



ReadySmoke™ – Diagnostic Leak Detection Smoke Machine

- Finds leaks fast and is simple to operate
- Nitrogen compatible
- Kit comes with everything you need, including:
 - 2 oz OEM-approved vapor producing fluid that lasts hundreds of tests
 - Halogen inspection light
- Compact size measures only 6" W x 7" H



Made in USA

RDL-95-0003C



Smoke Pro® Total Tech™ – Diagnostic Leak Detection Smoke Machine

- A professional grade tool that uses pressure, vacuum, and visual vapor to quickly diagnose trouble codes, pinpoint EVAP leaks, cooling system leaks, intake and exhaust leaks, and wind and water intrusion
- Now comes with Easy INTAKE™



RDL-96-0190

\$171³⁵

EasyConnect® Smoke Machine EVAP Adapter Set

- EasyConnect® is compatible with any smoke machine and provides a fast and easy way to hook up the smoke machine to late model vehicles that no longer have an EVAP test port
- Kit includes 4 different sized adapters with 4 add-on components to connect the smoke machine to most late model automobiles and light-duty trucks



MVC-500-0150



MOTORVAC

Cool Smoke® HP Leak Detection System

- For turbo gasoline and diesel leak detection
- Works with Android® or Apple® mobile devices
- Operating range of 3-60 psi • 3.5" digital LCD display
- Multiple languages and units of measure
- Operates on 12 or 24 Volt DC
- Factory-filled with Cool Smoke® Fluid
- Comes with the Cool Smoke® HP Turbo Adapter Kit (#200-0150) which includes plugs, hoses, clamps, lights and glasses



MVC-500-0100

\$1518⁴⁵

MOTORVAC

MotorVac® CoolSmoke EVAP Leak Detection System

- Uses 12 Volt DC
- Pressure and vacuum leak diagnostics with instant smoke vapor with UV enhanced dye
- Dual mode leak detection: test for leaks with or without smoke
- Includes: 120 ml bottle of CoolSmoke UV FLUID (#400-1055), accessory kit, powerful 50W light to easily locate leaks



MOTORVAC

MVC-400-1054

\$63⁷⁵

MotorVac® Cool Smoke Fluid with UV Dye

- Designed specifically for use with the MotorVac® Cool Smoke System
- 200 ml refill



Mastercool®
"World Class Quality"

12V DC Diagnostic Smoke Machines

- Specifically engineered units for EVAP, turbo/intake and heavy-duty truck testing
 - Quickly generates non-toxic and non-corrosive smoke
- Units include:
- A complete accessory kit for a wide range of diagnostic leak testing
 - High intensity smoke illuminating flashlight
 - 8 oz smoke producing fluid
 - 10 ft. 12V power cables with durable clamps
 - Heavy-duty 10 ft. smoke injection hose

MTC-43060-EV **\$1195⁰⁵**

EVAP Diagnostic Smoke Machine

- **Applications:** For all EVAP, intake, exhaust system, vacuum lines and vacuum components, passenger compartment window and sunroof, headlight/tail-light fixtures and much more
- **Smoke injection options:**
 - Built-in internal compressor, shop air, and inert gases
- Built-in pressure regulated at 0.5 PSI for safe evap testing
- Large pressure decay gauge: 0-30 in. H₂O (70 mbar)



MTC-43060-TB **\$1493⁸⁵**

TURBO/INTAKE Diagnostic Smoke Machine

- **Applications:** For all turbo, intakes, exhaust, vacuum lines and vacuum components, manifolds, passenger compartment window and sunroof, headlight/tail-light fixtures and much more. Not for EVAP testing.
- **Smoke injection options:**
 - Built-in internal compressor, shop air, and inert gases
- Pressure can be regulated from 0 to 28 PSI
- Large pressure decay gauge: 0-30 PSI
- Available accessories: #43060-DW-ST: Diffuser Assembly - Short



MTC-43060-HD **\$1908²⁵**

HEAVY-DUTY TRUCK Diagnostic Smoke Machine

- **Applications:** For all HD truck intakes, stack exhaust, vacuum lines and components, cabin air and water leaks and much more. Not for EVAP testing.
- **Smoke injection options:** Shop air or inert gas
- Pressure can be regulated from 0 to 28 PSI
- Large pressure decay gauge: 0-30 PSI
- Available accessories: #43060-DW-LG: Diffuser Assembly - Long
#43060-HDBR-9: 9" Bladder Ring
#43060-HDLB: Large Bladder for HD Truck



Noid Light Testers

SGT-36300 **\$39³⁵**  **PROFESSIONAL AUTOMOTIVE TOOLS**

Noid Light Set

- Tests electronic fuel injection signals
- Checks GM TBI, Bosch PFI, Ford TBI, GM PFI, Geo TBI and GM SCPI



Spark/EFI/IAC Testers

 **PROFESSIONAL AUTOMOTIVE TOOLS**

SGT-36350 **\$125⁹⁵**

Combination Test Kit with In-Line Spark Checker for Recessed Plugs, Noid Lights and IAC Test Lights

- Use to test spark plug circuits, electronic fuel injection signals and idle air control (IAC) circuits



Refractometers





ATD-3705 **\$129²⁵**

Coolant/Battery Refractometer

- Works with Ethylene or Propylene Glycol or long-life anti-freeze
- Measures battery acid gravity to determine battery life

ATD-3325 **\$168⁶⁵**

Coolant/DEF/Battery Refractometer

- Automatic temperature compensation
- Reads both Ethylene and Propylene Glycol based coolants







CEN-3R401 **\$151⁴⁵**

Coolant/DEF/Battery Refractometer

- Easily check status of Coolant, DEF and Battery Fluid





MUK-727 090 **\$186²⁵**

DEF/AD-BLUE 4-in-1 Refractometer

- Tests the quality of:
- Ad-Blue • Radiator coolant
 - Windshield washer fluid • Battery acid

OTC-5025 **\$196⁰⁵**

DEF Refractometer

- For most Class 7-8 trucks that utilize SCR
- Simple and quick process to get an accurate measurement of UREA concentration in DEF or AdBlue solution



Tachometers



ESI-328 **\$101⁶⁵**

EZ Tach + PLUS Automotive Tachometer

- Picks up RPM signal wirelessly or with supplied inductive pickup
- Measures RPM on a wide variety of engines, from 0 to 20,000 RPM
- Great for setting idle speeds



ESI-329 **\$56⁷⁵**

Small Engine Tach/Hour Meter

- RPM in real time: 0-20,000 RPM
- Max RPM: recordable, viewable and resettable

Hour meter and engine/job timer:

- Hours: 0-99,999 hours
- JOB hours: 0-99,999 hours
- SVC (Service Interval) hours: 0-200 hours



ESI-332 **\$155⁴⁵**

Professional Laser Tachometer

- For easy and accurate measurement of RPM
- Detects RPM from up to 6 feet away
- Test range: 0-99,999 RPM
- Memory: Min/Max



ESI-333 **\$194⁸⁵**

Professional Laser/Contact Tachometer

- Dual function laser photo and contact tachometer with 12 different measurement types. Laser detects RPM up to 6 feet away. Contact function adds distance and frequency measuring to the unit's capability.
- Test range: 0-99,999 RPM
- Memory: Min/Max/Avg (stores 10 records)



Timing Lights



ESI-125 **\$161⁹⁵**

Digital Tach/Advance Timing Light

- Indicates Tach (RPM) and Degrees Advance
- Measures ignition spark advance from 0-90°
- 2 & 4 stroke tachometer measures engine speed up to 9,999 RPM
- Works with 12 Volt electrical systems



Inspection Cameras/Videoscopes

Milwaukee



MLW-2319-20 **\$147⁹⁵**

M-Spector™ Digital Inspection Camera

- Ideal for drain line and behind wall inspections
- 4.3" LCD screen
- 4 ft. cable
- 10mm camera head
- Optimized 720p camera
- 5-mode brightness adjustment
- 180° digital image rotation
- Includes: mirror and plumbing ball attachments, and (4) AA batteries



MLW-2316-21 **\$775⁴⁵**

M-Spector Flex™ Digital Inspection Camera with Wireless Screen

- 3.5" wireless LCD display console
- 9 ft. cable
- 15X greater LED brightness
- 12.5mm 640x480 camera head
- Digitally rotate and zoom images
- Capture images or video with audio
- (1) USB Cable
- (1) SD Card
- (1) 12V CP1.5 battery pack
- (1) 12V battery charger



AUTEL

MaxiVideo 8.5mm Head Rechargeable HD Inspection Videoscopes

- 7x digital zoom
- 1m waterproof cable
- 10-level adjustable LED light
- Wider, 70° field of view
- Record & playback images or videos
- On-screen horiz./vert. reverse
- Compatible with 5.5mm single camera head
- 8G micro-SD card, charger, USB cable



MV480



MV460



AUL-MV480 **\$426⁰⁵**

4.1" LCD Display MaxiVideo

- Front and side view camera
- Magnet, mirror & hook attachments

AUL-MV460 **\$325¹⁵**

3.5" LCD Display MaxiVideo

- Front view camera
- Magnet & mirror attachments

Cal-Van Tools

CAL-84 **\$170⁷⁵**

Wi-Fi Borescope

- High resolution, multiple aspect camera (1920x1080, 1280x720, and 640x480) with adjustable LED lighting
- 6mm camera, 58" cable
- Independent WiFi signal
- Mobile app for image capture, video recording and album storage
- Lens and cable are dust and waterproof (up to 3 ft. for 30 min.)



Cal-Van Tools

CAL-86 **\$254⁶⁵**

Dual View Wi-Fi Borescope

- Front and side video and image capture
- 6mm camera, 58" cable
- Max. zoom: 3X
- 1080HD camera
- 7 ultra-bright adjustable LEDs
- Independent WiFi signal
- Camera, lens and cable are IP-67 rated water-resistant
- Rechargeable battery



Cal-Van Tools

CAL-85 **\$211¹⁵**

Pistol Grip Wi-Fi Borescope

- Turns a smartphone into a high resolution borescope
- Connectivity: internal Wi-Fi
- 5.5mm camera, 30" cable
- Max. zoom: 3X
- Resolution: 1280 x 720 px
- 6 ultra-bright adjustable LEDs
- Camera, lens and cable are IP-67 rated water-resistant
- Rechargeable battery



Smartphone not included

Inspection Mirrors / Pick-Up Tools / Magnifiers



ULL-E-DM-1 **\$216⁷⁵** Rechargeable Digital Inspection Mirror

- Smart phone enabled 720P camera with LED illumination
- View and save photos & videos to your smartphone by using the Ullman DM App - available in Android and IOS app stores
- Dual point 360° rotational knuckle
- Telescopes from 15.5" to 51.25"



Telescoping LED Lighted Inspection Mirrors

- Flexible head
- Batteries included

Item #	Mirror	Length	
ULL-HTC-2LT	2-3/8" diameter	10" to 37"	\$35.85
ULL-HTK-2LT	2-1/4" x 3-1/2"	11" to 30"	\$38.15

Telescoping Acrylic Inspection Mirrors



Item #	Mirror	Length	
MAY-17750	2-1/4" x 3.6"	7-3/4" - 35-1/2"	\$33.55
MAY-17755	1-3/4" x 2-1/2"	6-1/2" - 27-1/2"	\$22.85

MAY-17720 **\$98²⁵** 5-Pc Inspection & Pick-Up Tool Kit

- Magnifier
- S/S shaft: 7-1/2"
- Mirror: 2-3/4" x 1-3/4"
- 14 lb and 3 lb magnets



MAY-17730 **\$141²⁵** 7-Pc Inspection & Pick-Up Tool Kit

- Magnifier
- Flexible shaft: 21-3/4"
- S/S shaft: 7-1/2"
- Mirrors: 2-3/4" x 1-3/4" and 2-1/2" x 3/4"
- 14 lb and 3 lb magnets



Telescoping Magnetic Pick-Up Tools



Item #	Head	Magnet	Length	
MAY-17830	Swivel	14 lbs	7-1/4" - 33"	\$47.45
MAY-17810	Fixed	14 lbs	7-1/2" - 32"	\$38.65
MAY-17845	Fixed	3 lbs	7-1/2" - 32"	\$30.55



Telescoping Magnetic Pick-Up Tools

Item #	Magnet	Extension	
MAY-17960	2-1/2 lbs	6-1/4" to 34-1/4"	\$15.85
MAY-17961	5 lbs	6-1/4" to 34-1/4"	\$19.15
MAY-17962	10 lbs	6-1/4" to 30-1/4"	\$23.55

ULL-E-CART-1 **\$262²⁵** CART™ Camera Assisted Magnetic Retrieval Tool

- Retractable, sturdy, four-pronged pick-up claw
- (4) LED lights with six brightness levels
- 4 lb capacity magnet
- 32" long flexible arm
- (4) AA batteries included



MUK-702 503 **\$121⁸⁵** 3-Pc 16" Long Flexible Magnetic Pick-Up Tool Set

- Capacity: 1/2 lb, 1 lb, 4 lb



MUK-702 270 **\$19⁹⁵** 16" Long Flexible Magnetic Pick-Up Tool

- 1/2 lb capacity

SUN-9813 **\$69⁴⁵** 3-Piece Pick-Up Tool Set

- 24" long flexible shafts
- 1/4" bit driver and 1/4" socket driver
- Pick-up tool can be used as a claw or magnet



TIT-32913 **\$7¹⁵** Backscratcher Magnetic Pick-Up Tool

- Extends 8-1/4" to 27"



TIT-11161 **\$4⁹⁵** 3 Lb. Telescoping Magnetic Pick-Up Tool

- Extends to 25"



GWR-2593 **\$10¹⁵** Telescoping Magnetic Pick-Up Tool

- Extends up to 25-9/16"
- Capacity: 1-1/2 lbs



TIT-15029 **\$17¹⁵** Magnifying Glass with LED Light

- 4.4x magnification
- 2-7/8" lens
- 7-1/4" overall length
- Non-distorting optical grade glass lens
- Rubber grip handle and rubber framing



12V Impact Wrenches



M12 FUEL™ Impact Wrenches (Bare Tool)

Item #	Drive	Max. Torque	RPM	Drive Control	
MLW-2552-20	1/4" Stubby	100 ft-lb	3,200	4-mode	\$197.95
MLW-2454-20	3/8"	117 ft-lb (1,400 in-lb)	2,650	2-mode	\$197.95
MLW-2554-20	3/8" Stubby	250 ft-lb	2,700	4-mode	\$218.05
MLW-2555-20	1/2" Stubby	250 ft-lb	2,700	4-mode	\$218.55

FREE!

Buy #MLW-2554-20 or #MLW-2555-20 and obtain #MLW-48-11-2430 for free: M12™ 12V CP3.0 Battery, 3Ah.

MLW-49-16-2554 **\$33²⁵**
Protective Boot for M12™ FUEL™ Stubby Impact Wrench
 • Fits Models #2554, #2555 and #2555P



MLW-2463-20 **\$127⁹⁵**
M12™ 3/8" Drive Impact Wrench (Bare Tool)
 • 100 ft-lb/1,200 in-lb
 • 0-2,500 RPM
 • 0-3,300 IPM
 • Clutch settings: 15+1
 • Trigger lock



M12™ Stubby Impact Wrench Kits
 • 4-Mode drive control
 • (1) M12™ CP2.0 battery
 • (1) M12™ XC4.0 battery
 • (1) Charger



Item #	Drive	Max. Torque	RPM	
MLW-2554-22	3/8"	250 ft-lb	2,700	\$354.25
MLW-2555-22	1/2"	250 ft-lb	2,700	\$354.25

M12 FUEL™ Low Profile Right Angle Impact Wrenches with Friction Ring Anvil (Bare Tools)

- Low profile head of 2.8"
- 4-Mode drive control



Item #	Drive	Max. Torque	RPM	
MLW-2564-20	3/8"	220 ft-lb	0 - 3,000	\$233.95
MLW-2565-20	1/2"	220 ft-lb	0 - 3,000	\$233.95

49-16-2564



M12 FUEL™ Low Profile Right Angle Impact Wrenches with Friction Ring

- Low profile head of 2.8"
- 4-Mode drive control
- (2) M12™ CP2.0 batteries
- (1) Charger



Item #	Drive	Max. Torque	RPM	
MLW-2564-22	3/8"	220 ft-lb	0 - 3,000	\$397.95
MLW-2565-22	1/2"	220 ft-lb	0 - 3,000	\$397.95
MLW-49-16-2564	M12™ Right Angle Impact Wrench Protective Boot			\$33.85

DEWALT

XTREME 12V MAX* Brushless Compact Impact Wrench Kits

- Loosening torque: 400 ft-lbs
- Fastening torque: 250 ft-lbs
- 2,850 RPM
- (2) 12V batteries: 3Ah and 5Ah
- (1) Charger



DCF901GJ1G1
DCF903GJ1G1

Item #	Drive	
DEW-DCF903GJ1G1	3/8"	\$664.85
DEW-DCF901GJ1G1	1/2"	\$601.55

XTREME 12V MAX* Brushless Compact Impact Wrenches (Bare Tool)

- Loosening torque: 400 ft-lbs
- Fastening torque: 250 ft-lbs
- 2,850 RPM

DEWALT



Item #	Drive	
DEW-DCF903B	3/8"	\$217.25
DEW-DCF901B	1/2"	\$217.25

DCF901B
DCF903B

18V Impact Wrenches



M18 FUEL™ 18V Impact Wrenches with Friction Ring (Bare Tool)

- 4-mode drive control

Item #	Drive	Loosen. Torque	Fastening Torque	RPM	
MLW-2854-20	3/8"		250 ft-lb	0-2,400	\$297.95
MLW-2960-20	3/8"	600 ft-lb	550 ft-lb	0-2,575	\$320.35
MLW-2855-20	1/2"		250 ft-lb	0-2,400	\$239.45
MLW-2962-20	1/2"	650 ft-lb	550 ft-lb	0-1,250/0-1,950/0-2,575/0-2,575	\$348.95
MLW-2863-20	1/2"	1,400 ft-lb	1,000 ft-lb	0-1,750	\$397.95
MLW-2967-20	1/2"	Up to 1,600 ft-lb with XC6.0	Up to 1,200 ft-lb with XC6.0	0-2,000 4-mode drive control	\$388.95
MLW-2864-20	3/4"	1,500 ft-lb	1,200 ft-lb	0-1,800	\$488.95
MLW-2867-20	1"	1,800 ft-lb	1,500 ft-lb	0-1,800	\$1048.95
MLW-49-16-2767	High Torque Impact Wrench Boot for Models #2767 and #2863				\$49.45

FREE!
While quantities last
February 1-March 30 Promotion.

Buy #MLW-2864-20 and obtain for free #MLW-48-11-1865: 18V XP6.0 Battery.

MLW-2967-22 **\$636²⁵** M18™ 1/2" High Torque Impact Wrench with Friction Ring Kit

- Loosening torque: 1,500 ft-lb
- Max. torque: 1,100 ft-lb
- 4-mode drive control
- 0-2,000 RPM
- (2) M18™ XC5.0 Resistant batteries (48-11-1850R)
- (1) 18V/12V multi-voltage charger



MLW-2767-22GR **\$913²⁵** M18™ 1/2" Drive Impact Wrench & Grease Gun Kit

- Loosening torque: 1,400 ft-lb
- Max. torque: 1,000 ft-lb
- 0-1,750 RPM
- (2) M18™ XC5.0 Resistant batteries (48-11-1850R)
- (1) M18™/M12™ multi-voltage charger



M18™ with ONE-KEY™ High Torque Impact Wrench Kits with Friction Ring

- 4-mode drive control
- (2) M18™ XC5.0 Resistant batteries (48-11-1850R)
- (1) 18V/12V multi-voltage charger



Item #	Drive	Loosen. Torque	Fastening Torque	RPM	
MLW-2863-22R	1/2"	1,400 ft-lb	1,000 ft-lb	0-1,750	\$697.95
MLW-2864-22R	3/4"	1,500 ft-lb	1,200 ft-lb	0-1,800	\$652.65

MLW-2854-22R **\$518⁹⁵** M18™ 3/8" Drive Compact Impact Wrench with Friction Ring

- Max. torque: 250 ft-lb
- 0-3,500 RPM
- 4-mode drive control
- (2) M18™ 18V XC5.0 Resistant batteries
- (1) 18V/12V multi-voltage charger



MLW-3010-22 **\$1017⁹⁵** M18™ High Torque & Mid-Torque Impact Wrench Combo Kit

- **1/2" High Torque (#2967-20):**
- 1,600 ft-lb/1,200 ft-lb
- 0-2,000 RPM
- **3/8" Mid-Torque (#2960-20):**
- 600 ft-lb/550 ft-lb
- 0-2,575 RPM
- (2) M18™ 18V XC5.0 Resistant batteries
- (1) 18V/12V multi-voltage charger



MLW-2962-22R **\$607²⁵** M18™ 1/2" Drive Mid-Torque Impact Wrench

- Loosening torque: 650 ft-lb
- Fastening torque: 550 ft-lb
- 0-2,575 RPM
- 4-mode drive control
- (2) M18™ 18V XC5.0 Resistant batteries
- (1) 18V/12V multi-voltage charger



MLW-2867-22 **\$1327⁴⁵** M18™ 1" Drive High Torque Impact Wrench with ONE-KEY™

- Loosening torque: 1,800 ft-lb
- Fastening torque: 1,500 ft-lb
- 0-1,650 RPM • 4-mode drive control
- (2) 18V XC8.0 batteries
- (1) Rapid charger



M18 FUEL™ 1" Drive D-Handle High Torque Impact Wrenches with ONE-KEY™

- Loosening torque: 2,000 ft-lb
- Fastening torque: 1,900 ft-lb • 0-1,500 RPM



Item #	Anvil	Description	
MLW-2868-22HD	1"	Kit with (2) 18V HD12.0 Batteries & (1) 18V/12V Multi-Voltage Rapid Charger	\$1607.75
MLW-2868-20	1"	Bare Tool	\$1248.95
MLW-2869-22HD	6"	Kit with (2) 18V HD12.0 Batteries & (1) 18V/12V Multi-Voltage Rapid Charger	\$1798.95
MLW-2869-20	6"	Bare Tool	\$1248.95

20V Impact Wrenches



20V MAX* Li-Ion Impact Wrenches (Bare Tools)

Item #	Features	Dr.	Loosen. Torque	Max. Torque	RPM	Price
DEW-DCF923B	• Compact • Hog Ring Anvil • 4-Mode	3/8"	450 ft-lb	300 ft-lb	0-2,500	\$228.85
DEW-DCF922B	• Compact • Detent Pin Anvil • 4-Mode	1/2"	450 ft-lb	300 ft-lb	0-2,500	\$228.85
DEW-DCF891B	• Hog Ring Anvil • 4-Mode	1/2"	800 ft-lb	600 ft-lb	0-2,000	\$345.75
DEW-DCF900B	• Hog Ring Anvil • 4-Mode	1/2"	1,400 ft-lb	1,030 ft-lb	0-2,300	\$366.85
DEW-DCF897B	• Brushless • Hog Ring Anvil • 3-Mode	3/4"	1,200 ft-lb	700 ft-lb	0-400 1,200 1,900	\$438.05

DEW-DCF923P2 **\$523⁵⁵** Atomic 20V MAX* 3/8" Drive Cordless Impact Wrench with Hog Ring Anvil Kit

- Loosening torque: 450 ft-lb
- Max. torque: 300 ft-lb
- 0-2,500 RPM • 0-3,550 IPM
- (2) 20V Li-Ion batteries, 5.0Ah
- (1) Charger



\$466⁷⁵ DEW-DCF911P2 20V MAX* XR® 1/2" Drive Compact Impact Wrench Kit

- Loosening torque: 400 ft-lb
- Max. torque: 250 ft-lb
- 2,850 RPM • 3,250 IPM
- (2) 20V Li-Ion batteries, 5.0Ah
- (1) Charger



DEW-DCF891P2 **\$564²⁵** 20V MAX* XR® 1/2" Drive Mid-Range Impact Wrench with Hog Ring Anvil Kit

- Loosening torque: 800 ft-lb
- Max. torque: 600 ft-lb
- 0-2,000 RPM • 0-3,250 IPM
- 4 speed settings
- (2) 20V MAX* 5.0 Ah batteries
- (1) Charger



20V MAX* XR® 1/2" Drive High Torque Impact Wrench with Hog Ring Anvil Kits

- Loosening torque: 1,400 ft-lb
- Max. torque: 1,030 ft-lb
- 0-2,300 RPM
- 0-2,200 IPM
- 4 speed settings



Item #	20V MAX* 5.0 Ah Batteries	12V/20V MAX* Charger	Price
DEW-DCF900P1	1	1	\$530.15
DEW-DCF900P2	2	1	\$643.95



IRC-W3131-K22 **\$598²⁵** IQV20 20V 3/8" Drive Compact Impact Wrench Kit

- Loosening: up to 400 ft-lb
- Fastening: up to 300 ft-lb
- 0-2,800 RPM
- Three speed modes
- 360° LED light ring
- (1) 5.6 Ah battery and (1) 2.5 Ah battery
- (1) Charger



FREE!



Buy your choice of #IRC-W9691, #IRC-W9491-K4E, or #IRC-W9491 and obtain a \$50 Esso Gift Card for free.

FREE!

While quantities last



Buy #IRC-W9691-K4E and obtain #IRC-2145QIMAX for free: 3/4" Drive Quiet Air Impact Wrench.



IQV²⁰ 20V Li-Ion 1" Drive Impact Wrenches

- Loosening torque: 3,000 ft-lb
- Max. torque: 2,200 ft-lb
- 890 RPM
- 3 Power modes: MAX, MID, Snug
- Weight: 29.1 lbs
- Kits come with: (4) 20V BL2022 Li-Ion batteries and (1) dual bay charger
- 3-Year warranty



Item #	Anvil	Description
IRC-W9691-K4E	6"	Kit with (4) 20V Batteries & (1) Dual Bay Charger
IRC-W9691	6"	Bare Tool
IRC-W9491-K4E	1"	Kit with (4) 20V Batteries & (1) Dual Bay Charger
IRC-W9491	1"	Bare Tool

Cordless Multi-Tool Kits

\$669³⁵

DEW-DCK447P2

20V MAX* XR Premium Brushless Compact Drill/Driver Combo Kit (4-Tool)

- 1/2" Drill/Driver (#DCD800B):
 - 0-650/0-2,000 RPM
 - Pivoting, 3-mode LED
- 1/4" 3-Speed Impact Driver (#DCF887B):
 - 0-1,000/2,800/3,250 RPM
- 7-1/4" Circular Saw (#DCS570B):
 - 5,500 RPM
 - 900W
 - Cutting capacity: 2-9/16" at 90°
 - Bevel capacity: up to 57°
- 160 Lumens LED Work Light (#DCL040)
- (2) 20V 5.0Ah batteries
- (1) Charger



\$638⁰⁵

DEW-DCK449P2

20V MAX* XR Premium Brushless Compact Hammer Drill Combo Kit (4-Tool)

- 1/2" Hammer Drill (#DCD805B):
 - 0-650/0-2,000 RPM
 - Pivoting, 3-mode LED
- 1/4" 3-Speed Impact Driver (#DCF887B):
 - 0-1,000/2,800/3,250 RPM
- Reciprocating Saw (#DCS382B):
 - Stroke length: 1-1/8"
 - 0 - 3200 SPM
- 160 Lumens LED Work Light (#DCL040)
- (2) 20V 5.0Ah batteries • (1) Charger



\$549⁵⁵

MLW-2991-22

M18 FUEL™ Compact Impact Wrench & Grinder Combo Kit

- 3/8" Compact Impact Wrench (#2854-20)
 - 250 ft-lb
 - 2,400 RPM
- 4-1/2" / 5" Grinder with Paddle Switch, No-Lock (#2880-20)
 - 8,500 RPM
- (2) M18™ XC5.0 5Ah batteries • (1) 18V/12V multi-voltage charger



\$1448⁴⁵

MLW-3697-27

M18 FUEL™ 7-Tool Combo Kit

- (1) 1/2" Hammer drill/driver (2904-20)
- (1) 1/4" Hex impact driver (2953-20)
- (1) SAWZALL® Reciprocating saw (2821-20)
- (1) 6-1/2" Circular saw (2730-20)
- (1) 4-1/2" / 5" Braking grinder (2880-20)
- (1) 1/2" Mid-torque impact wrench (2962-20)
- (1) Work Light (2735-20)
- (2) M18™ REDLITHIUM™ XC5.0 batteries (48-11-1850)
- (1) M18™ & M12™ multi-voltage charger (48-59-1812)



Cordless Rotary Hammers



DEW-DCH172D2 **\$406⁵⁵**

ATOMIC 20V MAX* 5/8" SDS PLUS Brushless Rotary Hammer Kit

- Impact energy: 1.4 Joules
- No load speed: 0 - 1,060 RPM
- Blows/min: 0 - 4,980 BPM
- Optimal drilling range: 5/32" - 3/8"
- 2 modes: drill and hammer drill
- (2) 20V 2Ah batteries
- (1) Charger



DEW-DCH172B **\$274⁰⁵**

ATOMIC 20V MAX* 5/8" SDS PLUS Brushless Rotary Hammer (Bare Tool)



MLW-2715-22DE **\$923⁹⁵**

M18™ 1-1/8" SDS Plus Brushless Rotary Hammer with Dust Extractor Kit

- Impact energy: 3.3 ft-lb
- No load speed: 0-1,350 RPM
- Blows/min: 0-5,000 BPM
- 3 modes: rotary hammer, hammer only, rotation only
- (2) 18V XC5.0 batteries
- (1) 18V/12V charger



Cordless Nailers



DEW-DCN623D1 **\$470³⁵**

ATOMIC 20V MAX* Brushless 23GA Pin Nailer Kit

- Max. nail length: 1-1/2"
- Tool-free jam release and depth adjustment
- Includes low nail lockout system with LED indicator
- (1) 20V 2Ah battery
- (1) Charger



DEW-DCN623B **\$374⁶⁵**

ATOMIC 20V MAX* Brushless 23GA Pin Nailer (Bare Tool)



12V Drills & Drivers



MLW-2551-22 **\$247⁹⁵**

M12 FUEL™ SURGE™ 1/4" Hex Hydraulic Driver

- 0-3,200 RPM
- Up to 2X quieter operation
- (2) 12V CP2.0 batteries
- (1) 12V charger



MLW-2505-22 **\$298⁹⁵**

M12™ Installation Drill/Driver

- 300 in-lb
- 1/4" Hex, 3/8" chuck
- 4 attachments that connect in 16 different positions: Drill, Screwdriver, Right Angle, and Offset
- (2) 12V CP2.0 batteries
- (1) Charger



MLW-2407-22 **\$187⁹⁵**

M12™ 3/8" Drive Drill/Driver Kit

- 275 in-lb
- 0-400/0-1,500 RPM
- LED light
- (2) 12V CP1.5 batteries
- (1) 30-min charger



MLW-2494-22 **\$198⁹⁵**

M12™ Combo Drill/Driver Kit

- **3/8" Drill/Driver:**
 - 275 in-lb
 - 0-400, 0-1,500 RPM
- **1/4" Hex Impact Driver:**
 - 1,000 in-lb
 - 0-2,500 RPM / 0-3,300 IPM
- (2) 12V 1.5Ah batteries
- (1) 30-min charger



MLW-3497-22 **\$263⁶⁵**

M12™ Combo Hammer Drill/Driver & Impact Driver Kit

- **1/2" Hammer Drill/Driver (#3404-20):**
 - 400 in-lb / 1,550 RPM
- **1/4" Hex Impact Driver (#3453-20):**
 - 1,500 in-lb / 0-3,600 RPM
 - 4-mode drive control
- (2) 12V batteries: CP2.0 & XC 4.0
- (1) Charger



MLW-3403-20 **\$167⁹⁵**

M12™ 1/2" Drill/Driver (Bare Tool)

- 400 in-lb
- 1,500 RPM



18V Drills & Drivers



M18 FUEL™ 1/2" Drill/Drivers (Bare Tool)

- Only 6.9" in length



2903-20

2904-20

Item #	Description	Torque	RPM	
MLW-2903-20	Drill/Driver	1,400 in-lb	0-500/0-2,100	\$247.95
MLW-2904-20	Hammer Drill/Driver	1,400 in-lb	0-2,100	\$239.45

MLW-2607-22CT **\$256⁸⁵**

M18™ 1/2" Hammer Drill/Driver Kit

- 500 in-lb
- 0-450 / 0-1,800 RPM
- (2) 18V CP1.5 batteries
- (1) Charger



MLW-3697-22 **\$534⁶⁵**

M18™ Hammer Drill/Driver & Impact Driver Combo Kit

- **1/2" Hammer Drill/Driver (#2904-20):**
 - 1,400 in-lb
 - 0-2,100 RPM
 - 0-33,000 BPM
 - Auto Stop™ control mode
- **1/4" Hex Impact Driver (#2953-20):**
 - 2,000 in-lb
 - 0-3,900 RPM
 - 0-4,400 IPM
 - 4-mode drive control
- (2) M18™ XC5.0 5Ah batteries
- (1) 18V/12V multi-voltage charger



20V Drills & Drivers

DEWALT

DEW-DCF845P2 **\$400⁸⁵**
20V MAX* XR® 1/4" 3-Speed Impact Driver Kit

- Variable speed trigger
- 1,825 in-lb • 3,400 RPM
- 3-LED work light
- (2) 20V MAX* 5.0 Ah batteries
- (1) Charger



DEW-DCF845B **\$191⁵⁵**
20V MAX* XR® 1/4" 3-Speed Impact Driver (Bare Tool)

DEWALT

DEW-DCD777C2 **\$191⁵⁵**
20V MAX* Brushless Compact 1/2" Drill/Driver

- 340 unit watts out of power
- 0-1,600 RPM
- Clutch settings: 15
- (2) 20V MAX* batteries
- (1) Charger



DEWALT

DEW-DCD800D2 **\$282¹⁵**
20V MAX* Premium Brushless Compact 1/2" Drill/Driver Kit

- Clutch settings: 15
- 0-650/0-2,000 RPM
- Pivoting, 3-mode LED
- (2) 20V MAX* XR 2.0Ah batteries
- (1) Charger



DEWALT



DEW-DCD800B **\$194³⁵**
20V MAX* Premium Brushless Compact 1/2" Drill/Driver (Bare Tool)

DEW-DCD805D2 **\$293⁰⁵**
20V MAX* Premium Brushless Compact 1/2" Hammer Drill Kit

- Clutch settings: 15
- 0-650/0-2,000 RPM
- Pivoting, 3-mode LED
- (2) 20V MAX* XR 2.0Ah batteries
- (1) Charger



DEW-DCD805B **\$217³⁵**
20V MAX* Premium Brushless Compact 1/2" Hammer Drill (Bare Tool)

IR Ingersoll Rand.

IRC-W3111-K22 **\$580⁵⁵**
IQV® 20V Compact 1/4" Hex Impact Driver

- 3,400 in-lb • 2,800 RPM
- 3 speed options
- Shadowless 360° LED light
- (2) 20V Li-Ion batteries: 5.6Ah & 2.5 Ah
- (1) Charger



\$ While Qty's. Last



IRC-W3111 **\$312⁴⁵**
IQV® 20V Compact 1/4" Hex Impact Driver (Bare Tool)

60V Drills & Drivers

DEWALT

60v

FLEXVOLT

DEW-DCD130T1 **\$531²⁵**
FLEXVOLT® 60V MAX* 1/2" Mixer/Drill with E-Clutch® System

- 0-600 RPM
- (1) Flexvolt® 20V/60V MAX* 6.0 Ah battery
- (1) Fast charger



DEWALT

60v

FLEXVOLT

DEW-DCD460T2 **\$753³⁵**
FLEXVOLT® 60V MAX* VSR™ Stud and Joist 1/2" Drill with E-Clutch® System

- 0-300/0-1,250 RPM
- (2) Flexvolt® 20V/60V MAX* 6.0 Ah batteries
- (1) Fast charger



CORDLESS & ELECTRIC TOOLS

12V Ratchets



XTREME™ 12V MAX* Brushless Ratchets (Bare Tool)

- LED worklight



DCF503B
DCF504B
DCF503EB

Item #	Drive	Torque	Speed	
DEW-DCF504B	1/4"	40 ft-lb	0-250 RPM	\$205.85
DEW-DCF503B	3/8"	60 ft-lb	0-250 RPM	\$201.25
DEW-DCF503EB	3/8" (Extended Reach)	60 ft-lb	0-250 RPM	\$228.85



2557-20
2558-20

2560-20

2566-20
2567-20

2568-20
2569-20

M12™ Low Profile Ratchets (Bare Tool)

Item #	Drive	Features	Torque	Speed	
MLW-2566-20	1/4"	• High Speed • Compact Head	35 ft-lb	0-450 RPM	\$257.95
MLW-2568-20	1/4"	• High Speed • Extended Reach • Manual Capabil.	35 ft-lb (80 ft-lb manual)	0-450 RPM	\$327.95
MLW-2557-20	3/8"		55 ft-lb	0-200 RPM	\$257.95
MLW-2567-20	3/8"	• High Speed • Compact Head	35 ft-lb	0-450 RPM	\$257.95
MLW-2569-20	3/8"	• High Speed • Extended Reach • Manual Capabil.	35 ft-lb	0-450 RPM	\$327.95
MLW-2560-20	3/8"	• Extended Reach	55 ft-lb	0-200 RPM	\$327.95
MLW-2558-20	1/2"		60 ft-lb	0-175 RPM	\$257.25

MLW-49-16-2569 **\$37¹⁵**

M12 FUEL™ Extended Reach High Speed Ratchet Protective Boot

- For use with #2568-20 and #2569-20



M12 FUEL™ High Speed Compact Head Ratchet Kits

- 0.75" head profile
- (2) 12V M12™ CP2.0 batteries
- (1) Charger



Item #	Drive	Torque	Speed	
MLW-2566-22	1/4"	35 ft-lb	0-450 RPM	\$377.95
MLW-2567-22	3/8"	35 ft-lb	0-450 RPM	\$377.95

MLW-2560-21 **\$397⁹⁵** 3/8" Drive M12™ Li-Ion Low Profile Extended Reach Ratchet Kit

- 55 ft-lb • 0-200 RPM
- (1) 12V M12™ CP2.0 battery
- (1) Charger



M12™ Li-Ion Low Profile Ratchet Kits

- Powered by 12V M12™ CP2.0 batteries
- Kits include (1) charger



Item #	Drive	Torque	Speed	Batteries	
MLW-2557-22	3/8"	55 ft-lb	0-200 RPM	2	\$377.95
MLW-2558-22	1/2"	60 ft-lb	0-175 RPM	2	\$377.95

MLW-2569-21 **\$397⁹⁵**

3/8" Drive M12 FUEL™ Extended Reach High Speed Ratchet Kit

- 35 ft-lb • 0-450 RPM
- Can be used manually up to 120 ft-lb
- (1) 12V M12™ CP2.0 battery
- (1) Charger



2456-20
2457-20

2457-21

M12™ Li-Ion Ratchets

- 0-250 RPM

Item #	Drive	Includes	Torque	
MLW-2456-20	1/4"	Bare Tool	30 ft-lb	\$157.95
MLW-2457-21	3/8"	(1) 12V CP1.5 Battery, (1) Charger	35 ft-lb	\$247.95
MLW-2457-20	3/8"	Bare Tool	35 ft-lb	\$102.95

MLW-3050-21 **\$538⁹⁵**

M12™ INSIDER™ Extended Reach Box Ratchet Kit

- 65 ft-lb • 350 RPM
- (13) INSIDER™ sockets: 8-19mm & 21mm
- 1/4" Hex adapter
- 1/4" & 3/8" anvil adapters
- (1) M12™ High Output™ 2.5 Ah battery
- (1) M12™ charger



MLW-3050-20 **\$398⁹⁵**

M12™ INSIDER™ Extended Reach Box Ratchet (Bare Tool)

- 65 ft-lb • 350 RPM
- (13) INSIDER™ sockets: 8-19mm & 21mm
- 1/4" Hex adapter
- 1/4" & 3/8" anvil adapters



20V Ratchets



ATOMIC Compact Series™ 20V MAX* Brushless Ratchets (Bare Tool)

- 70 ft-lb • 0-250 RPM

Item #	Drive	
DEW-DCF513B	3/8"	\$255.75
DEW-DCF512B	1/2"	\$255.75



DEW-DCF510B **\$284⁰⁵**
20V MAX* XR® 3/8" & 1/2" Drive
Interchangeable Anvil
Brushless Sealed Head Ratchet
(Bare Tool)
• 75 ft-lb • 0-300 RPM

Cordless Tool Batteries & Chargers



Redlithium™ Battery Packs

Item #	Volt	Battery	Ah	
MLW-48-11-2420	12V	M12™ CP2.0	2.0	\$87.95
MLW-48-11-2430	12V	M12™ CP3.0	3.0	\$97.95
MLW-48-11-2440	12V	M12™ Ext. Capacity XC4.0	4.0	\$137.95
MLW-48-11-2460	12V	M12™ XC6.0	6.0	\$138.05
MLW-48-11-1820	18V	M18™ CP2.0	2.0	\$127.95
MLW-48-11-1835	18V	M18™ High Output™ CP3.0	3.0	\$103.85
MLW-48-11-1837	18V	M18™ High Output™ CP3.0 – 2-PACK	3.0	\$209.65
MLW-48-11-1840	18V	M18™ XC4.0	4.0	\$135.55
MLW-48-11-1842C	18V	M18™ XC4.0 – 2-PACK	4.0	\$303.95 <small>White Qty's. Last</small>
MLW-48-11-1852	18V	M18™ XC5.0 – 2-PACK	5.0	\$265.15
MLW-48-11-1865	18V	M18™ High Output™ XC6.0	6.0	\$168.35
MLW-48-11-1880	18V	M18™ High Output™ XC8.0	8.0	\$262.75
MLW-48-11-1812	18V	M18™ High Output™ HD12.0	12.0	\$330.25

MLW-48-59-1806 **\$104³⁵**

M18™ Six Pack Sequential Charger

- Charges M18™ compact batteries in 30 minutes and extended capacity (XC) batteries in 60 minutes



MLW-48-59-1807 **\$260⁴⁵**

M18™ & M12™ Rapid Charge Station

- Accepts up to (3) M18™ and (3) M12™ battery packs
- Charges (3) batteries simultaneously
- Charges each battery up to 40% faster



DCB205



DCBP034



DCBP520-2



Dewalt Battery Packs

Item #	Volt	Battery	Amp/Hr	
DEW-DCB205	20V	MAX* XR®	5Ah	\$130.85
DEW-DCBP034	20V	MAX* POWERSTACK™ Compact	1.7Ah	\$129.45
DEW-DCBP520	20V	MAX* POWERSTACK™	5Ah	\$161.25
DEW-DCBP520-2	20V	MAX* POWERSTACK™ – 2-PACK	5Ah	\$358.55

DEW-DCB1106 **\$120⁹⁵**

6 Amp Charger

- Compatible with all 12V MAX*, 20V MAX*, and FLEXVOLT® batteries



DEW-DCB104 **\$236⁹⁵**

Four-Port Simultaneous Fast Charger

- Charges 12V MAX*, 20V MAX*, and FLEXVOLT® 20V/60V MAX* batteries at the same time



Die Grinders

MLW-2485-20 **\$268⁰⁵**

M12™ 1/4" Right Angle Die Grinder (Bare Tool)

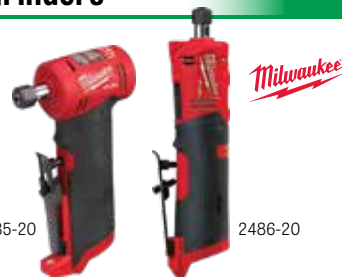

MLW-2486-20 **\$267⁹⁵**

M12™ 1/4" Straight Die Grinder (Bare Tool)



MLW-2485-22 **\$367⁹⁵**

M12™ 1/4" Right Angle Die Grinder Kit

- 0.3 HP motor
- 0-24,500 RPM
- 4-mode speed control
- (2) 12V M12™ CP2.0 batteries
- (1) Li-Ion charger



MLW-2486-22 **\$367⁹⁵**

M12™ 1/4" Straight Die Grinder Kit

- 0.3 HP motor
- 0-24,500 RPM
- 3-mode speed control
- (2) 12V M12™ CP2.0 batteries
- (1) Li-Ion charger



Cut-Off Tools

DEW-DCS438B **\$228⁸⁵**

20V MAX* XR® Brushless 3" Cut-Off Tool (Bare Tool)

- 20,000 RPM
 - Reversible rotation
- Includes:
- (1 each) Bonded abrasive wheel, diamond multi-material wheel & diamond tile wheel;
 - (1) Removable dust shroud



MLW-2522-21XC **\$262⁵⁵**

M12™ 3" Compact Cut Off Tool Kit

- 20,000 RPM
 - Reversible blade rotation
- Includes:
- (1) Metal Cut Off Wheel;
 - (1) Carbide Abrasive Blade;
 - (1) Diamond Tile Blade;
 - (1) Shoe Guard
 - (1) 12V XC4.0 battery
 - (1) Charger

MLW-2522-20 **\$156⁶⁵**

M12™ 3" Compact Cut Off Tool (Bare Tool)

- 20,000 RPM
- (1) 3" carbide abrasive blade (49-94-3005)
- (1) 3" diamond tile blade (49-94-3010)

CORDLESS & ELECTRIC TOOLS

FREE!

While quantities last

Buy #MLW-2880-22, and obtain #MLW-2821-20 for free: M18™ Sawzall® Reciprocating Saw (Bare Tool).



Cordless Grinders

MLW-2880-22 **\$627⁹⁵**
M18™ 4.5" / 5" Grinder Kit, Paddle Switch, No-Lock

- 8,500 RPM
- (2) M18™ 18V XC6.0 extended capacity batteries
- (1) 18V/12V multi-voltage rapid charger



FREE!

While quantities last

Buy #MLW-2880-20, get #MLW-48-11-1835: 18V CP3.0 Battery. February 1-March 30 Promotion.



M18™ Grinders/Cut-Off Tools (Bare Tools)

Item #	Wheel Diam.	RPM	Switch Type	
MLW-2880-20	4.5" / 5"	8,500	Paddle Switch	\$288.95
MLW-2881-20	4.5" / 5"	8,500	Slide Switch, Lock-On	\$206.65
MLW-2686-20	4.5" / 5"	11,000	Paddle Switch	\$211.05
MLW-2785-20	7" / 9"	6,600	Paddle Switch	\$397.95

FREE!

While quantities last

Buy #IRC-G5351-K22 and obtain #IRC-W3111 for free: 20V Compact Impact Driver (Bare Tool).



IR Ingersoll Rand.



IRC-G5351-K22 **\$762²⁵**
IQV® 20V 4.5"/5" Angle Grinder/Cut-Off Tool Kit

- 8,000 RPM
- (2) Guards: type 1 & type 27
- (2) 20V 5 Ah batteries • (1) Charger



IRC-G5351 **\$322⁸⁵**
IQV® 20V 4.5"/5" Angle Grinder/Cut-Off Tool (Bare Tool)

DEWALT 60V **FLEXVOLT**

DEW-DG418X2 **\$740⁹⁵**
FLEXVOLT® 60V MAX* 4.5"/6" Grinder Kit with Kickback Brake

- 3 HP • 9,000 RPM
- E-Clutch® system
- (2) 20V/60V MAX* 9Ah batteries
- (1) Fast charger



DEW-DCG405B **\$240³⁵**
20V MAX* XR® 4.5" Small Angle Grinder with Slide Switch and Kickback Brake (Bare Tool)
 • 9,000 RPM • 850 Watts



DEW-DCG413B **\$255⁷⁵**
20V MAX* XR® 4.5" Small Angle Grinder with Paddle Switch and Kickback Brake (Bare Tool)
 • 9,000 RPM • 850 Watts

DEW-DCG416VSB **\$340⁵⁵**
20V MAX* 4.5" / 5" Variable Speed Grinder with FLEXVOLT ADVANTAGE™ Technology (Bare Tool)

- 9,000 RPM
- The grinder has up to 48% more power when paired with a DCB606 FLEXVOLT® battery versus DCB205 20V MAX* battery. (Batteries sold separately.)



Electric Grinders

MAK-9557PBX1 **\$198⁷⁵**
7.5 Amp 4-1/2" Angle Grinder Kit

- 7.5 Amp AC/DC
- 11,000 RPM
- Includes diamond blade and grinding wheels



DWE4011

DWE4012



DWE402

4-1/2" Small Angle Grinders with One-Touch™ Guard

Item #	Amps AC/DC	Watts	RPM	
DEW-DWE4011	7.0 Amps	850 Watts	12,000 RPM	\$112.65
DEW-DWE4012	7.5 Amps	850 Watts	12,000 RPM	\$112.65
DEW-DWE402	11 Amps	1,400 Watts	11,000 RPM	\$150.25

MLW-6141-30 **\$165⁰⁵**
11 Amp 4-1/2" Small Angle Grinder
 • 11,000 RPM
 • Lock-on paddle



Saws



MLW-2520-20 **\$156⁷⁵**
M12™ HACKZALL®
Reciprocating Saw (Bare Tool)
 • 0-3,000 SPM
 • Stroke length: 5/8"



MLW-2420-21 **\$177⁹⁵**
M12™ HACKZALL®
One-Handed
Reciprocating Saw Kit
 • 0-3,000 SPM
 • Stroke length: 1/2"
 • Keyless blade clamp
 • (1) 12V CP1.5 battery
 • (1) Charger



MLW-2722-20 **\$327⁹⁵**
M18™ SUPER SAWZALL®
Reciprocating Saw (Bare Tool)
 • 0-3,000 SPM
 • Stroke length: 1-1/4"



MLW-2821-22 **\$578⁹⁵**
M18™ SAWZALL®
Reciprocating Saw
 • 0-3,000 SPM
 • 1-1/4" stroke length
 • (2) 18V XC5.0 batteries
 • (1) 18V/12V Multi-voltage charger



MLW-2821-20 **\$288⁹⁵**
M18™ SAWZALL®
Reciprocating Saw (Bare Tool)



MLW-2836-20 **\$208⁸⁵**
M18™ Oscillating
Multi-Tool (Bare Tool)
 • 10,000 to 20,000 OPM
 • (1) 1-3/8" HCS wood blade
 • (1) Multi-tool sanding pad
 • (1 each) 3-1/2" triangle sandpapers in 60/80/120/240 grit



\$399⁵⁵

DEW-DCS367P1
20V MAX* XR® Compact
Reciprocating Saw
 • Stroke length: 1-1/8"
 • Variable speed trigger delivers up to 2,900 SPM
 • 4-position blade clamp
 • (1) 20V Li-Ion battery, 5.0 Ah
 • (1) Charger



DEW-DCS367B **\$246⁸⁵**
20V MAX* XR®
Compact
Reciprocating
Saw (Bare Tool)



DEW-DWE305 **\$159⁸⁵**
12 Amp Reciprocating Saw
 • 0-2,900 SPM
 • Stroke length: 1-1/8"
 • Variable speed trigger
 • 4-position blade clamp



DEW-DCS692X2 **\$1285⁸⁵**
60V MAX* Brushless
9" Cut-Off Saw Kit
 • 6,600 RPM
 • 3-1/4" deep cut capacity
 • (2) 20V/60V batteries, 9.0Ah
 • (1) Fast charger
 • (1) Ceramic metal cut-off wheel
 • (1) Diamond cutting wheel



DEW-DCS692B **\$780¹⁵**
60V MAX* Brushless
9" Cut-Off Saw (Bare Tool)
 • 6,600 RPM
 • 3-1/4" deep cut capacity
 • (1) Ceramic metal cut-off wheel
 • (1) Diamond cutting wheel



MLW-2530-20 **\$204⁸⁵**
M12™ 5-3/8" Circular Saw
(Bare Tool)
 • No load RPM: 3,600
 • 1-5/8" deep cut capacity
 • LED light



MLW-6177-20 **\$299²⁵**
14" Abrasive Cut-Off Machine
 • 15 Amp, 4.0 HP motor
 • 3,900 RPM
 • 5" cutting capacity
 • 45° miter capacity with adjustable fence
 • Quick-adjust vise clamp



DEW-D28730 **\$297⁸⁵**
14" Chop Saw
 • 15 Amp • 2,300 W motor
 • 4,000 RPM
 • Quick-Lock vise for fast clamping
 • 5" cutting capacity
 • 45° adjustable fence



Polishers/Sanders

AST-3027 **\$143¹⁵**  **12V 3" Mini Pistol Grip Polisher**
 • 0-2,800/0-8,300 RPM • 2 speeds
 • 2-position side handle
 • Backing pad, foam polishing pad, foam compounding pad, and wool pad
 • (2) 12V 1.5Ah Li-Ion batteries • (1) Charger



AST-3026 **\$204⁹⁵**
12V 6" Variable Speed Random Orbital Palm Polisher
 • 2,500-5,000 OPM • 6 speeds • 5mm orbit
 • Black foam waxing and finishing pad
 • (2) 12V 2.0Ah batteries • (1) 1-Hour quick charger



AST-30570 **\$492⁵⁵**
20V 7" Brushless Variable Speed Rotary Polisher
 • 6 adjustable soft-start speed settings, 400-2,200 RPM
 • (2) 20V 4.0Ah batteries
 • (1) Quick charger



MLW-2438-22X **\$328⁹⁵**
M12™ Variable Speed Polisher/Sander Kit
 • Polishing RPM: 0-2,800
 • Sanding RPM: 0-8,300
 • (1) M12™ XC 3.0 battery
 • (1) M12™ CP1.5 battery
 • (1) Charger



MLW-2438-20 **\$198⁹⁵**
M12™ Variable Speed Polisher/Sander (Bare Tool)



MLW-2738-20 **\$347⁹⁵**
M18 FUEL™ 7" Variable Speed Polisher (Bare Tool)
 • 0-2,200 RPM



DEW-DCM849P2 **\$631⁷⁵**
20V MAX* XR® 7" Variable Speed Rotary Polisher Kit
 • 800-2,200 RPM
 • Side handle + D-handle
 • (2) 20V MAX* batteries, 5.0 Ah
 • (1) 12V/20V MAX* charger



DEW-DCM848P2 **\$663⁸⁵**
20V MAX* XR® 5" Var. Speed Random Orbit Polisher Kit
 • 2,000-5,500 OPM
 • Side handle
 • (2) 20V MAX* batteries, 5.0 Ah
 • (1) 12V/20V MAX* charger

\$320⁸⁵
 DEW-DCM849B
20V MAX* XR® 7" Variable Speed Rotary Polisher (Bare Tool)



\$343⁸⁵
 DEW-DCM848B
20V MAX* XR® 5" Variable Speed Random Orbital Polisher (Bare Tool)



12 Amp 7"/9" Variable Speed Polishers
 • 0-600/0-3,500 RPM • 1,250 W



Item #	Soft Start	
DEW-DWP849	No	\$303.55
DEW-DWP849X	Yes	\$298.45

DEWALT

DEW-7424XP **\$250⁰⁵**
4.5 Amp 6" Variable Speed Random Orbit Polisher
 • Sanding/polishing action
 • 2,500-6,800 orbits/min
 • Left or right side handle



PORTER CABLE
DEWALT

TIT-22610 **\$78⁶⁵**
10" Random Orbital Electric Polisher
 • 0.92 Amp
 • 3,000 RPM
 • Includes: (1) terry cloth bonnet & (1) synthetic wool bonnet



TITAN



ATD-10506 **\$244⁶⁵**
6 Amp 6" Random Orbital Polisher with Soft Start
 • 2,500-6,500 OPM
 • 5/8" diameter orbit
 • Includes side handle and D-handle

ATD



ATD-10511 **\$214⁴⁵**
11 Amp 7" Variable Speed Polisher
 • 1000 - 3000 RPM
 • Soft start
 • 9 ft. 10" cord

MAK-9237CX2 **\$543⁰⁵**
10 Amp 7" Variable Speed Polisher Kit with Foam Pads
 • 0-3,200 RPM
 • Soft start
 • Lock-on button for continuous use operation

Makita



Bandfiles

M12 FUEL™ Bandfiles (Bare Tools)
 • Best in class spot weld removal rate
 • 2 speed settings: 3,600 SFM/1,800 SFM
 • Forward & reverse
 • Variable speed trigger
 • 360° arm rotation
 • Includes (2) 60 grit sanding belts



Item #	Size	
MLW-2483-20	3/8" x 13"	\$327.95
MLW-2482-20	1/2" x 18"	\$327.95

Lockbolt Tools

MLW-2661-20 **\$1898⁹⁵**

M18 FUEL™ 1/4" Lockbolt Tool with ONE-KEY™ (Bare Tool)

- Pulling force: 4,500 lbs (20kN)
- Installs HUCK™ Bobtail®, Magna Grip® and C6L® Lockbolt Fasteners
- Compatible with HUCK™ Lockbolt Tip models 99-7932, 99-7932CC, 99-2555, 99-3417, 99-3201, 99-3204, and 99-3464
- **Option:** Installs HUCK™ Hucktainer Fasteners with purchase of Hucktainer Fastener Adaptor 49-16-2661HT
- **Option:** Installs 3/16" (4.8mm), 7/32" (6.0mm), 1/4" (6.4mm) and 9/32" (7.0mm) aluminum, steel, and stainless steel Blind Rivets with purchase of M18 1/4" Lockbolt to Blind Rivet Tool Conversion Kit 49-16-2661R



Pipe Threaders

MLW-2874-22HD **\$2330⁵⁵**

M18 FUEL™ Pipe Threader with One-Key™ Kit

- Threads from 1/8" up to 2" black iron pipe, stainless steel, and rigid metal conduit
- Die head lock
- Autostop™ kickback control
- (1) Threading support arm
- (2) 18V HD12.0 batteries
- (1) 18V/12V rapid charger



Rotary Tools

DRE-3000-1/24 **\$159⁶⁵**

3000 Series Variable Speed Rotary Tool Kit, 120V

- 1.2 Amps
- 5,000 - 35,000 RPM
- Includes: (1) attachment, (24) accessories



DRE-4000-6/50 **\$338⁶⁵**

4000 Series High Performance Rotary Tool Kit, 120V

- 1.6 Amps
- 5,000 - 35,000 RPM
- Includes: (6) attachments, (50) accessories



MLW-2460-20 **\$98⁰⁵**

M12™ Compact Rotary Tool (Bare Tool)

- Collet size: 1/32"-1/8" compatible with all current rotary tool accessories
- Variable speed: 5,000-32,000 RPM
- Includes: 5 cutting wheels, mandrel and wrench



Engravers

DRE-290-02 **\$38⁴⁵** **DREMEL**

115V Engraver Kit

- Comes with a letter/number template
- Engraves on metal, plastic, glass, ceramic, wood and leather



Drill Chucks & Adapters

TIT-16207 **\$15⁹⁵**

3/8" Keyless Chuck Adapter

- 1/4" Hex Shank
- 3/8" keyless chuck conversion for 1/4" impact driver



TIT-16235 **\$38⁰⁵**

1/4" Shank Right-Angle Drill Attachment

- 360° swivel handle



DEW-DWARA120 **\$28¹⁵**

1/4" Shank Impact Ready Right Angle Drill/Driver Attachment

- Compact 1.5" front-to-back design gives tighter access with your current drill/driver
- Magnetism for fastener retention



FLEXTORQ® Modular Right Angle Attachment

- Impact ready
- Eliminates the need for additional socket adapters in tight applications



Item #	Drive	
DEW-DWAMRA14FT	1/4"	\$35.95
DEW-DWAMRA38FT	3/8"	\$35.95



MLW-48-66-1375 **\$87⁹⁵**

Grip-Lok™ 1/2" Keyless Chuck with Hardened Jaws

- 1/2-20 thread
- All metal construction



JAC-30354MP **\$34⁸⁵**

3/8" (10mm) Capacity Hand-Tite® Keyless Drill Chuck

- 3/8-24 mount
- Superior gripping force



1/2" (13mm) Capacity Hand-Tite® Keyless Drill Chucks

- Superior gripping force



Item #	Mount	
JAC-JCM31037	3/8-24	\$90.45
JAC-JCM31038	1/2-20	\$90.45

Air Impact Wrenches



Made in Japan

1/4"

SPA-SP-7825S **\$315⁷⁵**
1/4" Drive Mini Compact Impact Wrench

- Max. torque: 94 ft-lb
- Composite housing
- Ultralight: 1.5 lbs
- 4.3" overall length
- dBA: 84.2



1/4"

IRC-2101KA **\$282¹⁵**
1/4" Drive Mini Impact Wrench Kit

- Max. torque: 55 ft-lb
- 14,500 RPM
- 1.5 lbs
- 83.5 dBA
- Includes 10-Pc 1/4" SAE & Metric Impact Socket Set



3/8"

Impact Wrenches

- 2-year warranty
- 3-year warranty on Vibrotherm Drive™ models



1320



1300-TH-A



1077-TH



1355-XL

Item #	Housing	Special Features	Loosening Torque	Max. Torque Reverse	Weight	dBA	
ACA-1320	Metal	Butterfly	100 ft-lb	80 ft-lb	1.1 lbs	86	\$362.85
ACA-1300-TH-A	Composite		600 ft-lb	450 ft-lb	2.63 lbs	86	\$366.25
ACA-1077-TH	Metal	Stubby	700 ft-lb	500 ft-lb	2.8 lbs	89	\$268.25
ACA-1355-XL	Composite		700 ft-lb	500 ft-lb	2.75 lbs	86	\$395.55
ACA-1076-XL	Composite	Compact	750 ft-lb	550 ft-lb	2.5 lbs	85	\$268.25
ACA-1059-VXL Vibrotherm Drive	Composite	Compact, Low Vibration	750 ft-lb	550 ft-lb	2.8 lbs	82	\$356.05



1076-XL



1059-VXL



3/8"

Impact Wrenches

- 2-year warranty on MAX Series



212



2015MAX



216B



2115TIMAX
2115QTIMAX

Item #	Housing	Special Features	Loosening Torque	Max. Torque Reverse	Weight	dBA	
IRC-212	Metal	Jumbo Hammer		150 ft-lb	2.89 lbs	96.0	\$312.65
IRC-2015MAX	Composite	Low Profile		180 ft-lb	3.4 lbs	96.6	\$641.25
IRC-216B	Metal	Lightweight		200 ft-lb	2.8 lbs	94.8	\$360.35
IRC-2115TIMAX	Composite	Titanium Hammer		300 ft-lb	2.49 lbs	106.3	\$399.75
IRC-2115QTIMAX	Composite	Quiet, Titanium Hammer		300 ft-lb	2.49 lbs	89.7	\$409.45
IRC-2115QXPA	Composite	Quiet, Lightweight		300 ft-lb	2.5 lbs	89.7	\$394.15
IRC-15QMAX	Composite	Quiet, Ultra Compact	475 ft-lb	380 ft-lb	2.4 lbs	89.7	\$317.75



2115QXPA

15QMAX

Air Impact Wrenches



7721



7722



7731C



7729

3/8" Impact Wrenches

Item #	Housing	Special Features	Loosening Torque	Max. Torque Reverse	Weight	dBa	
CPT-7721	Composite	Compact, Lightweight		81 ft-lb	1.1 lbs	92	\$264.15
CPT-7722	Metal	Compact		90 ft-lb	2.1 lbs	108	\$279.75
CPT-7731C	Composite	Compact, Lightweight		345 ft-lb	2.2 lbs	96	\$305.15
CPT-7729	Composite	S2S Reverse Technology		415 ft-lb	2.78 lbs	91	\$401.25



SX111



SX821A

3/8" Metal Impact Wrenches

Item #	Special Features	Max. Torque Reverse	Weight	dBa	
SUN-SX111	Palm Grip	75 ft-lb	2.5 lbs	110	\$118.05
SUN-SX821A		75 ft-lb	2.6 lbs	84	\$138.45



ONYX Palm Impact Wrenches

- Palm impact access
- Remote throttle
- Jumbo hammer
- 8,500 RPM
- 20" flexible hose with swivel ends and remote throttle means wherever your hand and arm can fit, you can now impact
- 3.46" impact head length, reactionless design means impact can be gripped with only a few fingers

Item #	Drive	Max. Torque	
AST-1831	3/8"	445 ft-lb	\$252.55
AST-1830	1/2"	445 ft-lb	\$252.55

ONYX Nano Straight Right Angle Impact Wrenches

- Extreme low profile, width of a credit card at 3.46" long
- Weight: 2.78 lbs
- dBA: 85



Item #	Drive	Max. Torque	
AST-1838	3/8"	415 ft-lb	\$247.95
AST-1832	1/2"	415 ft-lb	\$247.95

Nano Flex-Head Angle Impact Wrenches

- 180° flex head • 360° swivel handle
- Max. torque: 400 ft-lb
- Free speed: 8,000 RPM
- 3.34" overall length



Item #	Drive	
AST-1833	3/8"	\$303.95
AST-1834	1/2"	\$303.95



AST-1895 1/2" Drive THOR G2 Impact Wrench

- Max. torque: 1,020 ft-lb (compare to 1,650 lb nut-busting)
- 6,500 RPM • 92/103 dBA
- Floating air motor and twin-hammer assembly put the weight over the user's hand for balance
- 3 power selection settings
- 1/4" NPT adapter included if hi-flow 1/4" fittings are used





2236QTIMAX



2236QTIMAX-2



2236QTIMAX



Ingersoll Rand® 2236 Max

Industry's most compact high torque 1/2" drive impact wrench with an interchangeable anvil system. The patented Drive Xchange System™ lets you switch out anvils without clunky adapters that can drain your tool's power.

- 1,500 ft-lbs of nut busting torque
- 7,500 RPM
- Lightweight (4.4 & 4.6 lbs)
- Quiet at 94.2 dBA



Item #	Available Configurations	
IRC-2236QTIMAX	1/2" Standard Friction Ring Anvil	\$559.95
IRC-2236QTIMAX-2	1/2" x 2" Extended Friction Ring Anvil	\$589.95
IRC-2236OPTIMAX	1/2" Standard Pin Anvil	\$569.95



AK32H		
AK33H		
AK42H		
AK43H		
AK62H		
EAK62H		
EAK44H		
A31H	3/8" Standard Friction Ring	
A41H	1/2" Standard Friction Ring	
AP41H	1/2" Standard Pin Style	
EA42H	1/2" x 2" Friction Ring	
EA44H	1/2" x 4" Friction Ring	
EA46H	1/2" x 6" Friction Ring	
EA48H	1/2" x 8" Friction Ring	
EA410H	1/2" x 10" Friction Ring	
A61H	3/4" Standard Friction Ring	
EA66H	3/4" x 6" Friction Ring	



Interchangeable Anvil Sets

- Available drive sizes: 3/8", 1/2", 3/4"
- Compatible with all DXS2™ tools

Item #	Anvil Sizes Included in Set	Model No. References	
IRC-AK32H	3/8", 1/2"	A31H, A41H	\$78.75
IRC-AK33H	3/8", 1/2", 3/4"	A31H, A41H, A61H	\$97.55
IRC-AK42H	1/2" x 2", 3/4"	EA42H, A61H	\$83.45
IRC-AK43H	1/2" x 2", 1/2" x 4", 3/4"	EA42H, EA44H, A61H	\$117.55
IRC-AK62H	1/2", 3/4"	A41H, A61H	\$78.75
IRC-EAK62H	3/4", 3/4" x 6"	A61H, EA66H	\$117.55
IRC-EAK44H	1/2" x 4", 1/2" x 6", 1/2" x 8", 1/2" x 10"	EA44H, EA46H, EA48H, EA410H	\$218.25

Air Impact Wrenches



1/2"

Impact Wrenches

- 2-year warranty
- 3-year warranty on Vibrotherm Drive™ models

Item #	Housing	Special Features	Loosening Torque	Max. Torque Reverse	Weight	dBA	
ACA-1057-TH	Composite	Stubby	700 ft-lb	500 ft-lb	2.8 lbs	89	\$271.15
ACA-1375-XL	Composite		700 ft-lb	500 ft-lb	2.75 lbs	86	\$411.55
ACA-1058-VXL Vibrotherm Drive	Composite	Compact, Low Vibration	750 ft-lb	550 ft-lb	2.8 lbs	82	\$356.05
ACA-1056-XL	Composite	Compact	750 ft-lb	550 ft-lb	2.5 lbs	85	\$273.05
ACA-1000-TH	Composite		1,000 ft-lb	800 ft-lb	4.5 lbs	86	\$378.55
ACA-1431	Metal		1,000 ft-lb	800 ft-lb	5.7 lbs	109	\$216.15
ACA-1431-2	Metal	2" Anvil	1,000 ft-lb	800 ft-lb	6.0 lbs	109	\$225.75
ACA-1200-K	Composite KEVLAR™	Twin Clutch	1,295 ft-lb	900 ft-lb	4.5 lbs	86	\$485.15
ACA-1150	Composite		1,295 ft-lb	900 ft-lb	4.5 lbs	86	\$454.05
ACA-1250-K	Composite KEVLAR™	Twin Clutch	1,300 ft-lb	950 ft-lb	4.5 lbs	86	\$576.75
ACA-1178-VXL Vibrotherm Drive	Composite	Compact, Low Vibration	1,300 ft-lb	950 ft-lb	4.5 lbs	86	\$476.65
ACA-1178-VXL-2 Vibrotherm Drive	Composite	2" Extended Anvil	1,300 ft-lb	950 ft-lb	4.7 lbs	86	\$511.65
ACA-1125	Composite		1,250 ft-lb	1,000 ft-lb	3.8 lbs	87	\$412.45



1/2"

Impact Wrenches

- 1 year warranty

Item #	Housing	Special Features	Loosening Torque	Max. Torque Reverse	Weight	dBA	
MUK-294 114/SIGNAL	Metal (Green)	3-Speed Control		1,180 ft-lb	3.9 lbs	94.2	\$330.55
MUK-294 114/ORANGE	Metal (Orange)	3-Speed Control		1,180 ft-lb	3.9 lbs	94.2	\$330.55

294 114/SIGNAL

294 114/ORANGE



Air Impact Wrenches



734H



7732C



749



7741



7748

1/2" Impact Wrenches

• 2-year warranty on CP Classic Tools

Item #	Housing	Special Features	Loosening Torque	Max. Torque Reverse	Weight	dBA	
CPT-734H	Metal	CP Classic		445 ft-lb	5.1 lbs	93	\$259.95
CPT-7732C	Composite	Compact, Lightweight		460 ft-lb	2.2 lbs	95.5	\$266.65
CPT-749	Metal	CP Classic		610 ft-lb	5.5 lbs	96	\$430.75
CPT-7741	Composite	3 Settings in Forward		715 ft-lb	4.96 lbs	93	\$269.65
CPT-7748	Composite	Lightweight		920 ft-lb	4.6 lbs	93	\$297.15



1/2" Impact Wrenches

• 2-year warranty on MAX Series

Item #	Housing	Special Features	Loosening Torque	Max. Torque Reverse	Weight	dBA	
IRC-2025MAX	Composite	Low Profile		180 ft-lb	3.4 lbs	96.6	\$660.05
IRC-236	Metal			450 ft-lb	5.3 lbs	90.3	\$252.05
IRC-36QMAX	Composite		640 ft-lb	470 ft-lb	2.6 lbs	91.3	\$332.55
IRC-244A	Metal			500 ft-lb	6.0 lbs	93	\$468.35
IRC-2130	Composite			550 ft-lb	4.2 lbs	94.5	\$363.15
IRC-231HA	Metal			590 ft-lb	5.8 lbs	94	\$287.85
IRC-231HA-2	Metal	2" Anvil		590 ft-lb	6.1 lbs	94	\$338.35
IRC-231C	Metal	Heavy Duty		600 ft-lb	5.8 lbs	99	\$243.95
IRC-232TGSL	Composite			625 ft-lb	6.0 lbs	105.3	\$491.75
IRC-2135QXPA	Composite	Quiet	1,100 ft-lb	780 ft-lb	4.0 lbs	90.7	\$452.35
IRC-2235QTIMAX	Composite	Quiet	1,300 ft-lb	900 ft-lb	4.7 lbs	91.9	\$659.95
IRC-2235TIMAX	Composite		1,350 ft-lb	930 ft-lb	4.6 lbs	98.0	\$599.95
IRC-2235TIMAX-G	Composite		1,350 ft-lb	930 ft-lb	4.6 lbs	98.0	\$599.95
IRC-2235TIMAX-O	Composite		1,350 ft-lb	930 ft-lb	4.6 lbs	98.0	\$599.95
IRC-2235TIMAX-R	Composite		1,350 ft-lb	930 ft-lb	4.6 lbs	98.0	\$599.95



FREE!
While quantities last

Buy #IRC-2235QTIMAX, 2235TIMAX, 2235TIMAX-G, 2235TIMAX-O or 2235TIMAX-R and obtain #IRC-36QMAXB: 1/2" Dr. Ultra-Compact Impact Wrench.



Air Impact Wrenches



3/4"

Impact Wrenches

- 2-year warranty
- 3-year warranty on Vibrotherm Drive™ models

Item #	Housing	Special Features	Loosening Torque	Max. Torque Reverse	Weight	dBa	
ACA-1600-TH-A	Composite	Super Duty	1,600 ft-lb	1,400 ft-lb	8.1 lbs	86	\$828.75
ACA-1770-XL	Composite	Super Duty	1,600 ft-lb	1,400 ft-lb	7.4 lbs	91.3	\$844.85
ACA-1777	Metal	Super Duty	1,600 ft-lb	1,400 ft-lb	7.5 lbs	92	\$779.65
ACA-1680-A	Metal	Twin Hammer	1,600 ft-lb	1,400 ft-lb	12.5 lbs	89	\$802.35
ACA-1778-VXL Vibrotherm Drive	Composite	Compact, Low Vibration	1,700 ft-lb	1,450 ft-lb	7.4 lbs	94	\$928.95

FREE!

Buy #ACA-1778-VXL and obtain #ACA-1431 for free: 1/2" Drive Impact Wrench.



3/4"

Impact Wrenches

- 2-year warranty on CP Classic Tools

Item #	Housing	Special Features	Loosening Torque	Max. Torque Reverse	Weight	dBa	
CPT-772H	Metal	Oil Bath Clutch		1,000 ft-lb	10.5 lbs	96	\$660.15
CPT-7762	Composite	Ultra Compact		1,050 ft-lb	6.4 lbs	92.8	\$633.35
CPT-7763	Composite	Compact		1,200 ft-lb	11.6 lbs	96	\$790.45
CPT-7769	Composite	Compact, Lightweight		1,440 ft-lb	7.4 lbs	96.8	\$943.35



3/4"

Impact Wrenches

- 2-year warranty on MAX Series

Item #	Housing	Special Features	Loosening Torque	Max. Torque Reverse	Weight	dBa	
IRC-259	Metal			1,050 ft-lb	8.8 lbs	96.5	\$721.45
IRC-261	Metal			1,200 ft-lb	12 lbs	98.4	\$951.65
IRC-2145Q1MAX	Composite	Quiet	1,700 ft-lb	1,350 ft-lb	7.4 lbs	91.1	\$916.55
IRC-2146Q1MAX	Metal	Quiet	2,000 ft-lb	1,450 ft-lb	7.8 lbs	88.8	\$1008.15

3/4"

MUK-294 117 **\$791³⁵**
3/4" Drive Impact Wrench

- Max. torque: 1,918 ft-lb
- Metal housing
- 3-speed control
- Weight: 7.0 lbs • dBA: 105.1

3/4"

AST-1896 **\$376⁶⁵**
3/4" Drive THOR G2 Impact Wrench

- Max. torque: 1,100 ft-lb (compare to 1,700 ft-lb nut-busting)
- 6,500 RPM • 92/103 dBA
- Floating air motor and twin-hammer assembly put the weight over the user's hand for balance
- 3 power selection settings
- 1/4" NPT adapter included if hi-flow 1/4" fittings are used



Air Impact Wrenches



1880-P-A



1992



1993-1-VXL



1993-VXL



1994

1" Impact Wrenches

• 2-year warranty

Item #	Housing	Special Features	Loosening Torque	Max. Torque Reverse	Weight	dBa	
ACA-1880-P-A	Metal	Twin Hammer	1,900 ft-lb	1,700 ft-lb	23.5 lbs	88	\$1098.05
ACA-1992	Metal	8" Anvil	2,000 ft-lb	1,800 ft-lb	26 lbs	109	\$723.05
ACA-1993-1-VXL	Composite	Low Vibration	2,300 ft-lb	2,100 ft-lb	18.5 lbs	108	\$1216.15
ACA-1993-VXL	Composite	Low Vibration, 6" Anvil	2,300 ft-lb	2,100 ft-lb	20.2 lbs	108	\$1257.05
ACA-1994	Metal	Super Duty, 8" Anvil	2,500 ft-lb	2,300 ft-lb	35 lbs	105	\$839.15



7779



7776



796

1" Impact Wrenches

Item #	Housing	Special Features	Loosening Torque	Max. Torque Reverse	Weight	dBa	
CPT-7779	Composite	Lightweight		1,440 ft-lb	7.7 lbs	96.8	\$947.05
CPT-7776	Metal			1,770 ft-lb	24.7 lbs	93	\$1158.65
CPT-7783-6	Composite	6" Anvil		1,770 ft-lb	20.9 lbs	113	\$1205.85
CPT-7782-6	Composite	6" Anvil		1,920 ft-lb	25.6 lbs	100	\$1006.55
CPT-796	Metal			2,000 ft-lb	20 lbs	101	



7782-6
7783-6



FREE!

While quantities last

Buy #IRC-2155QIMAX and obtain #TDF-213123 for free: Rechargeable Soldering Iron Kit.



2155QIMAX



295A



2146Q2MAX

2175MAX



FREE!

While quantities last

Buy #IRC-2175MAX and obtain #IRC-2175MAX-TK1: Tune-Up Kit for 2175 Series Impact Wrench.



285B-6



2850MAX-6



1" Impact Wrenches

• 2-year warranty on MAX Series

Item #	Housing	Special Features	Loosening Torque	Max. Torque Reverse	Weight	dBa	
IRC-2155QIMAX	Composite	Quiet	1,700 ft-lb	1,350 ft-lb	7.4 lbs	91.1	\$1194.45
IRC-2146Q2MAX	Metal	Quiet	2,000 ft-lb	1,450 ft-lb	8.0 lbs	88.8	\$1163.75
IRC-285B-6	Metal	6" Anvil		1,475 ft-lb	24.6 lbs	103.4	\$949.35
IRC-295A	Metal			1,475 ft-lb	22 lbs	101.1	\$1160.25
IRC-2175MAX	Composite			2,000 ft-lb	17.97 lbs	103.6	\$1270.85
IRC-2850MAX-6	Composite	6" Anvil		2,100 ft-lb	21.58 lbs	96	\$1130.95

FREE!

Buy #IRC-2850MAX-6 and obtain a \$50 Esso Gift Card for free.



Impact Wrench Lifters

MRI-MMIWSS



Impact Boom – 50 Lb Capacity Mobile Impact Wrench Holder

- Up, down and 360°, the swivel hook and supporting bar will follow you in any bolting patterns while maintaining your impact wrench still
- Fix and swivel casters
- Impact wrench not included

MARTINS INDUSTRIES



Impact Wrench Boots

1056-XLBB



AIRCAT PNEUMATIC TOOLS

1150-BB
1600-THBB

1200-KBR
1355-XLBR

Protective Boots for Aircat Impact Wrenches

Item #	Fits Aircat Models	Price
ACA-1056-XLBB	1056-XL and 1076-XL	\$26.95
ACA-1150-BB	1150, 1000, 1000-TH, and 1000-TH-2	\$36.45
ACA-1200-KBR	1200-K and 1250-K	\$37.65
ACA-1355-XLBR	1355-XL and 1375-XL	\$34.05
ACA-1600-THBB	1600-TH, 1600-TH-A and 1700-XL	\$55.85



35-BOOT

231-BOOT

2115M-BOOT

2130-BOOT

2235M-BOOT

2145M-BOOT

W5132-BOOT

W7152-BOOT

W7150-BOOT



Protective Boots for Ingersoll Rand Impact Wrenches

Item #	Fits Ingersoll Rand Models	Price
IRC-35-BOOT	35MAX and 15QMAX	\$30.65
IRC-231-BOOT	231C, 231HA, 231HA-2	\$21.25
IRC-2115M-BOOT	2115TiMAX, 2115PTiMAX, 2115QTiMAX	\$32.45
IRC-2130-BOOT	2130, 2130-2	\$32.45
IRC-2235M-BOOT	2235TiMAX Series Tools	\$32.45
IRC-2145M-BOOT	2145QiMAX	\$42.35
IRC-W5132-BOOT	W5132 & W5152 (Cordless Impact Wrenches)	\$34.65
IRC-W7152-BOOT	W7152 & W7252 (Cordless Impact Wrenches)	\$34.65
IRC-W7150-BOOT	W7150 & W7250 (Cordless Impact Wrenches)	\$34.65

Air Tool Maintenance



Ingersoll Rand Impact Wrench Hammer & Anvil Repair Kits



231B-THK1

Item #	For IR Impact Wrench Models:	Price
IRC-231B-THK1	231C, 231HA, 231HA-2	\$161.85
IRC-2115-THK1	2115Ti and 2115QTi	\$129.15
IRC-2135-THK1	2135Ti and 2135QTi	\$161.85



JCL-PTK-CK

\$96⁴⁵

Snap Ring Installation & Removal Tool Kit for Air & Cordless Impact Wrenches

- 1 Snap ring pliers
- 1 ClipKey® for 1/4", 3/8" & 1/2" tools
- 6 each of 1/4", 3/8" & 1/2" clips & O-rings
- Works for all major models of impact wrenches including Milwaukee, Snap-On, Dewalt and Makita

Anvil Retainer Clips and O-Rings for Air and Cordless Impact Wrenches

- CLIPAD™/CLIPKEY® not included



Item #	Drive Size	Contents per Pack	Qty of Packs	Price
JCL-JC2505	1/4"	(3) Clips + (3) O-Rings	5	\$19.45
JCL-JC38012	3/8"	(3) Clips + (3) O-Rings	12	\$90.55
JCL-JC50012	1/2"	(3) Clips + (3) O-Rings	12	\$90.55
JCL-JC7505	3/4"	(1) Clip + (1) O-Ring	5	\$46.35
JCL-JC10005	1"	(1) Clip + (1) O-Ring	5	\$57.15

STK-16600

\$77¹⁵



Air Tool Oiler

- Works with all models of air hammers, air sanders, air ratchets and air ratchet heads, etc.
- Adjustable oil flow: .05 cc or up to about four drops
- Self centering, non-drip oil dispenser head



IRC-115-LBK1

\$59³⁵

Composite Housing Impact Wrench Care Kit

- Includes 4 fl. oz #10Z4 oil, 4 oz #115 grease, and grease gun

Air Ratchets



Composite Air Ratchets

• 2-year warranty

Item #	Features	Drive	Torque	RPM	
ACA-804	Mini	1/4"	30 ft-lb	280	\$236.35
ACA-808-15-25	Long Reach, 15.3"	1/4"	30 ft-lb	200	\$249.95
ACA-811	3-Position 30° Flex Head	1/4"	35 ft-lb	240	\$302.05
ACA-807-25	Stubby, Lightweight	1/4"	35 ft-lb	300	\$147.85
ACA-800	Mini, Single Pawl	1/4"	35 ft-lb	320	\$193.95
ACA-810-RW	Mini, Impacting	3/8"	50 ft-lb	550	\$266.35
ACA-808-22-A	Long Reach, 22"	3/8"	80 ft-lb	200	\$313.55
ACA-805-HT-22	High Torque, 22" Long Reach	3/8"	130 ft-lb	200	\$496.55
ACA-802	Twin Pawl	3/8"	70 ft-lb	280	\$211.35
ACA-812-RW	Impacting	3/8"	80 ft-lb	350	\$356.05
ACA-805-HT	High Torque	3/8"	130 ft-lb	180	\$309.75
ACA-809-SH-5	Sealed Flat Head	1/2"	65 ft-lb	350	\$386.05
ACA-805-HT-5	High Torque	1/2"	130 ft-lb	180	\$333.85
ACA-805-HT-22-5	High Torque, 22" Long Reach	1/2"	130 ft-lb	200	\$496.55



Air Ratchets

Item #	Features	Drive	Torque	RPM	
CPT-825C	Stubby	1/4"	26 ft-lb	280	\$238.65
CPT-828	Standard Duty	3/8"	10-50 ft-lb	150	\$226.55
CPT-886	Compact Head	3/8"	10-50 ft-lb	160	\$166.25
CPT-7829	Composite Grip	3/8"	10-70 ft-lb	225	\$274.55
CPT-828H	Standard Duty	1/2"	10-50 ft-lb	150	\$236.75
CPT-7829H	Composite Grip	1/2"	10-70 ft-lb	225	\$280.45



Air Ratchets

Item #	Features	Drive	Torque	RPM	
IR-105-D2	Mini - 7.3"	1/4"	25 ft-lb	250	\$205.85
IRC-105-L2	Mini - 8.4"	1/4"	25 ft-lb	250	\$244.05
IRC-1105MAX-D2	Premium Mini	1/4"	30 ft-lb	300	\$276.45
IRC-107XPA	Standard	3/8"	54 ft-lb	160	\$192.55
IRC-1207MAX-D3	Premium	3/8"	65 ft-lb	220	\$300.25
IRC-1211MAX-D3	High Speed	3/8"	66 ft-lb	625	\$370.15
IRC-109XPA	High Torque	3/8"	76 ft-lb	220	\$278.15
IRC-1077XPA	Standard	1/2"	54 ft-lb	160	\$233.55
IRC-1211MAX-D4	High Speed	1/2"	66 ft-lb	625	\$370.15
IRC-1099XPA	High Torque	1/2"	76 ft-lb	220	\$334.55

Air Drills



Reversible Composite Air Drills

• 2-year warranty

Item #	Chuck	RPM	Motor	
ACA-4337	3/8" Keyed	1,600	0.75 HP	\$230.65
ACA-4338	3/8" Keyless	1,800	5/8 HP	\$199.75
ACA-4439	3/8" Keyed	2,400	0.7 HP	\$302.05
ACA-4450	1/2" Keyed	400	5/8 HP	\$220.95



Air Drills

• 2-year warranty on CP Classic Tools

Item #	Chuck	RPM	Motor	Reversible	
CPT-7300C	1/4" Keyed	3,300	0.3 HP	NO	\$223.35
CPT-879C	3/8" Keyed	2,100	0.4 HP	YES	\$202.45
CPT-785QC	3/8" Keyless	2,400	0.5 HP	NO	\$251.05
CPT-785	3/8" Keyed	2,400	0.5 HP	NO	\$242.85
CPT-789R-26	3/8" Keyed	2,600	0.4 HP	YES	\$387.15
CPT-789HR	1/2" Keyed	500	0.4 HP	YES	\$525.85
CPT-785H	1/2" Keyed	500	0.5 HP	NO	\$408.15



Reversible Air Drills

• Jacobs® chuck and key

Item #	Chuck	RPM	Motor	
SUN-SX223	3/8"	1,800	0.35 HP	\$129.45
SUN-SX221B	1/2"	500	0.5 HP	\$252.55



Air Drills

Item #	Chuck	RPM	Motor	Reversible	
IRC-7807R-A	3/8"	1,800	1/3 HP	YES	\$213.95
IRC-7802A	3/8"	2,000	1/2 HP	NO	\$240.45
IRC-7802RA	3/8"	2,000	1/2 HP	YES	\$293.35
IRC-7802RAKC	3/8" Keyless	2,000	1/2 HP	YES	\$306.05
IRC-7803A	1/2"	500	1/2 HP	NO	\$368.05
IRC-7803RA	1/2"	500	1/2 HP	YES	\$418.15
IRC-7803RAKC	1/2" Keyless	500	1/2 HP	YES	\$432.75

Air Screwdrivers



AST-810T **\$154⁶⁵**
1/4" Reversible Internal Adjust Screwdriver
 • 1,800 RPM
 • Quick change bit retainer



IRC-371-A **\$259⁴⁵**
1/4" Reversible Screwdriver
 • 2,000 RPM
 • Torque range: 0-13 ft-lb

Air Die Grinders



1/4" Composite Die Grinders

• 2-year warranty

Item #	Head	Features	Motor	RPM	
ACA-6201	Straight		1/2 HP	22,000	\$155.65
ACA-6285	Straight		3/4 HP	20,000	\$178.15
ACA-6290	Straight	Reversible	3/4 HP	20,000	\$184.05
ACA-6260	Straight		1 HP	22,000	\$186.25
ACA-6205	Straight	Mini	1/3 HP	25,000	\$135.05
ACA-6270	Straight	6" Extended	1 HP	20,000	\$367.15
ACA-6255	90° Angle		1/2 HP	20,000	\$186.25
ACA-6250	90° Angle	Mini	1/3 HP	18,000	\$164.45
ACA-6280	90° Angle		3/4 HP	18,000	\$211.35
ACA-6265	90° Angle		1 HP	18,000	\$357.95
ACA-6295	115° Angle		0.6 HP	18,000	\$224.85



1/4" Die Grinders

Item #	Head	Motor	RPM	
COMPOSITE Housing				
SUN-SX5203	90° Angle	0.25 HP	20,000	\$190.45
SUN-SX5206	90° Angle	0.5 HP	18,000	\$179.75
SUN-SX5210	Straight	1 HP	20,000	\$217.85
ALUMINUM Housing				
SUN-SX232B	90° Angle	0.25 HP	20,000	\$119.05
SUN-SX230B	Straight	0.25 HP	22,000	\$79.85
SUN-SX231B	Straight, MINI	0.25 HP	25,000	\$70.65



Chicago Pneumatic

1/4" Die Grinders

• 2-year warranty on CP Classic Tools

Item #	Head	Motor	RPM	
CPT-876	Straight	0.30 HP	30,000	\$130.55
CPT-875	90°	0.30 HP	22,500	\$116.15
CPT-7405	Straight	0.34 HP	28,000	\$165.75
CPT-7406	90°	0.34 HP	23,000	\$178.45
CPT-7408	120°	0.34 HP	23,000	\$178.55
CPT-860	Straight	0.54 HP	24,000	\$244.85
CPT-860ES	Straight, 6" Extended	0.54 HP	24,000	\$454.15
CPT-872	Straight	0.60 HP	22,000	\$99.95



ATD-2132 **\$73²⁵**
1/4" Air Die Grinder
• 22,000 RPM



ATD-21310 **\$171⁷⁵**
1/4" Mini Angle Air Die Grinder/
Surface Conditioning Kit
• 22,000 RPM
• (25) 2" coarse grit surface conditioning discs
• 2" Quick-change disc holder



SUN-SX264K **\$163¹⁵** 1/4" & 1/8" Mini 90° Angle Die Grinder Kit

- .25 HP
- 1/8" & 1/4" shank grinding stones
- 2" & 3" backing pads
- 2" & 3" abrasive discs



Air Die Grinders



1/4" Die Grinders

Item #	Head	Motor	RPM	
IRC-301B	90° Angle	0.25 HP	21,000	\$120.15
IRC-307B	Straight	0.25 HP	28,000	\$106.95
IRC-302B	90° Angle	0.33 HP	20,000	\$187.85
IRC-308B	Straight	0.33 HP	25,000	\$161.45
IRC-308BK	Straight	0.33 HP	25,000	\$208.45
IRC-5102MAX	90° Angle	0.40 HP	20,000	\$337.85
IRC-5108MAX	Straight	0.40 HP	25,000	\$303.95

AST-2181B **\$189²⁵**

ONYX Die Grinder & Double Cut Carbide Rotary Bur Set

- #AST-202: composite body 1/4" medium die grinder, 22,000 RPM
- #AST-2181: 8-pc double cut carbide rotary bur set



AST-217 **\$168²⁵**

ONYX 13" Long Extended Shaft Die Grinder - 1/4" Collet

- 20,000 RPM



Made in Japan



1/4" Heavy Duty Die Grinders

Item #	Head	Motor	RPM	
SPA-SP-7211	90° Angle	1/2 HP	18,000	\$175.25
SPA-SP-7212	120° Angle	1/2 HP	18,000	\$222.55
SPA-SP-7220	Straight	1/2 HP	20,000	\$133.65



SUN-SX2PK **\$113⁵⁵**
2 Pack 1/4" Mini Die Grinder Set

- .25 HP
- Includes straight (#SX231B) and 90° angle (#SX264) die grinders



SUN-SX300 **\$130³⁵**
2 Pack 1/4" Mini Die Grinder Set

- .25 HP
- Straight (#SX307B): 22,000 rpm
- 90° angle (#SX301B) 28,000 rpm



AST-1221 **\$230⁹⁵**

Composite Body Die Grinders and Rotary Bur Set

- #AST-1240: 1/4" 90° die grinder: 20,000 RPM
- #AST-1205: 1/4" mini die grinder: 25,000 RPM
- #AST-2181: 8-pc double cut carbide bur set



ATD-2122 **\$151³⁵**

2 Pack 1/4" Mini Die Grinder Set

- 90° angle: 20,000 RPM
- Straight: 25,000 RPM



CPT-9104Q **\$212⁹⁵**
High Speed Pencil Grinder for Precision Work

- 3mm & 1/8" collets
- 60,000 RPM



IRC-320PG **\$225⁵⁵**
Slim Profile Pencil Grinder

- 1/8" collet
- 56,000RPM



SUN-SX245K **\$176⁷⁵**

Pencil-Type Air Die Grinder Kit

- 54,000 rpm
- (10) 1/8" shank stones



AIR TOOLS & ACCESSORIES

Air Grinders



Angle Grinders

- 2-year warranty

Item #	Size	Motor	RPM	
ACA-6220	2"	0.5 HP	15,000	\$239.25
ACA-6340-A	4.5"	1 HP	11,000	\$378.55
ACA-6380	5"	2.3 HP	12,000	\$675.85

SPA-SP-1257 **\$476¹⁵**

5" Angle Grinder

- 12,000 RPM
- 1.0 HP



CPT-854E **\$524²⁵**

5" Angle Grinder

- 12,000 RPM
- 0.7 HP
- 2-year warranty



CPT-7550B **\$465²⁵**

5" Angle Grinder

- 12,000 RPM
- 1.1 HP



CPT-857 **\$828⁶⁵**

7" Angle Grinder

- 7,500 RPM
- 1.3 HP
- 2-year warranty



IRC-3445MAX **\$554⁷⁵**

4.5" MAX Angle Grinder

- 12,000 RPM
- 0.88 HP motor



GRI-29306 **\$10¹⁵**

7" Disc Backing Pad

- Use with 7" angle grinder and resin fiber discs
- Max: 10,000 RPM



Air Engravers

IRC-140EP **\$252⁰⁵**

5.5" Long Engraving Pen with Rubber Grip

- 11,400 BPM
- Precision on even the hardest surfaces, from alloys to brittle ceramics



Air Hammers



MUK-290 300 **\$897⁷⁵**

Heavy Duty Vibro-Impact® Air Hammer

- Shank: 15mm Hex (.590")
- 2,500 BPM
- 1 year warranty



MUK-290 318 **\$79⁶⁵**

Heavy Duty Vibro-Impact® Flat Chisel

- Shank: 15mm Hex (.590")
- For use with #MUK-290 300



.401 Shank Air Hammers

Item #	Description	BPM	Stroke	
IRC-119MAXX	Vibration Reduced, Long Barrel, 5 Chisels	2,530	3.5"	\$331.45
IRC-123MAXX	Vibration Reduced, Short Barrel, 5 Chisels	3,500	2.6"	\$331.45
IRC-135MAXX	Heavy Duty, Feather Trigger, 5 Chisels	2,600	3"	\$450.45
IRC-135MAX	Heavy Duty, Feather Trigger	2,600	3"	\$404.55
IRC-117K	Standard Duty, 5 Chisels	2,000	3.5"	\$166.85
IRC-121/Q	Super Duty	3,000	2.28"	\$229.85
IRC-121-K6	Super Duty, 6 Chisels	3,000	2.28"	\$248.85

AST-4980 **\$505⁹⁵**

.498" Shank Super Duty Air Hammer/Riveter

- 1,800 BPM
- Stroke: 2-11/16"
- Feathering trigger control



Air Hammers



Air Hammers

- 2-year warranty on CP Classic Tools

Item #	Shank	BPM	Stroke	
CPT-714	Tool Only	.401	2,000	3.5" \$794.75
CPT-714K	Kit	.401	2,000	3.5" \$818.05
CPT-7150	Tool Only	.401	2,300	3.5" \$132.05
CPT-7150K	Kit	.401	2,300	3.5" \$183.65
CPT-7165K	Kit	.401 – Long Barrel	2,500	3.5" \$433.05
CPT-7110K	Kit	.401	3,200	2.63" \$209.55
CPT-7160K	Kit	.401 – Short Barrel	3,500	2.64" \$409.75
CPT-717	Tool Only	.498	1,800	2.69" \$1017.35
CPT-717K	Kit	.498	1,800	2.69" \$1231.55



2-Year Warranty



ACA-5100-A **\$318⁴⁵**
.401" Composite Long Stroke Air Hammer Kit
 • 3,000 BPM
 • Piston stroke: 2-5/8"
 • Includes 5-chisel set



2-Year Warranty

ACA-5250-A-T **\$514⁴⁵**
.401" Super Duty Air Hammer

- 2,500 BPM
- Piston stroke: 3"
- Includes quick change chisel retainer
- 4 position built-in air regulator



Air Hammer Chisels

SLY-15400 **\$289⁷⁵**
3-Pc Quick Change Air Hammer Bits, .401 Shank

- 6", 9" and 18" shafts
- (3) Hammer head tips for different application needs: nylon (soft), aluminum (medium), steel (hard)



ATD-5730 **\$56⁴⁵**
9-Pc All-Purpose .401" Shank Air Hammer Chisel Set



ATD-5736 **\$96⁷⁵**
6-Pc 7" Extra Long .401" Shank Air Hammer Drift Set
 • 3/16" (5.2mm), 1/4" (6.5mm), 9/32" (6.9mm), 5/16" (7.7mm), 3/8" (9.3mm), 1/2" (12.7mm)



AJX-A9022 **\$141⁸⁵**
4-Pc Front End Chisel Set

- Nos.: A901, A921, A903-3/4, A903-1

AJX-A9029 **\$195⁹⁵**
9-Pc Master Chisel Set

- Nos.: A905, A906, A907, A908, A909, A910, A911, A912, A932



Flat Chisels



Item #	Shank	Blade	Length	
AJX-A910-1/2	.401	1/2"	6.5"	\$19.65
AJX-A910	.401	3/4"	6.5"	\$16.35
AJX-A910-11	.401	3/4"	11"	\$22.75
AJX-A910-18	.401	3/4"	18"	\$37.65
AJX-A910-1-1/2	.401	1.5"	6.5"	\$22.15
AJX-A910-11-1-1/2	.401	1.5"	11"	\$33.55
AJX-A910-2	.401	2"	7"	\$26.35
AJX-A960	.498	5/8"	7"	\$27.05
AJX-A960-18	.498	5/8"	18"	\$45.85

Rivet Cutters



Item #	Shank	Blade	Length	
AJX-A912	.401	5/8"	5-3/4"	\$16.35
AJX-A962	.498	5/8"	5-3/4"	\$27.05

Vee Chisel/Spot Weld Breaker



Item #	Shank	Length	
AJX-A914	.401	6-1/4"	\$19.25

Air Hammer Chisels



Sheet Metal Cutter/Ripper

• Up to 16 gauge (1/16" thick)



Item #	Shank	Length	
AJX-A907	.401	5-3/8"	\$27.55

Bushing Remover



Item #	Shank	Length	
AJX-A904	.401	6-1/4"	\$20.05

Bushing Splitter



Item #	Shank	Length	
AJX-A906	.401	6-1/4"	\$23.25

Tapered Punches



Item #	Shank	Length	
AJX-A911	.401	6-1/2"	\$16.35
AJX-A961	.498	7"	\$27.05

Straight Punches



Item #	Shank	Length	
AJX-A913	.401	6-1/2"	\$14.05
AJX-A913-18	.401	18"	\$33.95
AJX-A963	.498	7"	\$22.75

Hammers



Item #	Shank	Diameter	Length	
AJX-A945	.401	1"	4-1/4"	\$23.15
AJX-A945-7	.401	1"	7"	\$35.35
AJX-A967	.498	1"	4-1/4"	\$35.45

Smoothing Hammers



Item #	Shank	Diameter	Length	
AJX-A1602	.401	1"	3"	\$47.25

Rivet Chisels, 3-1/2" Long



Item #	Rivet Type & Size	Shank	
AJX-A1604	Round – 3/16"	.401	\$28.55
AJX-A1620	Brazier – 3/16"	.401	\$27.35
AJX-A1621	Brazier – 1/4"	.401	\$32.75
AJX-A1636	Universal – 3/16"	.401	\$27.35
AJX-A1638	Universal – 5/16"	.401	\$33.85

Ball Joint & Tie Rod Separators



Item #	Shank	Size	Length	
AJX-A903-3/4	.401	3/4"	7-1/4"	\$61.25
AJX-A903-1	.401	1"	7-1/4"	\$61.25
AJX-A968	.498	1-1/4"	7-1/4"	\$100.15

Universal Joint & Tie Rod Tool



Item #	Shank	Length	
AJX-A901	.401	4-1/4"	\$28.25

Tail Pipe Cutter



Item #	Shank	Length	
AJX-A902	.401	6-7/8"	\$19.35

Muffler Cutter



Item #	Shank	Length	
AJX-A908	.401	7-1/2"	\$29.85

Wide Chisel & Scraper



Item #	Shank	Blade	Length	
AJX-A905	.401	1-5/16"	6-1/4"	\$19.45
AJX-A955	.498	1-5/16"	7"	\$28.35

Offset Scraper Chisel



Item #	Shank	Length	
AJX-A922	.401	6-3/4"	\$22.05

Double Blade Panel Cutters



Item #	Shank	Length	
AJX-A909	.401	6"	\$23.15
AJX-A959	.498	6-7/8"	\$35.75

Roll Pin Drivers



Item #	Shank	Punch Size	Length	
AJX-A1102	.401	1/4"	7-1/2"	\$28.95
AJX-A1103	.401	5/16"	7-1/2"	\$28.95
AJX-A1104	.401	3/8"	7-1/2"	\$28.95

Brake Pin & Bushing Driver Sets



Shank	Item #	Length		Item #	Length	
.401	AJX-A1166	10.5"	\$178.95	AJX-A1176	14"	\$232.85
.498	AJX-A954	10.5"	\$187.55	AJX-A979	14"	\$244.95

Air Hammer Chisels



AST-49804 **\$33⁵⁵**
**0.498 Shank Air Hammer
 1/2" Bolt Buster**

- Features a 3/4" hex for wrenching on while you hammer on the socket and bolt to bust it free



AST-49805 **\$62⁸⁵**
**0.498 Shank Air Hammer
 Pickle Fork Ball Joint
 Separator**

- Size: 15/16"



AST-49803 **\$87⁵⁵**
3-Pc Chisel & Hammer Bit Set

- .498 Shank
- 7" long "non-turn" type slotted chisel
- 1" diameter straight shoulder hammer bit
- 1.25" diameter rounded hammer bit



**.498 Shank
 Air Hammer
 Bits**

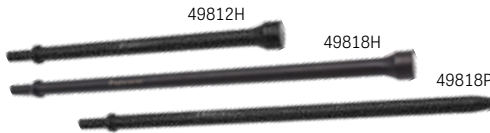

Item #	Description	Length	Diam.	
AST-49812H	Hammer Bit	12"	1"	\$40.85
AST-49818H	Hammer Bit	18"	1"	\$54.25
AST-49818P	Taper Punch	18"	3/8"	\$36.95

**Pneumatic
 Scrapers**



Item #	Shank	Width	Length	
MAY-32016HT	.401	2"	18"	\$72.35
MAY-32017HT	.401	2"	24"	\$76.65



**Pneumatic
 Round
 Hammers**

Item #	Shank	Diameter	Length	
MAY-32001HT	.401	1"	12"	\$61.15
MAY-32002HT	.401	1"	18"	\$79.45
MAY-32003HT	.401	1"	24"	\$82.25

MAY-37323 **\$165⁸⁵**

**.401 Shank 18" Long
 Pneumatic Punch &
 Scraper Set**

- Scraper: 1-1/8" x 18"
- Taper punches: 3/8" x 18" and 1/8" x 18"



SGT-91125 **\$40⁶⁵**
.401 Smoothing Hammer

- Face diameter: 1"



SGT-91975 **\$48⁵⁵**
**3/4" Pneumatic
 Cold Chisel**

- 18" long • .401" shank

SGT-91950 **\$50³⁵**
2" Pneumatic Scraper

- Blade has slight offset for easy use
- .401" shank

Air Hammer Retainers



Kwik Change Retainers for Air Hammers

.401" Shank

AJX-A3300-1 **\$81⁶⁵**

- Fits **American Pneumatic**: all models
- Fits **Desouter**: all models
- Fits **Ingersoll Rand**: models #121, 132, 772, AV10-12-13
- Fits **Sioux**: models #270-272
- Fits **Superior**: all models



AJX-A3300-9 **\$81⁶⁵**

- Fits **Chicago Pneumatic**: models #9311-9315, 711-715
- Fits **Cleco**: models #E3-E4-E15-E16
- Fits **Craftsman**: model #18800
- Fits **Dayton**: all models
- Fits **Ingersoll Rand**: models #115, 116, 117

.498" Shank

AJX-A3200-1 **\$172⁰⁵**

- Fits **Ingersoll Rand**: model #AVC-26



AJX-A3200-3 **\$172⁰⁵**

- Fits **Chicago Pneumatic**: models #4447, #717
- Fits **Florida Pneumatic**: model #FP660

ATD-2052 **\$46⁴⁵**

**.401 Shank
 Quick Change Retainer
 for Air Hammers**



AST-49801 **\$76⁸⁵**

**.498 Shank Quick Change Retainer
 Chuck for Air Hammers**



SGT-94400 **\$48⁰⁵**

Quick Change Chisel Retainer

- Securely holds .401" shank chisels
- Fits most popular air hammers



ATD-6750 **\$2²⁹**
**.401 Shank Air Hammer
 Retainer Spring**



**.401" Shank
 Retaining Springs**



A895
 A895-IR



A897
 A897-IR

Item #	Description	Fits Models	
AJX-A895	Standard Beehive Spring	CPA 046096	\$6.55
AJX-A895-IR	Standard Beehive Spring	AVC-183	\$6.55
AJX-A897	Mech Aid Spring	CPA 046095	\$6.95
AJX-A897-IR	Mech Aid Spring	AVC-183A	\$7.35

AIR TOOLS & ACCESSORIES

Air Needle Scalers

- CPT-7125 **\$346⁶⁵**
13" Long Needle Scaler
 • 4,000 BPM
 • 1.3" stroke
 • Delivered with 2 sets of needles:
 (19) 1/8" (3mm) for standard usage
 (29) 5/64" (2mm) for finer usage



Chicago Pneumatic

- CPT-7120 **\$366⁸⁵**
18" Long Needle Scaler/Chisel
 • 4,800 BPM • 1.18" stroke
 • (19) 1/8" (3mm) steel needles
 • 1.37" (35mm) width chisel



- ACA-6390 **\$284⁶⁵**
Compact Needle Scaler
 • 4,800 BPM
 • 1-1/4" stroke
 • (12) 1/8" x 5" needles



- IRC-125-A **\$355⁶⁵**
18.3" Needle Scaler
 • 19 needles x 1/8" diameter
 • 4,800 BPM • 1-1/8" stroke length



IR Ingersoll Rand.

Air Punch/Flange Tools



SUNEX TOOLS

- SUN-SX280 **\$125⁹⁵**
5mm Punch/Flange Tool
 • Heavy duty head turns 360° to easily crimp flanges or lap joint sheets and pipes
 • Turn head 180° to punch a clean, accurate 3/16" (5mm) hole for welding fasteners
 • Aluminum cutting capacity: 0.08"
 • Steel cutting capacity: 0.05"

- SUN-SX278C **\$196⁷⁵**
8mm Punch/Flange Tool
 • Head swivels 360°
 • 5/16" (8mm) diameter hole punch/crimp/flange in up to 14 gauge steel capacity
 • Aluminum cutting cap.: 0.07"
 • Steel cutting capacity of 0.04"
 • 7/8" gap

Air Scrapers

Astro

- AST-1750K **\$107⁶⁵**
Air Scraper Kit
 • Includes 4 specialty blades
 • Removes gaskets, paint, rust, undercoating, seam sealers, and other materials



Air Nibblers / Air Shears

- ACA-6330 **\$219⁰⁵**
High Performance Air Nibbler
 • 2,600 strokes/min
 • Cutting capacity: 18 gauge
 • 2-year warranty



- IRC-7802SA **\$373³⁵**
Heavy Duty Air Shear
 • 4,200 SPM
 • Clean cuts in cold rolled steel up to 20 gauge



IR Ingersoll Rand.

Air Reciprocating Saws

Chicago Pneumatic

- CPT-7901 **\$303¹⁵**
9" Long Low Vibration Reciprocating Saw
 • Premium tool for all cutting applications
 • 3/8" (10 mm) stroke length • 10,000 strokes/min



- CPT-7900 **\$214³⁵**
8.5" Long Rugged Saw
 • Compact and lightweight for all general cutting
 • 3/8" (10 mm) stroke length
 • 10,000 strokes/min
 • Includes (1) each 18T, 28T, 32T replacement blades



- ACA-6355-A **\$388⁸⁵**
14" Long Reciprocating Air Saw
 • Dual-speed design for control
 • Quick change blade
 • Cuts 1/4" thick mild steel and steel pipe up to 3"
 • 5,000 SPM



- IRC-429 **\$191⁵⁵**
Heavy Duty Reciprocating Saw
 • 10,000 strokes/min
 • 3/8" (10mm) stroke length
 • Comes with 6 cutting blades



IR Ingersoll Rand.

- IRC-529 **\$342⁰⁵**
Vibration Reduced Reciprocating Saw
 • 9,500 strokes/min
 • 3/8" (10mm) stroke length
 • Comes with 6 cutting blades



- ATD-2142A **\$120⁵⁵**
Air Body Saw
 • Cuts up to 1/16" steel or 1/2" plywood
 • 10,000 SPM
 • .354" stroke length
 • Included blades: (1) 18 TPI and (1) 24 TPI



ATD AIR

Air Cut-Off Tools

NEW

MUELLER
LUBRY

MUK-297 003 **\$223⁸⁵**
2" Mini Angle Disc Cutter

- For use in hard to reach areas
- Works with 2" cutting and grinding wheels
- Center bore: 0.4"
- Adjustable spark protector



SP
SP AIR

Made in Japan



3" Flex Head Cut-Off Tools
• 3-position flexible head

Item #	Features	RPM	
SPA-SP-7231	Non Reversible Head	18,000	\$278.45
SPA-SP-7231R	REVERSIBLE Head	12,000	\$323.25

ACA-6530 **\$284⁶⁵**
3" Flex Head Cut-Off Tool
• 3 position flex head
• 18,000 RPM • 0.5 HP
• 2-year warranty



ACA-6525-A **\$240²⁵**
3" In-Line Cut-Off Tool
• 18,000 RPM
• 0.6 HP
• 2-year warranty



ACA-6520 **\$172²⁵**
3" Composite Reversible Cut-Off Tool
• 18,000 RPM • 0.5 HP
• Cuts 3/8" rolled steel/18 gauge
• 2-year warranty



ACA-6505 **\$153⁶⁵**
3" Composite Cut-Off Tool
• 20,000 RPM
• 0.5 HP
• Cuts 3/4" rolled steel/18 gauge
• 2-year warranty



ACA-6275-A **\$454⁰⁵**
4" Composite Inside Cut-Off Tool
• 14,000 RPM • 1 HP
• 11 position rotational guard
• 2-year warranty



ATD-2139 **\$79⁶⁵**
3" Utility Cut-Off Tool
• 18,000 RPM



ATD
AIR

CPT-9116 **\$425⁵⁵**
4" Extended Cut-Off Tool
• 14,000 RPM
• 1 HP
• 11 position rotational guard

Chicago
Pneumatic



CPT-861 **\$285⁰⁵**
2-7/8" High-Speed Cut-Off Tool
• 20,000 RPM • 0.5 HP

Chicago
Pneumatic



CPT-874 **\$151⁸⁵**
2-7/8" High-Speed Cut-Off Tool
• 22,000 RPM • 0.5 HP



Astro
AST-209 **\$157³⁵**
ONYX In-Line 3" Cut-Off Tool
• 15,000 RPM
• Motor: 1/2 HP



SUNEX
TOOLS
SUN-SX233A **\$109⁰⁵**
3" Utility Cut-Off Tool
• 20,000 RPM



SUN-SX6210 **\$181¹⁵**
3" Reversible Cut-Off Tool
• 18,000 RPM
• 2-year warranty



IRC-326 **\$121⁸⁵**
3" Heavy Duty Air Cut-Off Tool
• 18,000 RPM



IR
Ingersoll Rand

IRC-426 **\$180¹⁵**
3" Reversible Composite Cut-off Tool
• 20,000 RPM
• Comes with 5 cut-off wheels



Air Sanders



ATD-2088 **\$139⁷⁵**
6" Random Orbital Sander

- Compact, lightweight, and low vibration
- Variable speed control
- Orbit: 3/16"
- 10,000 RPM



6700-3-336



6700-5-336



6700-6-332



6700-6-336



6700-6G

Non-Vacuum Low Vibration "Lube Free" Sanders

• Hook & loop pads • 2-year warranty

Item #	Pad	Motion	Orbit	RPM	
ACA-6700-3-336	3"	Orbital	3/16"	11,000	\$278.85
ACA-6700-5-336	5"	Orbital	3/16"	11,000	\$278.85
ACA-6700-6-336	6"	Orbital	3/16"	11,000	\$278.85
ACA-6700-6-332	6"	Orbital	3/32"	11,000	\$278.85
ACA-6700-6G	6"	Geared Planetary	3/16"	900	\$437.05



6" Pad Non-Vacuum Random Orbital Air Sanders



7215
7225
7255

Item #	Pad Type	Orbit	Motor	RPM	
CPT-7225	PSA Pad	3/32"	0.29 HP	12,000	\$316.55
CPT-7255	PSA Pad	3/16"	0.29 HP	12,000	\$317.95
CPT-7215	PSA Pad	3/8"	0.29 HP	12,000	\$323.45

CPT-870 **\$138³⁵** **6" Dual Action Sander**

• General-duty sander with rotary or random orbital options

- 3/8" orbit
- 10,000 RPM
- PSA sanding pad



CPT-7265S **\$516⁷⁵** **7" Heavy-Duty Vertical Sander**

• 0.7 HP

- 5,000 RPM



317-B



311A



4151



313-B



328B

Air Sanders

Item #	Description	Pad	Orbit	RPM	
IRC-317-B	High Speed Sander	3" & 5"		18,000	\$148.25
IRC-311A	Dual-Action Quiet Sander	6"	3/16"	12,000	\$160.35
IRC-4151	Vacuum-Ready Random Orbital Sander	6"	3/16"	12,000	\$281.15
IRC-313-B	Heavy-Duty Angle Sander	7"		5,000	\$423.25
IRC-328B	Dual-Action Geared Sander	8"	5/32"	825	\$261.15



ACA-6315-K **\$250⁸⁵** **2" & 3" Mini Orbital Sander Kit**

• Low weight composite housing

- Feather speed control trigger
- 16,000 RPM

Kit includes:

- (1) 2" and (1) 3" backing pads
- (10 each) 2" and 3" sanding discs in 320, 400 and 600 grit



CPT-7200S **\$241⁸⁵** **2" & 3" Mini Random Orbital Sander Kit**

• Compact & lightweight

- Excellent for small area repair
- 15,000 RPM

Kit includes:

- (1) 2" and (1) 3" backing pads
- (10 each) 2" and 3" sand papers in 320, 400 and 600 grit



CPT-7202D **\$244³⁵** **3" Mini Pistol Disc Sander Kit**

• Roloc pad

- Adjustable power regulator
- Progressive throttle
- 15,000 RPM

Kit includes:

- (1) 3-inch backing pad
- (10 each) 3-inch 80, 100 and 120 grit sanding discs
- (1 each) 3-inch fine, medium and coarse surface prep discs



Air Sanders



ProFinisher™ Random Orbital Sanders

Item #	Description	Pad	Orbit	RPM	Price
HUT-4500	- Ultra Fine Finishing	6" PSA	3/32"	10,000	\$725.25
HUT-3500	- Low Profile - Ultra Fine Finishing	6" PSA	3/32"	10,000	\$689.15
HUT-500	- Pre & Post Paint	6" PSA	3/32"	10,000	\$402.85
HUT-500H	- Pre & Post Paint	6" Velcro	3/32"	10,000	\$411.55
HUT-600	- Aggressive Material Removal	6" PSA	3/16"	10,000	\$402.85
HUT-600H	- Aggressive Material Removal	6" Velcro	3/16"	10,000	\$411.55
HUT-700	- Fastest, Aggressive Material Removal	6" PSA	5/16"	12,000	\$420.35
HUT-720**	- Fastest, Aggressive Material Removal - Requires External Vacuum Source	6" Velcro	5/16"	12,000	\$489.35
HUT-503	- Fine Pre & Post Paint	3" Velcro	3/32"	12,000	\$402.85

** Model 720 requires either 5301-2 or 5301-5 to complete vacuum connection.



ONYX 6" Finishing Palm Sanders

Item #	Pad Type	RPM	Stroke	Price
AST-322	Hook & Loop Pad	10,000	3/16" (5mm)	\$176.75
AST-322P	PSA Pad	10,000	3/16" (5mm)	\$176.75



6" Non-Vacuum Dynorbital-Spirit® Random Orbital Sanders

- Low profile design with ergonomic grip
- Colour-coded levers
- One-hand speed control

Item #	Orbit	RPM	Price
DYB-59040	3/32"	12,000	\$342.45
DYB-59025	3/16"	12,000	\$342.45
DYB-59010	3/8"	12,000	\$349.45

AST-32020 **\$183⁴⁵** ONYX Flex-Head 2" Micro Air Sander

- 0.35HP • 0-19,000 RPM
- 2" pad for hook & loop abrasive



ACA-6320 **\$284⁶⁵** Mini Spot Sander/Polisher

- 1/8" orbit
- Supplied with Velcro® 1.25" and 2" round and a triangular pad
- 2-year warranty



ACA-6700-JBS-332 **\$348³⁵** Jitterbug Sander

- 10,000 RPM • 3/32" orbit
- 7.75" x 2.75" rectangle Velcro® pad
- Reduced-vibration, lubrication-free motor
- 2-year warranty

HUT-2000 **\$924⁸⁵** Straight Line Sander

- For aggressive sanding • Reciprocal action
- 3,000 SPM • Pad size: 2-3/4" x 16-1/2"
- Pad type: PSA



HUT-3800 **\$802⁴⁵** Orbital Long Board Sander

- For aggressive sanding
- 8500+ SPM
- Pad size: 2-3/4" x 16-1/2"
- Pad type: PSA



IRC-315 **\$234⁴⁵** Twin Piston Straight Line Air Sander

- 2-3/4" x 17-1/2"
- 1" stroke • 3,000 SPM



CPT-7268 **\$284⁰⁵** Heavy Duty In-Line Sander

- 2.75" x 17.5"
- 1" stroke • 5,000 RPM

ACA-6325 **\$287⁵⁵** 1/2" x 18" Belt Sander

- 0.6 HP
- 18,000 RPM
- 360° sanding arm adjustments



Adjustable Power Air Belt Sanders

- 0.6 HP motor
- 20,000 RPM



Item #	Belt Size	Belts Included with Sander	Price
IRC-360-313	3/8" x 13"	1 of each: 60, 80 and 100 grit	\$193.45
IRC-360-418	1/2" x 18"	1 of each: 60, 80 and 100 grit	\$226.85

Air Sanders

CPT-9779 **\$349⁶⁵**
3/8" x 13" Belt Sander

- 22,000 RPM
- Handle exhaust and swivel air inlet
- Adjustable sanding arm



AST-3039 **\$325⁸⁵**
Adjustable 3/4" x 20.5" Air Belt File/Sander

- For cleaning, weld prep and material removal on tubing or any radiused work piece
- 16,000 RPM
- Includes: (1) 80 grit belt and (1) 100 grit belt



Air Belt Sanders

- Variable speed control

Item #	Belt Size	Belts Included with Sander	
AST-3036	3/8" x 13"	40, 60 and 80 grit belts	\$156.65
AST-3037	1/2" x 18"	40, 60 and 80 grit belts	\$192.45
AST-3035	3/4" x 20.5"	80 and 100 grit belts	\$268.05

Sanding Belts

- 10 belts per pack



Item #	Belt Size	Grit	Fits	
AST-303640Z	3/8" x 13"	40	#AST-3036	\$14.45
AST-303660Z	3/8" x 13"	60	#AST-3036	\$14.45
AST-303680Z	3/8" x 13"	80	#AST-3036	\$14.45
AST-303760Z	1/2" x 18"	60	#AST-3037	\$16.05
AST-303780Z	1/2" x 18"	80	#AST-3037	\$16.05
AST-3037100Z	1/2" x 18"	100	#AST-3037	\$16.05
AST-303540Z	3/4" x 20.5"	40	#AST-3035, #AST-3039	\$20.05
AST-303560Z	3/4" x 20.5"	60	#AST-3035, #AST-3039	\$20.05
AST-303580Z	3/4" x 20.5"	80	#AST-3035, #AST-3039	\$20.05
AST-3035100Z	3/4" x 20.5"	100	#AST-3035, #AST-3039	\$20.05

GRI-29308 **\$14⁰⁵**
5-Pc 7" Polishing/Sanding Set

- (1) Hook and loop backing pad, 5/8"-11 thread UNC spindle
- (3) Sanding discs, 40/120/240 grits
- (1) Cotton/nylon polishing pad
- Maximum 8,500 RPM



GRI-29303 **\$21⁰⁵**
7" Compound Foam Pad, with Velcro

GRI-29305 **\$22⁵⁵**
7" Wool Buffing Pad, with Velcro

6" Quick Change Sanding Disc Pads

- 5/16" x 24 threads • .625" thick
- Max. 10,000 RPM

Item #	Pad Type	
ATD-2076	Velcro	\$16.75
ATD-2078	Stick-On	\$15.45



Air Polishers

CPT-7269P **\$521⁰⁵**
7" Heavy-Duty Angle Polisher

- Rugged 0.7 HP (500 W) motor
- 2,600 RPM
- Speed control switch
- 7" pad and 8" "Flex-Edge" polishing pad



IR Ingersoll Rand.

IRC-314-B **\$464²⁵**
7" Air Angle Polisher and Buffer

- 0.5 HP motor • 3,000 RPM



CPT-7201P **\$239⁰⁵**
3" Mini Disc Polisher Kit

- Excellent for small area repair
- Kit includes:
 - (1) 3" hook & loop backing pad
 - (2) 3.5" foam compounding pads (white/yellow)
 - (1) 3.5" wool buffing pad



AST-3055 **\$121¹⁵**
3" Mini Air Polishing Kit

- 3" mini polisher, 2,500 RPM
- 3" sanding/polishing back-up pad
- 3" wool buffing pad
- 3" polishing foam pad - Yellow
- 3" polishing foam pad - White



AST-3059 **\$172²⁵**
Headlight Restoration & Metal Polishing Kit

- Ideal for headlight restoration
- Ideal for restoring aluminum and magnesium rims, engine parts, motorcycle parts and plastics
- Easily removes clear coats from weathered wheels
- Create CUSTOM looks on parts by giving them a polished or a flat finish



Tire Buffers

IRC-327LS-A **\$205⁴⁵**
Tire Buffer

- 1/2 HP
- 3,000 RPM
- 3/8" Hex quick change



CP Chicago Pneumatic

CPT-873K **\$194¹⁵**
Low Speed Tire Buffer Kit

- 2,800 RPM
- Includes whip hose and exhaust hose



Air Regulators



SGT-98025 **\$11.75**
Brass Air Regulator



Air Swivels

TIT-19444 **\$9.15**
360° Swivel Connector
• For use with 1/4" NPT fittings and quick connect adapters



AST-3SB40 **\$22.25** **Astro**
360° High Flow Air Swivel Connector
• Enjoy more power and RPM
• 1.5x the body size of traditional swivels with 2x the air passageway size • 1/4" NPT inlet



360° Swivel Splitters
• 1/4" NPT input/output
• Universal couplers for use with A, M, and T-style male plugs

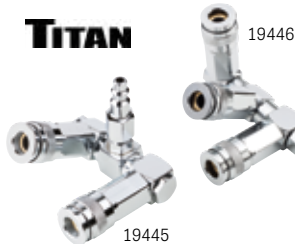

360° Air Flex Swivel Connectors

Item #	NPT	Max. CFM	
CPT-8940171569	1/4"	25 CFM	\$154.75
CPT-8940171571	3/8"	74 CFM	\$197.45
CPT-8940171567	1/2"	74 CFM	\$197.45



Air Couplers & Plugs

5-in-1 Universal Quick-Connect Couplers
• Accepts all major interchanges: Industrial (M-Style), High Flow (V-Style), Automotive (T-Style), ARO (A-Style) & Lincoln (L-Style)
• 1/4" FNPT • Max.: 120 PSI

Item #	Type	
MIL-S-743	Female	\$30.05
MIL-S-744	Male	\$30.05



Universal Safety Exhaust Quick Connect Couplers
• Safely bleeds off air pressure before releasing connector
• Max.: 120 PSI

Item #	Type	NPT	Interchange Styles Accepted	
5 In ONE™ Universal Safety Exhaust Industrial Couplers				
MIL-S-1750	F	1/4" FNPT	M - V - T - A - L	\$38.35
MIL-S-1751	M	1/4" MNPT	M - V - T - A - L	\$38.35
MIL-S-1752	F	3/8" FNPT	M - V - T - A - L	\$41.05
MIL-S-1753	M	3/8" MNPT	M - V - T - A - L	\$41.05
2 In ONE™ Universal Safety Exhaust Industrial Couplers				
MIL-S-1756	F	1/4" FNPT x 3/8" Body Flow	H - P	\$50.75
MIL-S-1757	M	1/4" MNPT x 3/8" Body Flow	H - P	\$50.75
MIL-S-1758	F	3/8" FNPT x 3/8" Body Flow	H - P	\$54.85
MIL-S-1759	M	3/8" MNPT x 3/8" Body Flow	H - P	\$54.85
G-Style Universal Safety Exhaust Industrial Couplers				
MIL-S-1773	F	1/2" FNPT x 1/2" Body Flow	G-Style .125 G-Style .375	\$66.05
MIL-S-1774	M	1/2" MNPT x 1/2" Body Flow	G-Style .125 G-Style .375	\$66.05



High Flow Coupler and Plug Kits
• 1/4" NPT • Max.: 300 PSI

Item #	Contents	
LEG-A53452FZ	(1) FNPT Coupler, (1) FNPT Plug, (1) MNPT Plug	\$28.75
LEG-A53457FZ	(1) FNPT Coupler, (1) MNPT Coupler, (2) FNPT Plugs, (3) MNPT Plugs	\$58.25



AMT 3-Way Composite Couplers

• For use with A, M, and T-style fittings
• Inlet size: 1/4" NPT
• Max.: 210 PSI



Item #	Type	
TIT-19304	Female	\$16.55
TIT-19305	Male	\$14.75

Air Couplers & Plugs



Milton Plugs

• Max. inlet pressure: 300 PSI

Item #	Connection	Style	Air Flow	Material	Qty	
MALE Connection Plugs						
MIL-S-727	1/4" MNPT	M	40 SCFM	Steel	2	\$5.45
MIL-S-791	1/4" MNPT	L	32 SCFM	Steel	2	\$8.85
MIL-S-777	1/4" MNPT	A	34 SCFM	Steel	2	\$5.75
MIL-S-783	1/4" MNPT	T	40 SCFM	Steel	2	\$5.75
MIL-S-1839	1/4" MNPT	H	67 SCFM	Steel	2	\$9.75
MIL-S-1809	1/4" MNPT	P	68 SCFM	Steel	2	\$10.05
MIL-S-1837	3/8" MNPT	H	67 SCFM	Steel	2	\$10.95
MIL-S-1807	3/8" MNPT	P	68 SCFM	Steel	2	\$11.05
MIL-S-1817	1/2" MNPT	G	99 SCFM	Steel	1	\$8.35

FEMALE Connection Plugs						
MIL-S-728	1/4" FNPT	M	40 SCFM	Steel	2	\$5.65
MIL-S-778	1/4" FNPT	A	34 SCFM	Steel	2	\$6.05



Milton Couplers

• Max. inlet pressure: 300 PSI

Item #	Connection	Style	Air Flow	Material	Qty	
FEMALE Connection Couplers						
MIL-S-715	1/4" FNPT	M	40 SCFM	Brass	1	\$11.85
MIL-S-790	1/4" FNPT	L	32 SCFM	Steel	1	\$24.95
MIL-S-775	1/4" FNPT	A	34 SCFM	Steel	1	\$15.95
MIL-S-785	1/4" FNPT	T	40 SCFM	Brass	1	\$13.55
MIL-S-1833	1/4" FNPT	H	67 SCFM	Steel	1	\$26.55
MIL-S-1803	1/4" FNPT	P	68 SCFM	HD Steel	1	\$26.95
MIL-S-718	3/8" FNPT	M	40 SCFM	Brass	1	\$15.35
MIL-S-1835	3/8" FNPT	H	67 SCFM	Steel	1	\$27.05
MIL-S-1805	3/8" FNPT	P	68 SCFM	HD Steel	1	\$27.35
MIL-S-1815	1/2" FNPT	G	99 SCFM	Steel	1	\$33.35

MALE Connection Couplers						
MIL-S-716	1/4" MNPT	M	40 SCFM	Brass	1	\$11.85
MIL-S-776	1/4" MNPT	A	34 SCFM	Steel	1	\$17.75
MIL-S-719	3/8" MNPT	M	40 SCFM	Brass	1	\$15.35

Blow Guns

Pistol-Grip Air Blow Guns with Rubber Tips

• Includes 9/16", 15/16" & 1-3/8" rubber tips

Item #	Length	
ATD-8738	2-Pc Set: 4" & 13"	\$60.45
ATD-8737	4"	\$28.05
ATD-8735	13"	\$30.15
ATD-8736	20"	\$35.25



8738

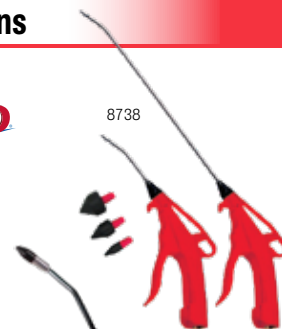

Deluxe Air Blow Guns with 1/2" Removable Rubber Tip

Item #	Length	Colour	
AST-1716	20"	Orange	\$20.65
AST-1715	13"	Green	\$18.55
AST-1717	4"	Green	\$14.65
AST-1718	4"	Orange	\$14.75



TIT-19391 **\$23⁶⁵**

4-Pc Air Blow Gun Set

• (1) 4" Air blow gun
• (3) Rubber tip nozzles: 9/16", 15/16", 1-3/8"



Turbo Blaster Blow Guns

• High volume of air flow
• 90-120 PSI working pressure



Item #	Nozzle	
SGT-99220	Standard	\$17.05
SGT-99230	6"	\$18.45



TIT-19475 **\$40⁷⁵**

4-in-1 Interchangeable Blow Gun Kit

Includes 4 attachments:

- 3-position fan tip
- Venturi tip boosts air flow 4 times
- 4.25" and 13" nozzles (can be assembled at 6 different angles)



8-Pc Air Blow Gun Set

• Includes 7 interchangeable tips
• Ideal for cleaning debris, drying off wet surfaces, inflating pool toys and balloons
• 160 PSI working air pressure



Blow Guns

LEG-AG1500FZKIT

\$78⁰⁵

Flexzilla™ X1™ Blow Gun Kit, 10-Piece

- 36 CFM
- 100 PSI



SGT-99680

\$44⁰⁵

Turbo Tornado Blow Gun

- Unique, tapered tip for a strong flow
- Lightweight and durable aluminum body
- Includes a 3/8" M NPT Industrial style fitting with a 1/4" body
- 42 SCFM at 125 PSI
- 25-230 PSI min/max



TOOL AID
PROFESSIONAL AUTOMOTIVE TOOLS



CHP-TYP-2500CS

\$40⁰⁵

Typhoon™ High Flow Blow Gun

- Variable trigger
- 34 CFM at 125 PSI
- Max. inlet pressure: 150 PSI
- 1/4" FNPT



COILHOSE
PNEUMATICS

TITAN



TIT-19378

\$10⁸⁵

Rubber Tipped Inline Blow Gun

- OAL: 1-1/2"



TIT-19435

\$12⁹⁵

Rubber Tipped Blow Gun

- Overall length: 4-3/4"



TIT-19996

\$15⁵⁵

Rubber Tipped Blow Gun

- 6" nozzle • OAL: 9"



MIL-S-148

\$19²⁵

Rubber Tip Lever Blow Gun

MILTON



MIL-S-150

\$27⁹⁵

Lever Style Blow Gun

- Full flow safety lever



MIL-S-115

\$14²⁵

M Style Adjustable Pocket Blow Gun

- Fits M style couplers or any 1/4" body industrial style couplers

MILTON

MIL-S-116

\$14³⁵

A Style Adjustable Pocket Blow Gun

- Fits A style couplers or any 1/4" body Aro 210 style coupler

LIS-88500

\$57⁰⁵

Radiator Genie® - Water & Air Cleaning Wands

- For high efficiency cooling systems, all types of radiators, and other hard-to-reach places
- Adjustable pressure and working width
- Interchangeable air fitting comes with M style connector, but can be used with any style



Lisle

LIS-88600

\$161⁷⁵

Radiator Genie® Industrial - 2-in-1 Water & Air Cleaning Wand

- For high efficiency cooling systems on large industrial equipment
- 50" extra-long wand for hard to reach places
- Adjustable pressure and working width
- Interchangeable air fitting comes with M style connector, but can be used with any style



LOC-886

\$131⁶⁵

Air-Powered Radiator Rocket - Coil and Line Cleaner

- Cleans cooling coils for radiators, transmission lines, oil and fuel lines
- Ideal for trailer truck, dump truck, earth moving, and tractor vehicles
- Can be configured in 3 foot, 2 foot, or 1 foot lengths eliminating need for vehicle jacks or lifts to access buried coils
- Broom with 4" air slot for maximum air cleaning volume and pressure
- Removable brush head for access to space constrained coils

LI
TOOLS

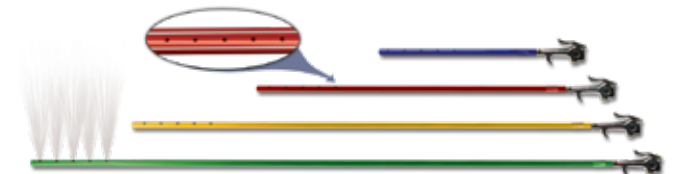

Air Comb® Filter and Radiator Cleaners

- Powerful 90° air flow
- Does not punch holes in air filters

FUTURE NOW™
IPA

Item #	Length	
IPA-8050	12"	\$46.55
IPA-8051	24"	\$52.85
IPA-8052	36"	\$68.05
IPA-8053	48"	\$74.35

IPA-8055

\$99⁵⁵

3-Pc Specialty Blow Gun Set

- 90° Blow gun (#8056)
- Air Scraper blow gun (#8057): combines air pressure and scouring action
- BlowBack™ gun (#8058): for cleaning head-bolt holes, manifolds and more



FUTURE NOW™
IPA



AIR COMPRESSORS & ACCESSORIES

Air Compressors



#GV3H-B80:
Shown with
optional wheel cart



Rotary Screw Air Compressors

- The Viper offers heavy-duty power, on or off your truck bed
- Diesel model features On/Off smart technology for fuel savings and noise reduction

Item #	Fuel	Cap. CFM	Air PSI	Engine RPM	HP	Fuel Cap.	Dim. L x W x H	Weight
GDL-GV3H-B80	Gas	80	100	3,600	25	10 Gal.	40" x 25" x 32"	440 lbs
GDL-050849	Diesel	80 (48 at idle)	100	3,600	25	9 Gal.	48" x 21" x 33"	735 lbs



Value Package – Two-Stage Electric-Powered Stationary Air Compressors



2545E10-V



2475N5-V
2475N7.5-V



Model	Item #	Motor	Tank Size	CFM @ 90PSI	Volts / Phase / Amps	L x W x H	Weight
2475N5-V	IRC-45465101	5 HP	80 Gal, Vertical	17.2 CFM	230V / 1 / 60A	28" x 38" x 69"	597 lbs
2475N5-V	IRC-45465135	5 HP	80 Gal, Vertical	17.2 CFM	230V / 3 / 60A	28" x 38" x 69"	597 lbs
2475N5-V	IRC-45465143	5 HP	80 Gal, Vertical	17.2 CFM	460V / 3 / 60A	28" x 38" x 69"	597 lbs
2475N7.5-V	IRC-45465408	7.5 HP	80 Gal, Vertical	24.3 CFM	230V / 1 / 60A	28" x 38" x 69"	611 lbs
2475N7.5-V	IRC-45465432	7.5 HP	80 Gal, Vertical	24.3 CFM	230V / 3 / 60A	28" x 38" x 69"	611 lbs
2475N7.5-V	IRC-45465440	7.5 HP	80 Gal, Vertical	24.3 CFM	460V / 3 / 60A	28" x 38" x 69"	611 lbs
2545E10-V	IRC-45465721	10 HP	120 Gal, Horizontal	35.6 CFM	230V / 3 / 60A	71" x 31" x 50"	900 lbs
2545E10-V	IRC-45465739	10 HP	120 Gal, Horizontal	35.6 CFM	460V / 3 / 60A	71" x 31" x 50"	900 lbs

BEP-AC072 \$303⁷⁵ 120V Single-Stage Commercial Portable Air Compressor

- Motor: 3/4 HP
- Tank Size: 2 Gallons
- Oil-Free Twin Pumps, Ultra Quiet
- 4.5A Amps
- Maximum PSI: 125
- CFM@ 90 PSI: 2.3 CFM
- 18" L x 15" W x 16" H
- Weight: 42 lbs
- 2-year warranty



60 Gallon Single-Stage Electric Driven Reciprocating Air compressors

	IRC-32334005	IRC-20103172
Model	SS3L3	SS5L5
Power	3 HP	5 HP
Flow at 90 PSI	11.3 CFM	18.1 CFM
Max. Pressure	135 PSI	135 PSI
Voltage/Engine	230V / 1 / 60A	230V / 1 / 60A
L x W x H	24" x 25" 67"	24" x 30" 73"
Weight	300 lbs	310 lbs



Air Compressors

MLW-2840-20 **\$478⁹⁵**
18V M18 Fuel™ 2-Gallon Compact Portable Quiet Air Compressor

- Quiet, 68 dBA
- Sits on PACKOUT™ lid
- Compatible with all M18™ battery packs
- Quick connect coupler fitting
- 1.2 CFM @ 90 PSI
- Max. 135 PSI
- 31.2 lbs



Milwaukee

BEP-67.000.700 **\$127¹⁵**
7 Gallon Portable Air Tank

- Pressure gauge
- Regulator protector
- Air filler chuck and hose
- Air bleed valve
- Roll over cage
- 17" L x 12" W x 14" H
- Weight: 20 lbs



BE
POWER EQUIPMENT

Portable Air Tanks

- Heavy gauge steel with rust-free finish
- Automatic pressure bypass with manual override
- Dual scale gauge: PSI and Mpa
- 85-125 PSI

Item #	Capacity	
TIT-19914	5 Gallon	\$112.95
TIT-19916	11 Gallon	\$171.65

VAPER™ TITAN



NEW

BE **INDUSTRIAL**
POWER EQUIPMENT

BEP-AC1330HEBG2S 
2-in-1 Combo Gas Compressor/Generator

- Dimensions: 48" x 31" x 58"
- Weight: 575 lbs
- Warranty: 3-year on engine, 2-year on pump

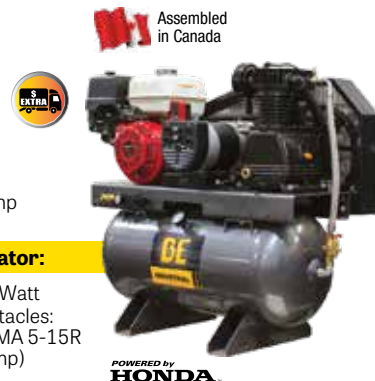

Assembled in Canada

30 Gallon Compressor:

- 13 HP Honda GX390 electric start engine
- 2 stage compressor
- 22 CFM @ 100 PSI
- 16 CFM @ 175 PSI

Generator:

- 4,000 Watt
- Receptacles: 4x NEMA 5-15R (20 Amp)

BE **INDUSTRIAL**
POWER EQUIPMENT

BEP-AC1330HB3000W 
3-in-1 Combo Gas Compressor/Generator/Welder

- No start-up kit required
- On-board battery mounted and wired (no truck wiring needed)
- Weight: 550 lbs • 46" L x 26" W x 42" H
- Warranty: 3-year on engine, 2-year on pump, 1-year on welder, 1-year on generator



Made in USA

30 Gallon Compressor:

- 390cc (13 HP) Honda engine with electric start
- 19 CFM @ 175 PSI
- Runs 1" drive impact wrenches
- Automatic tank drain

Generator:

- Peak: 5,500 Watt
- Running: 3,000 Watt
- 120/240V outlets
- 40 Amps @ 120 V
- 20 Amps @ 240 V

Stick/ARC Welder:

- 210 Amp

BE
POWER EQUIPMENT

Gas-Powered Air Compressors

- 3-year warranty on engine
- 2-year warranty on pump and tank



Assembled in Canada

AC658HB



Assembled in Canada



AC908HB2

AC1330HEB2



POWERED BY HONDA

Assembled in Canada

Item #	Series	Motor	Tank Size	Fuel Tank Capacity	Stage	Start System	CFM @ PSI	L x W x H	Weight	
BEP-AC658HB	Commercial	196cc GX200	8 Gallon	3.1 L	Single	Recoil	13.8 CFM @ 90 PSI 12.7 CFM @ 100 PSI	45" x 19" x 30"	175 lbs	\$1680.35
BEP-AC908HB2	Commercial	270cc GX270	8 Gallon	5.3 L	Two	Recoil	20.5 CFM @ 90 PSI 17.7 CFM @ 175 PSI	46" x 30" x 30"	280 lbs	
BEP-AC1330HEB2	Industrial	389cc GX390	30 Gallon	6.1 L	Two	Recoil & Electric	23 CFM @ 175 PSI	49" x 21" x 42"	485 lbs	

Air Filter/Regulator/Lubricator Units



Sub-Micronic Compressed Air Filters

- Removes up to .01 microns



Item #	NPT	Max. Flow	
MOT-M-30	1/4"	45 CFM	\$162.55
MOT-M-60	1/2"	100 CFM	\$162.55



MOT-M-723 **\$85⁵⁵**

Sub-Micronic Filter Element

- Removes to .01 microns
- Pack of 4 filters



ATD-7823 **\$147⁷⁵**

1/4" Polycarbonate General Purpose Filter

- Removes liquid, water, dirt and debris from air lines
- Max flow: 48 SCFM
- Filter element: 40 micron
- Bowl capacity: 5 oz
- Max. pressure: 150 PSI



Polycarbonate Micro Filters

- 150 PSI
- 48 SCFM
- 40 micron filter element

Item #	NPT	
MIL-1018	1/4"	\$112.45
MIL-1019	3/8"	\$113.05
MIL-1020	1/2"	\$115.25



High Pressure Regulators

- Regulated pressure range of 10-250 PSI

Item #	NPT	
MIL-1113-8	1/4"	\$121.35
MIL-1114-8	3/8"	\$121.35
MIL-1115-8	1/2"	\$150.25



Polycarbonate Lubricators

- 150 PSI
- Not for use with synthetic lubricants

Item #	NPT	
MIL-1028	1/4"	\$140.95
MIL-1029	3/8"	\$147.85
MIL-1030	1/2"	\$141.25



AST-2615 **\$73⁸⁵**

3/8" Filter/Regulator with Gauge

- 1/4" or 3/8" NPT, max. 135 PSI
- Air flow unit: 1,350 L/min (approx. 48 CFM)

AST-2618 **\$192⁷⁵**

1/2" Air Control Unit

- Air inlet/outlet: 1/2" NPT
- Filtration degree: 5µm
- Filter capacity: 120 CFM
- Regulator capacity: 50 CFM



ATD-7858 **\$298³⁵**

1/2" Filter/Regulator

- Max flow: 100 CFM
- Filter element: 40 micron
- Bowl capacity: 6 oz
- Max. pressure: 250 PSI
- Reduced press. outputs of 5-125 PSI



AST-2616 3/8" Filter, Regulator & Lubricator with Gauge

- 1/4" or 3/8" NPT with max. 135 PSI
- Air flow unit 1,350 L/min (approximately 47.655 CFM)
- 5µm micron filter



MOT-MHT-7000 **\$1168⁴⁵**

High Tech Air Preparation System

- Six stages of air prep in a single system
- Provides for the quickest, cleanest cartridge change in the industry
- Includes water, coalescer, activated carbon and desiccant filtration
- 1/2" NPT • 30 CFM • 125 PSI
- .01 micron filtration rating



ATD-6825 **\$125³⁵**

Digital Air Pressure Regulator

- Accurate measurement of air pressure to spray guns or other air tools
- Up to 160 PSI
- Units: PSI, BAR, KG/CM², KPA
- Automatic shut-off • 1/4" universal thread
- Battery-operated



Air Hoses



Flexzilla® Air Hose Assemblies

- All-weather flexibility (-40° to 140°F)
- Won't kink under pressure
- Lays flat – no memory
- Durable, abrasion-resistant outer cover



Item #	Length	Hose I.D.	Fittings	
LEG-HFZ1425YW2	25 feet	1/4"	1/4" MNPT	\$36.25
LEG-HFZ1450YW2	50 feet	1/4"	1/4" MNPT	\$55.85
LEG-HFZ14100YW2	100 feet	1/4"	1/4" MNPT	\$99.55
LEG-HFZ3825YW2	25 feet	3/8"	1/4" MNPT	\$48.55
LEG-HFZ3835YW2	35 feet	3/8"	1/4" MNPT	\$64.55
LEG-HFZ3850YW2	50 feet	3/8"	1/4" MNPT	\$65.15
LEG-HFZ38100YW2	100 feet	3/8"	1/4" MNPT	\$146.35
LEG-HFZ1225YW3	25 feet	1/2"	3/8" MNPT	\$72.15
LEG-HFZ1250YW3	50 feet	1/2"	3/8" MNPT	\$106.15
LEG-HFZ12100YW3	100 feet	1/2"	3/8" MNPT	\$223.85



Flexzilla® Pro Bulk Air Hose Spools

- Create custom length hose assemblies
- Flexzilla® Pro reusable ends sold separately



Item #	Spool Length	I.D.	
LEG-HFZ14250YW	250 feet	1/4"	\$224.45
LEG-HFZ38250YW	250 feet	3/8"	\$336.65
LEG-HFZ12250YW	250 feet	1/2"	\$420.25



Workforce® Rubber Air Hose Assemblies

- Medium oil-resistance tube
- Temp. range: -20° to 140°F



Item #	Length	Hose I.D.	Fittings	
LEG-HRE3825RD2	25 feet	3/8"	1/4" MNPT	\$50.95
LEG-HRE3850RD2	50 feet	3/8"	1/4" MNPT	\$89.05
LEG-HRE1225RD3	25 feet	1/2"	3/8" MNPT	\$96.65
LEG-HRE1250RD3	50 feet	1/2"	3/8" MNPT	\$141.45

Hybrid Polymer Air Hoses

- Superior cold weather flexibility
- Lays flat with no memory
- Oil, UV, weather and abrasion resistant cover
- Bend restrictors on hose ends
- 1/4" solid brass NPT end fittings
- Max. working pressure: 300 psi
- Max. burst pressure: 1,200 psi



Item #	Length	Hose I.D.	
ATD-18035	35 feet	3/8"	\$73.25
ATD-18050	50 feet	3/8"	\$97.95
ATD-18100	100 feet	3/8"	\$158.55



Ultra Lightweight Rubber Air Hoses

- Oil, abrasion and kink resistant
- Remains flexible in extreme conditions from -50°F to 190°F
- Working pressure: 300 psi
- Burst pressure: 1,200 psi
- 10 year limited warranty



Item #	Length	Hose I.D.	Fittings	
MIL-ULR142514	25 feet	1/4"	1/4" NPT	\$64.95
MIL-ULR382514	25 feet	3/8"	1/4" NPT	\$78.45
MIL-ULR382538	25 feet	3/8"	3/8" NPT	\$82.95
MIL-ULR122538	25 feet	1/2"	3/8" NPT	\$100.35
MIL-ULR122512	25 feet	1/2"	1/2" NPT	\$112.15
MIL-ULR383538	35 feet	3/8"	3/8" NPT	\$114.45
MIL-ULR145014	50 feet	1/4"	1/4" NPT	\$105.35
MIL-ULR385014	50 feet	3/8"	1/4" NPT	\$144.85
MIL-ULR385038	50 feet	3/8"	3/8" NPT	\$151.15
MIL-ULR125038	50 feet	1/2"	3/8" NPT	\$179.35
MIL-ULR125012	50 feet	1/2"	1/2" NPT	\$191.55
MIL-ULR3810038	100 feet	3/8"	3/8" NPT	\$294.05



Flexzilla® Whip Hose Assemblies

- Ball swivel male end
- Increases longevity of the main hose
- Increases mobility in tight spaces



Item #	Hose	Fittings	
LEG-HFZ3802YW2B	2 ft. x 3/8" I.D.	1/4" MNPT ball swiv. x 1/4" FNPT	\$22.05
LEG-HFZ3804YW2B	4 ft. x 3/8" I.D.	1/4" MNPT ball swiv. x 1/4" FNPT	\$23.95



LEG-LP1425AFZ \$55¹⁵ Flexzilla® Polyurethane Recoil Hose

- 25 ft. long x 1/4" hose I.D.
- All-weather flexibility (-40° to 165°F)
- Working pressure at 70°F: 120 psi
- 1/4" MNPT reusable ends



1/4" NPT Polyurethane Recoil Air Hoses

- Oil- and abrasion-proof
- Corrosion resistant
- 360° brass swivel fitting on air intake end



Item #	Hose Size	Working Pressure	
TOP-GF-562	1/4" x 25 feet	132 PSI @ 24°C	\$32.25
TOP-GF-563	1/4" x 50 feet	132 PSI @ 24°C	\$55.35
TOP-GF-564	3/8" x 25 feet	143 PSI @ 24°C	\$63.35
TOP-GF-565	3/8" x 50 feet	143 PSI @ 24°C	\$104.55

HOSES & ACCESSORIES

Air Hoses



Flexzilla® Enclosed Plastic Retractable Air Hose Reel

- Swivel mounting bracket, can be mounted to wall or ceiling
- Lead-in hose: 3 ft. x 1/4" MNPT



Flexzilla® Retractable Air Hose Reel with Levelwind™ Technology

- Lead-in hose: 5 ft. x 1/4" MNPT



Flexzilla® Retractable Air Hose Reel - Single Axle Arm Support

- Heavy-duty steel construction
- Lead-in hose: 5 ft. x 3/8" MNPT swivel x 1/4" MNPT



Flexzilla® Retractable Air Hose Reel - Dual Axle Arm Support

- Durable heavy-duty steel construction
- Lead-in hose: 5 ft. x 3/8" MNPT swivel x 3/8" MNPT

Item #	Hose I.D.	Length	Work Pressure	Temperature Range	Hose Outlet	Reel Inlet	
LEG-L8250FZ	3/8"	50 feet	150 psi	-40°F to 140°F	1/4" MNPT	1/4" MNPT	\$325.85
LEG-L8305FZ	3/8"	50 feet	300 psi	-40°F to 140°F	1/4" MNPT	3/4" x 11-1/2" GHT	\$475.15
LEG-L8611FZ	3/8"	50 feet	300 psi	-40°F to 140°F	3/8" MNPT	3/8" FNPT swivel	\$394.85
LEG-L8335FZ	1/2"	50 feet	300 psi	-40°F to 140°F	3/8" MNPT	3/4" x 11-1/2" GHT	\$531.25
LEG-L8741FZ	1/2"	50 feet	300 psi	-40°F to 140°F	3/8" MNPT	3/8" FNPT	\$935.65

Air/Water Hoses



Low Pressure Spring Retractable Air/Water Hose Reels

- PVC hose included

Item #	Features	Hose I.D. x Length	Max. Work Pressure	Max. Temp.	NPT(M) Hose Outlet	NPT(F) Reel Inlet	NPT(F) Reel Outlet	
Medium Duty								
RFT-RT650-OLP	Lightweight, Engineered Plastic Spool	3/8" x 50 ft.	300 psi	150°F (65°C)	1/4"	1/2"	1/4"	\$435.75
RFT-RT850-OLP	Lightweight, Engineered Plastic Spool	1/2" x 50 ft.	300 psi	150°F (65°C)	1/2"	1/2"	1/2"	\$586.55
Premium Duty								
RFT-4435 OLP	Compact	1/4" x 35 ft.	300 psi	150°F (65°C)	1/4"	3/8"	1/4"	\$394.85
RFT-4625 OLP	Compact	3/8" x 25 ft.	300 psi	150°F (65°C)	1/4"	3/8"	1/4"	\$407.45
RFT-5650 OLP	Compact	3/8" x 50 ft.	300 psi	150°F (65°C)	1/4"	3/8"	1/4"	\$565.55
RFT-A5850 OLP	Compact	1/2" x 50 ft.	300 psi	150°F (65°C)	1/2"	3/8"	1/2"	\$632.65
Heavy Duty								
RFT-7650 OLP	Dual Pedestal Base	3/8" x 50 ft.	300 psi	150°F (65°C)	1/4"	1/2"	1/2"	\$703.85
RFT-7850 OLP	Dual Pedestal Base	1/2" x 50 ft.	300 psi	150°F (65°C)	3/8"	1/2"	1/2"	\$727.95
RFT-82100 OLP	Dual Pedestal Base	1/2" x 100 ft.	300 psi	150°F (65°C)	1/2"	1/2"	1/2"	\$1151.05
RFT-83050 OLP	Dual Pedestal Base	3/4" x 50 ft.	250 psi	150°F (65°C)	3/4"	3/4"	3/4"	\$1106.05

Air/Water Hoses

Hose Reels for Air & Water

- Heavy-gauge, all steel construction
- Heavy-duty rubber air hoses

Item #	Hose Size	Inlet NPT	Outlet NPT	Max. Press.	Max. Air Flow	
LIN-83753	3/8" x 50 ft.	1/4" (F)	1/4" (M)	300 psi	25 cfm	\$323.25
ATD-31166	3/8" x 50 ft.	1/4" (F)	1/4" (M)	300 psi	25 cfm	\$189.95
LIN-83754	1/2" x 50 ft.	1/2" (F)	1/2" (M)	300 psi	35 cfm	\$348.55
ATD-31167	1/2" x 50 ft.	1/2" (F)	1/2" (M)	300 psi	35 cfm	\$249.95



Low Pressure Spring Retractable Hose Reels for Air/Water

- Hose not included

	RFT-7800 OLP	RFT-83000 OLP
Duty	Premium Duty	Ultimate Duty • Dual Pedestal Base
Hose Length	50 ft.	50 ft.
Hose I.D.	1/2"	3/4"
Hose O.D.	0.75"	1.075"
Max. Pressure	500 psi	500 psi
Max. Temp.	210°F (99°C)	210°F (99°C)
Reel Inlet NPT(F)	1/2"	3/4"
Reel Outlet NPT(F)	1/2"	3/4"
	\$621.05	\$1027.45

REELCRAFT®

Made in USA



REELCRAFT®

Made in USA



CA32106 L
CA33106 L



CA32112 L
CA33112 L



CH37118 L

Hand Crank Hose Reels for Air/Water

- Designed for rugged, heavy-duty applications requiring long lengths of hose and large storage capacity
- Full flow swivel, and heavy gauge steel frame, spool, and drum
- Vibration-proof, self-locking fasteners
- T-handle tensioning device allows proper tension to be applied to the spool to eliminate the free spooling of the reel
- Hose not included

Item #	Hose I.D.	Hose Length	Hose O.D.	Reel Inlet NPT (F)	Reel Outlet NPT (F)	Max. Pressure	Max. Temperature	
RFT-CU6050LN	3/8"	50 ft.	0.6"	3/8"	3/8"	300 psi	150°F (65°C)	\$167.95
RFT-CU6100LN	3/8"	100 ft.	0.6"	3/8"	3/8"	300 psi	150°F (65°C)	\$210.55
RFT-CT6100HN	3/8"	100 ft.	0.73"	1/2"	3/8"	5000 psi	212°F (100°C)	\$290.15
RFT-CA32106 L	1/2"	100 ft.	0.85"	1/2"	1/2"	1000 psi	210°F (99°C)	\$410.55
RFT-CA32112 L	1/2"	200 ft.	0.75"	1/2"	1/2"	1000 psi	210°F (99°C)	\$418.95
RFT-CA33106 L	3/4"	50 ft.	1.075"	3/4"	3/4"	1000 psi	210°F (99°C)	\$554.05
RFT-CA33112 L	3/4"	100 ft.	1.075"	3/4"	3/4"	1000 psi	210°F (99°C)	\$554.05
RFT-CH37118 L	1"	100 ft.	1.375"	1"	1"	1000 psi	210°F (99°C)	\$803.35

HOSES & ACCESSORIES

Water Hoses



Flexzilla® Garden Hose Assemblies

- Extreme all-weather flexibility
- Won't kink under pressure
- Lightweight, coils easily
- Lays flat - no memory



Item #	Length	Hose I.D.	Fittings	
LEG-HFZG550YW	50 feet	5/8"	3/4" x 11-1/2" GHT	\$85.55
LEG-HFZG5100YW	100 feet	5/8"	3/4" x 11-1/2" GHT	\$163.05

Flexzilla® Pro Water Hose Assemblies with Reusable Fittings

- Extreme all-weather flexibility
- Field repairable – reusable fittings
- Won't kink under pressure
- Lays flat – no memory
- Max. working pressure at 70°F: 150 psi
- Drinking water safe



Item #	Length	Hose I.D.	Fittings	
LEG-HFZWP550	50 feet	5/8"	3/4" x 11-1/2" GHT	\$124.95
LEG-HFZWP575	75 feet	5/8"	3/4" x 11-1/2" GHT	\$171.85
LEG-HFZWP5100	100 feet	5/8"	3/4" x 11-1/2" GHT	\$218.75

LEG-HFZW58250YW **\$493⁶⁵**

Flexzilla® Pro Bulk Water Hose Spool

- 5/8" I.D. x 250 ft. hose
- Fittings sold separately
- Hose is drinking water safe



LEG-HFZG12050QN **\$74⁴⁵**

Flexzilla® Garden Hose Kit with Quick Connect Attachments

- 1/2" I.D. x 50 ft. hose
- 3/4" x 11-1/2" GHT fittings
- Max. working pressure: 150 psi
- Kit includes: Flexzilla® garden hose with quick-connect couplers, hose hanger, nozzle, adapter for spigot, (2) garden hose attachment adapters



Flexon™ Heavy Duty Water Hoses

- Knitted radial reinforcement
- Tough, weather-resistant vinyl cover
- Excellent handling, even in cold weather
- Solid crush-proof couplings



Item #	I.D. x Length	
FXN-FXG5850	5/8" x 50 feet	\$73.75
FXN-FXG5875	5/8" x 75 feet	\$104.35

Hose Fittings



Flexzilla® Pro AIR Hose Reusable Fittings

Item #	Size	
LEG-RP900250	1/4"	\$6.45
LEG-RP900375	3/8"	\$8.85
LEG-RP900500	1/2"	\$10.85



Flexzilla® Pro WATER Hose Reusable Fittings

Item #	Size	
LEG-RP900625F	5/8" F	\$17.65
LEG-RP900625M	5/8" M	\$14.45

Hose Nozzles

ATD-9101 **\$35⁶⁵**

Adjustable Spray Hose Nozzle

- Nozzle made of heavy duty brass
- Will not corrode
- Rubber insulation and grip
- Adjustable from gentle fan to powerful jet stream



TIT-11091 **\$30⁵⁵**

Adjustable Spray Hose Nozzle

- Attaches to any garden hose
- Variable water streams
- Durable rubber material



Flexzilla® Pro Water Hose Nozzles

- Multiple spray patterns
- Works with 1/2", 5/8" and 3/4" water hoses

Item #	
LEG-NFZG01-N	\$87.15
LEG-NFZG02-N	\$102.65



NFZG02-N



NFZG01-N

Air Hose Holders

Air Hose Holders

- For use with most 3/8" to 1/2" shop air hoses
- Magnet or screw mountable

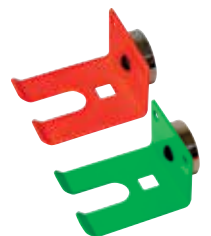

Item #	Colour	
LIS-49700	Red	\$26.65
LIS-49750	Green	\$26.65

Reciprocating Saw Blades



49-22-3306



49-22-3305



49-22-3316

Milwaukee



SAWZALL® Reciprocating Saw Blades

Item #	Application	Length	TPI	Qty	
MLW-48-00-5092	Thick Metal	6"	10	5	\$17.75
MLW-48-00-5184	Medium Metal	6"	18	5	\$17.75
MLW-48-00-5093	Multi-Material	8"	8/12	5	\$22.75
MLW-48-00-5187	Medium Metal	9"	14	5	\$21.65
MLW-48-00-5188	Medium Metal	9"	18	5	\$21.65
MLW-48-00-5189	Rigid Conduit/ Strut	12"	18	5	\$27.15



SAWZALL® TORCH™ & NITRUS TORCH™ Reciprocating Saw Blades with Carbide Teeth

Item #	Application	Length	TPI	Qty	
MLW-48-00-5501	Thick Metal, S/S	6"	7	5	\$77.25
MLW-48-00-5502	Thick Metal, S/S	9"	7	5	\$94.45
MLW-48-00-5503	Thick Metal, S/S	12"	7	5	\$138.55
MLW-48-00-5263	Cast Iron, Thick Metal, S/S	12"	7	1	\$39.75
MLW-48-00-5363	Cast Iron, Thick Metal, S/S	12"	7	3	\$116.95
MLW-48-00-5563	Cast Iron, Thick Metal, S/S	12"	7	5	\$171.35

MLW-49-22-3306 **\$86⁷⁵**

5-Pc SAWZALL® Carbide Demolition Wood and Metal Cutting Reciprocating Saw Blade Set

- (2) 9" 5 TPI – THE AX™ Sawzall® blades
- (1) 9" 7 TPI – THE TORCH™ Sawzall® blade
- (2) 6" 7 TPI – THE TORCH™ Sawzall® blades

MLW-49-22-3305 **\$25⁵⁵**

5-Pc SAWZALL® Demolition Blade Set

- (1) 6" 14 TPI – THE TORCH™ metal cutting demolition blade
- (1) 6" 18 TPI – THE TORCH™ metal cutting demolition blade
- (1) 9" 14 TPI – THE TORCH™ metal cutting demolition blade
- (1) 9" 5 TPI – THE AX™ wood cutting blade
- (1) 9" 7/11 TPI – THE WRECKER™ multi-material blade

MLW-49-22-3316 **\$42⁵⁵**

16-Pc SAWZALL® Metal Cutting Bi-Metal Reciprocating Blade Set

- (2) 9" 14 TPI and (2) 18 TPI – THE TORCH™ metal cutting demolition blades
- (2) 9" 18 TPI – Standard metal cutting blades
- (2) 6" 14 TPI and (2) 18 TPI – THE TORCH™ metal cutting demolition blades
- (3) 6" 18 TPI and (3) 24 TPI – Standard metal cutting blades

Reciprocating Saw Blades

LENOX

Item #	L x W x Th.	TPI	Qty	Application	
A LAZER® BI-METAL BLADES					
LEN-201726114R	6" x 1" x .035"	14	5	Structural steels and all metals	\$34.55
LEN-201746118R	6" x 1" x .035"	18	5	Structural steels and all metals	\$34.55
B AIR SAW BLADES					
LEN-20426418T	4" x 1/2" x .025"	18	5	Automotive repair & sheet metal	\$25.95
LEN-20427424T	4" x 1/2" x .025"	24	5	Automotive repair & sheet metal	\$25.95
LEN-20428432T	4" x 1/2" x .025"	32	5	Automotive repair & sheet metal	\$25.95
C METAL CUTTING SAW BLADES					
LEN-20564614R	6" x 3/4" x .035"	14	5	Thick & medium metal	\$24.35
LEN-21519814R	8" x 3/4" x .035"	14	5	Thick & medium metal	\$27.15
LEN-20578818R	8" x 3/4" x .035"	18	5	Medium & thin metal	\$30.85
D GENERAL PURPOSE BI-METAL SAW BLADES					
LEN-20580810R	8" x 3/4" x .050"	10	5	Plastics, wood, medium metal	\$30.85



LENOX

LEN-1073415RKG **\$77⁸⁵**

15-Pc General Purpose Reciprocating Saw Blade Kit

- (5) 6" x 3/4" x .035" blades, 14 TPI
- (5) 6" x 3/4" x .035" blades, 18 TPI
- (5) 6" x 3/4" x .050" blades, 6 TPI

SAW BLADES & SAWS

Jig Saw Blades



48-42-2190



48-42-5310



48-42-5540



48-42-5161



T-Shank



U-Shank

Jig Saw Blades

- Sold in packs of 5 blades

Item #	Length	TPI	Shank	Application	
GENERAL PURPOSE					
MLW-48-42-5300	4"	6	T-Shank	Fast cutting, nail embedded wood	\$15.95
MLW-48-42-5310	4"	10	T-Shank	Fast cutting, nail embedded wood	\$15.95
WOOD CUTTING					
MLW-48-42-5311	4"	10	T-Shank	Fast clean cutting	\$20.45
MLW-48-42-5540	4"	10	T-Shank	Reverse tooth, no top splinters	\$16.35
METAL CUTTING					
MLW-48-42-5850	4"	8	T-Shank	Aluminum, non-ferrous metals	\$18.05
MLW-48-42-5192	5-1/4"	14	T-Shank	Thick metal, tubing, etc.	\$22.25
MLW-48-42-5121	3"	18	T-Shank	Metal over 1/8" thick	\$14.25
MLW-48-42-5161	3"	24	T-Shank	Metal under 1/8" thick	\$14.25
MLW-48-42-5166	5-1/4"	24	T-Shank	Thin metal under 1/8" thick	\$18.35
MLW-48-42-2190	3-5/8"	14	U-Shank	Thick metal over 1/4" thick	\$14.95

Hacksaw Blades



LEN-12132HT50 **\$48³⁵**

High Tension Hacksaw

- Up to 50,000 psi tension
- Stores up to 5 extra 12" hacksaw blades
- Comes with one 12" (300mm) 24 TPI hacksaw blade



Shatter-Resistant Hacksaw Blades



Item #	L x W	TPI	Qty	Application	
LEN-20117224HE	12" x 1/2"	24	100	Medium metal	\$301.15
LEN-20144V218HE	12" x 1/2"	18	10	Heavy metal	\$31.95
LEN-20145V224HE	12" x 1/2"	24	10	Medium metal	\$31.95
LEN-20146V232HE	12" x 1/2"	32	10	Thin metal	\$31.95

Circular Saw Blades



LENOX® METALMAX™ Diamond Edge Circular Saw Blades

Item #	Diam.	Thickness	Arbor	Application	
LEN-1972923	6"	.050"	7/8"	Angle Grinder/Circular Saw	\$48.25
LEN-1972929	14"	.130"	1"	Chop Saw	\$191.05

Hole Saws



HOLE DOZER™ Bi-Metal Hole Saw Kits

- 3.5 TPI bi-metal tooth design



Item #	Content	Hole Saw Size Range	
MLW-49-22-4083	7-Piece	3/4" - 1-1/4"	\$65.45
MLW-49-22-4084	11-Piece	3/4" - 2-1/2"	\$90.25
MLW-49-22-4175	15-Piece	3/4" - 2-1/2"	\$186.15 <small>\$ While Q'tys. Last</small>
MLW-49-22-4170	20-Piece	3/4" - 4-1/2"	\$268.55
MLW-49-22-4171	21-Piece	3/4" - 5"	\$278.85
MLW-49-22-4185	28-Piece	3/4" - 4-3/4"	\$443.15 <small>\$ While Q'tys. Last</small>



IRW-3073004 **\$182²⁵**

17-Pc General Purpose Bi-Metal Hole Saw Kit

- 5/8" - 3"



308042000G

Contractor's Speed Slot® Hole Saw Kits

Item #	Description	
LEN-308201200G	17-Piece: 5/8" - 3"	\$306.25
LEN-308042000G	26-Piece: 3/4" - 4-3/4"	\$732.95



Wire Brushes



Standard TWIST KNOT Wire Wheels

Item #	Diameter	Face Width	Arbor Hole	Fill Diam.	Max. RPM	
WEI-08004	3"	3/8"	1/2"-3/8"	0.0118"	25,000	\$39.45
WEI-08014	3"	3/8"	1/2"-3/8"	0.014"	25,000	\$37.95
WEI-08024	3"	3/8"	1/2"-3/8"	0.020"	25,000	\$36.65
WEI-08044	4"	1/2"	1/2"-3/8"	0.014"	20,000	\$41.85
WEI-08064	4"	1/2"	1/2"-3/8"	0.020"	20,000	\$41.25
WEI-08075	6"	1/2"	5/8"-1/2"	0.0118"	9,000	\$69.85
WEI-08135	8"	5/8"	5/8"	0.014"	6,000	\$102.35



CRIMPED Wire Wheel

Item #	Diameter	Face Width	Arbor Hole	Fill Diam.	Max. RPM	
WEI-01505	6"	3/4"	5/8"-1/2"	0.014"	6,000	\$61.35



Stem-Mounted KNOTTED Wire Wheels

Item #	Diameter	Face Width	Stem Size	Fill Diam.	Max. RPM	
WEI-17681	3-1/4"	3/8"	1/4"	0.014"	25,000	\$44.95
WEI-17682	3-1/4"	3/8"	1/4"	0.020"	25,000	\$43.55



Single Row KNOTTED Wire Cup Brushes

Item #	Diameter	Thread. Hole	Fill Diam.	Max. RPM	
WEI-13025	2-3/4"	5/8"-11 UNC	0.014"	14,000	\$42.15
WEI-12306	4"	5/8"-11 UNC	0.014"	10,200	\$66.75



CRIMPED Wire Cup Brushes

Item #	Diameter	Thread. Hole	Fill Diam.	Max. RPM	
WEI-36231	3"	5/8"-11 UNC	0.014"	14,000	\$27.65
WEI-14206	5"	5/8"-11 UNC	0.014"	9,000	\$74.85
WEI-14216	5"	5/8"-11 UNC	0.020"	9,000	\$69.65



VORTEC PRO® KNOTTED Wire End Brushes

Item #	Diameter	Fill Diam.	Stem Size	Max. RPM	
WEI-36286	3/4"	0.014"	1/4"	22,000	\$18.15
WEI-36250	3/4"	0.020"	1/4"	22,000	\$18.05
WEI-36288	1"	0.014"	1/4"	22,000	\$18.85
WEI-36251	1"	0.020"	1/4"	22,000	\$18.55



CRIMPED Wire End Brushes

Item #	Diameter	Fill Diam.	Stem Size	Max. RPM	
WEI-10008	3/4"	.020"	1/4"	22,000	\$17.15
WEI-10012	1"	.020"	1/4"	22,000	\$18.45



Circular Flared CRIMPED End Brush

Item #	Diameter	Fill Diam.	Stem Size	Max. RPM	
WEI-10035	1-1/4"	0.008"	1/4"	20,000	\$29.35



CRIMPED Wire End Brushes

Item #	Diameter	Fill Diam.	Stem Size	Max. RPM	
WEI-36246	3/4"	0.014"	1/4"	22,000	\$10.25
WEI-36248	1"	0.014"	1/4"	22,000	\$12.25



Power Tube Brushes

Item #	Brush Diam.	Brush Length	Fill Diam.	Stem Size	Max. RPM	
WEI-21106	1/2"	2"	0.004"	1/8"	2,000	\$20.15
WEI-21107	1/2"	2"	0.006"	1/8"	2,000	\$19.35
WEI-21108	5/8"	2"	0.005"	3/16"	2,000	\$21.15
WEI-21109	5/8"	2"	0.008"	3/16"	2,000	\$19.75
WEI-21110	3/4"	2-1/2"	0.006"	1/4"	2,000	\$20.85
WEI-21111	3/4"	2-1/2"	0.0104"	1/4"	2,000	\$20.05
WEI-21112	7/8"	2-1/2"	0.006"	1/4"	2,000	\$22.15
WEI-21114	1"	2-1/2"	0.006"	1/4"	2,000	\$22.55

Wire Brushes



Mandrel Mounted Copper Center Wheel Brushes



Item #	Diameter	Fill Diam.	Face Width	Max. RPM	
BRM-BMC2010	2"	.0104	5/16"	25,000	\$18.25
BRM-BMC2510	2-1/2"	.0104	5/16"	25,000	\$18.75
BRM-BMC3010	3"	.0104	5/16"	25,000	\$18.75



Light-Duty Wire Cup Brush

- Removes light scale, rust and paint from surfaces



Item #	Diameter	Fill Diam.	Stem Size	Max. RPM	
GWR-2314D	2-1/2"	0.014"	1/4"	5,000	\$16.25

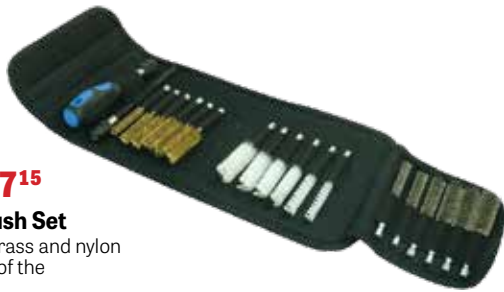

AST-9020 **\$37¹⁵** 20-Pc Wire Brush Set

- Stainless steel, brass and nylon brushes in each of the following sizes: 1/4", 3/8", 1/2", 5/8", 3/4", 1"



ATD-8320 **\$47⁸⁵** 20-Pc Twisted Wire Tube Brush Set

- Stainless steel, brass and nylon brushes in each of the following sizes: 1/4", 3/8", 1/2", 5/8", 3/4", 1"
- Can be used manually or with a drill/driver



IPA-8090S **\$219⁹⁵**

Professional Diesel Injector-Seat Cleaning Kit

- For most diesel applications
- Specially designed to clean diesel injector-seats and bores on most light, medium, and heavy-duty diesel motors
- Kit includes Helix brushes, two-stage brushes, bore brushes and SWAB-EEZ[®]



IPA-8001D **\$126⁰⁵**

The Original 36-Pc Bore Brush Set

- The kit contains 8-19mm brushes in stainless steel, brass and nylon and a 1/4" locking bit head driver
- Cleans bushings, tubes, holes, channels, sockets, brake guides and more!
- Replacement brushes available in packs of 3



IPA-8080 **\$18⁸⁵**

6-Pc Stainless Steel Bore Brush Set

- 8, 10, 12, 15, 17 and 19mm sizes, 1/4" hex drive



4-Piece 9" Long Bore Brush Sets

- 10, 15, and 19mm sizes
- 1/4" standard driver handle

Item #	Bristles	
IPA-8083	Stainless Steel	\$41.55
IPA-8084	Brass	\$42.75



IPA-8037 **\$47⁸⁵**

4-Pc Extra Large Stainless Steel Bore Brush Set

- Clean brake calipers, throttle bodies, fittings and more!
- 25, 30, 35 and 40mm diameters, 1/4" hex drive, 3.5" long



Scratch Brushes



Scratch Brushes

Item #	Description	Overall Length	Fill	
BRM-93APB	Tooth Brush	7-1/4"	Brass	\$3.75
BRM-93APN	Tooth Brush	7-1/4"	Nylon	\$3.75
BRM-93APP	Tooth Brush	7-1/4"	Bronze	\$3.75
BRM-B39B	Curved Handle Brush	13-3/4"	Brass	\$16.95
BRM-B740SS	Curved Handle Brush	13-3/4"	Stainless Steel	\$14.15



WEI-44053 **\$5¹⁵**
14" Steel Wire Scratch Brush

- Block width: 7/8"
- Steel fill: 0.012", 3 x 19 rows

WEI-44064 **\$11⁵⁵**
10" S/S Wire Scratch Brush

- Block width: 1-1/8"
- Stainless steel fill: 0.012", 4 x 16 rows

WEI-44077 **\$13⁹⁵**
13" Nylon Plater's Brush

- Block width: 1-1/8"
- Nylon fill: 0.014", 4 x 18 rows

WEI-44118 **\$16¹⁵**
13" Brass Plater's Brush

- Block width: 7/8"
- Brass fill: 0.006", 3 x 19 rows

TIT-41308 **\$13²⁵**
8-1/4" Curved Utility Brush

- 24 rows of carbon steel bristles
- Brush length: 1-1/4"



Flex-Hones®



Small Diameter Standard Duty Flex-Hones®

- Resilient, flexible honing tools for any type and size of cylinder
- 180 grit, silicon carbide abrasive
- 8" overall length

Item #	Diameter	
BRM-BC1218	1/2" (12.7mm)	\$26.15
BRM-BC5818	5/8" (16mm)	\$27.75
BRM-BC3418	3/4" (19mm)	\$29.25
BRM-BC7818	7/8" (22mm)	\$29.45
BRM-BC10018	1" (25.4mm)	\$31.55
BRM-BC11818	1-1/8" (29mm)	\$33.15
BRM-BC11418	1-1/4" (31.8mm)	\$35.75
BRM-BC13818	1-3/8" (35mm)	\$36.65
BRM-BC11218	1-1/2" (38mm)	\$39.45
BRM-BC15818	1-5/8" (41mm)	\$39.45
BRM-BC13418	1-3/4" (45mm)	\$41.15
BRM-BC20018	2" (51mm)	\$42.65
BRM-BC21418	2-1/4" (57mm)	\$46.25
BRM-BC21218	2-1/2" (64mm)	\$49.75
BRM-BC23418	2-3/4" (70mm)	\$54.95
BRM-BC30018	3" (76mm)	\$63.75

Item #	Diameter	
BRM-BC5M18	5mm	\$28.65
BRM-BC55M18	5.5mm	\$29.15
BRM-BC64M18	6.4mm	\$19.95
BRM-BC7M18	7mm	\$20.25
BRM-BC8M18	8mm	\$21.15
BRM-BC9M18	9mm	\$22.05
BRM-BC95M18	9.5mm	\$24.35
BRM-BC10M18	10mm	\$24.55
BRM-BC11M18	11mm	\$25.15
BRM-BC12M18	12mm	\$25.65
BRM-BC14M18	14mm	\$26.25
BRM-BC18M18	18mm	\$28.55
BRM-BC20M18	20mm	\$29.35



Heavy Duty Flex-Hones®

- 120 grit, silicon carbide abrasive
- 3" thru 4-1/2" are 13-1/2" OAL
- 5" thru 8" are 17-1/2" OAL

Item #	Diameter	For Bore Sizes	
BRM-GBD30012	3" (76mm)	3" - 2-3/4"	\$104.25
BRM-GBD31412	3-1/4" (83mm)	3-1/4" - 3"	\$107.55
BRM-GBD31212	3-1/2" (89mm)	3-1/2" - 3-1/4"	\$110.75
BRM-GBD33412	3-3/4" (95mm)	3-3/4" - 3-1/2"	\$118.75
BRM-GBD40012	4" (101mm)	4" - 3-3/4"	\$126.75
BRM-GBD41412	4-1/4" (108mm)	4-1/4" - 4"	\$135.45
BRM-GBD41212	4-1/2" (114mm)	4-1/2" - 4-1/4"	\$144.25
BRM-GBD50012	5" (127mm)	5" - 4-1/2"	\$164.05
BRM-GBD51212	5-1/2" (140mm)	5-1/2" - 5"	\$179.95
BRM-GBD60012	6" (152mm)	6" - 5-1/2"	\$194.95
BRM-GBD61212	6-1/2" (165mm)	6-1/2" - 6"	\$207.25
BRM-GBD70012	7" (178mm)	7" - 6-1/2"	\$225.95
BRM-GBD71212	7-1/2" (190mm)	7-1/2" - 7"	\$248.55
BRM-GBD80012	8" (203mm)	8" - 7-1/2"	\$271.55

ABRASIVES, CUTTING & GRINDING ACCESSORIES

Engine Cylinder Hones

GEARWRENCH

GWR-2833D **\$44⁶⁵**

Engine Cylinder Hone

- Hone and remove glaze from engine cylinders from 2" to 7" (51 to 177mm) in diameter
- Hone includes medium grit stones - grit No. 240



Lisle

LIS-23500 **\$52⁶⁵**

Stone-Type Glaze Breaker

- Two range settings: 2" to 4" and 4" to 7"
- Replacement stones available: #23520, #23530, #23540



15000



Lisle

16000



Engine Cylinder Hones

- Replacement stones available: #15500, #15690, #15510, #15520

Item #	Cylinder Size Range	
LIS-16000	1-3/4" to 2-3/4"	\$409.85
LIS-15000	3" to 4-1/4"	\$379.45

Deburring Tools

FOW-72-483-777-0 **\$27⁵⁵**

4-Pc Deburring Cutter Set

- Curved blades swivel freely to automatically follow shapes, contours and holes
- Colour coded cutters for use with aluminum, brass, steel and plastic



FOW-72-483-888-0 **\$79²⁵**

Universal Deburring, Cleaning & Countersink Set

Set includes:

- 1 universal handle
- 2 adapters
- 2 deburring blades
- 1 countersink for 20mm/0.47" diameter
- 1 countersink for 30mm/1.18" diameter
- 4 cleaner blades, for sheet metal, small ridges, relieving corners and for narrow slots



Fowler

Deburring Tools

TITAN

51951



51950



Exo Burr™ External Deburrers

- Quickly repairs damaged threads on steel bolts including stainless steel and hardened steel, threaded rod, copper, brass, aluminum, plastics, and wood
- Works with most power drills

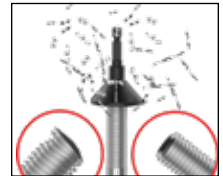

Item #	Material Size Range	
TIT-51951	5/32" to 7/16" (4mm-12 mm)	\$76.25
TIT-51950	5/16" to 7/8" (8mm-22 mm)	\$92.95

CTA-3838 **\$80³⁵**

E-Z Chamfer® Deburring Tool

- Efficiently removes burrs and ridges from bolts, pipe, threaded rod, bar and dowels
- Threads and burrs are sheared off creating the perfect chamfer for starting a nut or threading die
- Works with most power drills on materials ranging from 5/16" to 7/8" (8-22 mm)



ATA

Burrs

MasterCut Made in USA

NX Series Burrs for Stainless Steel, 1/4" Shank



Item #	Shape	Diam.	OAL	
MST-SA-3NX	Cylindrical, no End Cut	3/8"	2-1/2"	\$32.95
MST-SA-5NX	Cylindrical, no End Cut	1/2"	2-3/4"	\$51.75
MST-SC-3NX	Radius Cylindrical	3/8"	2-1/2"	\$36.65
MST-SC-5NX	Radius Cylindrical	1/2"	2-3/4"	\$57.55
MST-SD-3NX	Ball	3/8"	2-1/8"	\$31.95
MST-SD-5NX	Ball	1/2"	2-1/4"	\$41.85
MST-SE-3NX	Oval	3/8"	2-3/8"	\$40.45
MST-SE-5NX	Oval	1/2"	2-5/8"	\$57.55
MST-SF-3NX	Radius Tree	3/8"	2-1/2"	\$37.75
MST-SF-5NX	Radius Tree	1/2"	2-3/4"	\$53.45
MST-SG-3NX	Pointed Tree	3/8"	2-1/2"	\$37.75
MST-SG-5NX	Pointed Tree	1/2"	2-3/4"	\$53.45
MST-SH-2NX	Flame	5/16"	2-1/2"	\$36.65
MST-SH-5NX	Flame	1/2"	3"	\$75.35
MST-SL-3NX	Radius Cone	3/8"	2-13/16"	\$45.55
MST-SL-4NX	Radius Cone	1/2"	3-1/64"	\$58.15

ABRASIVES, CUTTING & GRINDING ACCESSORIES

Burrs



Mastercut
Individual Burrs,
1/4" Shank



Made in USA

Doublecut



Alumacut

	Item #	Shape	Diam.	Cut Type	OAL	
	MST-SB-1DC	Cylindrical with End Cut	1/4"	Doublecut	2"	\$19.95
	MST-SB-3DC	Cylindrical with End Cut	3/8"	Doublecut	2-1/2"	\$27.55
	MST-SB-3FM	Cylindrical with End Cut	3/8"	Alumacut	2-1/2"	\$35.55
	MST-SB-3L6DC	Cylindrical with End Cut	3/8"	Doublecut	6-3/4"	\$42.75
	MST-SB-5DC	Cylindrical with End Cut	1/2"	Doublecut	2-3/4"	\$43.95
	MST-SB-5FM	Cylindrical with End Cut	1/2"	Alumacut	2-3/4"	\$56.45
	MST-SB-5L6DC	Cylindrical with End Cut	1/2"	Doublecut	7"	\$59.15
	MST-SC-1DC	Radius Cylindrical	1/4"	Doublecut	2"	\$21.15
	MST-SC-3DC	Radius Cylindrical	3/8"	Doublecut	2-1/2"	\$27.95
	MST-SC-3L6DC	Radius Cylindrical	3/8"	Doublecut	6-3/4"	\$43.15
	MST-SC-5DC	Radius Cylindrical	1/2"	Doublecut	2-3/4"	\$43.95
	MST-SC-5FM	Radius Cylindrical	1/2"	Alumacut	2-3/4"	\$56.45
	MST-SC-5L6DC	Radius Cylindrical	1/2"	Doublecut	7"	\$59.15
	MST-SD-1DC	Ball	1/4"	Doublecut	2"	\$20.35
	MST-SD-3DC	Ball	3/8"	Doublecut	2-1/8"	\$24.95
	MST-SD-5DC	Ball	1/2"	Doublecut	2-1/4"	\$31.95
	MST-SD-5FM	Ball	1/2"	Alumacut	2-1/4"	\$41.05
	MST-SD-5L6DC	Ball	1/2"	Doublecut	6-1/2"	\$47.15
	MST-SE-1DC	Oval	1/4"	Doublecut	2"	\$25.05
	MST-SE-3DC	Oval	3/8"	Doublecut	2-3/8"	\$30.95
	MST-SE-5DC	Oval	1/2"	Doublecut	2-5/8"	\$43.95
	MST-SE-5L6DC	Oval	1/2"	Doublecut	6-7/8"	\$59.15
	MST-SF-3DC	Radius Tree	3/8"	Doublecut	2-1/2"	\$28.65
	MST-SF-3FM	Radius Tree	3/8"	Alumacut	2-1/2"	\$37.05
	MST-SF-3L6DC	Radius Tree	3/8"	Doublecut	6-3/4"	\$43.95
	MST-SF-3L6FM	Radius Tree	3/8"	Alumacut	6-3/4"	\$52.25
	MST-SF-5DC	Radius Tree	1/2"	Doublecut	2-3/4"	\$40.65
	MST-SF-5FM	Radius Tree	1/2"	Alumacut	2-3/4"	\$52.45
	MST-SF-5L6DC	Radius Tree	1/2"	Doublecut	7"	\$55.85
	MST-SF-5L6FM	Radius Tree	1/2"	Alumacut	7"	\$67.65
	MST-SG-1DC	Pointed Tree	1/4"	Doublecut	2"	\$22.85
	MST-SG-3DC	Pointed Tree	3/8"	Doublecut	2-1/2"	\$28.65
	MST-SG-3L6DC	Pointed Tree	3/8"	Doublecut	6-3/4"	\$43.95
	MST-SG-5DC	Pointed Tree	1/2"	Doublecut	2-3/4"	\$40.65
	MST-SG-5L6DC	Pointed Tree	1/2"	Doublecut	7"	\$55.85
	MST-SH-5DC	Flame	1/2"	Doublecut	3"	\$57.35
	MST-SJ-3DC	60° Included Cone	3/8"	Doublecut	2-1/16"	\$25.45
	MST-SJ-5DC	60° Included Cone	1/2"	Doublecut	2-3/16"	\$31.55
	MST-SK-3DC	90° Included Cone	3/8"	Doublecut	1-15/16"	\$25.45
	MST-SK-5DC	90° Included Cone	1/2"	Doublecut	2"	\$31.55
	MST-SL-3DC	14° Radius Cone	3/8"	Doublecut	2-13/16"	\$34.75
	MST-SL-3FM	14° Radius Cone	3/8"	Alumacut	2-13/16"	\$44.65
	MST-SL-3L6DC	14° Radius Cone	3/8"	Doublecut	7-1/16"	\$50.05
	MST-SL-4DC	14° Radius Cone	1/2"	Doublecut	3-1/64"	\$44.25
	MST-SL-4FM	14° Radius Cone	1/2"	Alumacut	3-1/64"	\$56.95
	MST-SL-4L6DC	14° Radius Cone	1/2"	Doublecut	7-1/8"	\$59.45
	MST-SL-4L6FM	14° Radius Cone	1/2"	Alumacut	7-1/8"	\$72.15
	MST-SM-2DC	14° Pointed Cone	1/4"	Doublecut	2"	\$23.95
	MST-SM-4DC	14° Pointed Cone	3/8"	Doublecut	2-1/2"	\$34.15
	MST-SM-5DC	14° Pointed Cone	1/2"	Doublecut	2-5/8"	\$43.95
	MST-SM-5L6DC	14° Pointed Cone	1/2"	Doublecut	6-7/8"	\$59.15
	MST-SN-2DC	13° Inverted Cone	3/8"	Doublecut	2-1/8"	\$39.15



Made in USA



MST-BK9 **\$303⁸⁵**

8-Pc Doublecut Burr Kit

- #SB-1DC: 1/4" cylindrical shape with end cut
- #SB-5DC: 1/2" cylindrical shape with end cut
- #SC-3DC: 3/8" radius cylindrical shape
- #SD-1DC: 1/4" ball shape
- #SF-3DC: 3/8" radius tree shape
- #SF-5DC: 1/2" radius tree shape
- #SG-3DC: 3/8" pointed tree shape
- #SL-3DC: 3/8" 14° radius cone shape
- Storage box



Made in USA



MST-LBK4 **\$211³⁵**

4-Pc, 6" Long Doublecut Burr Kit

- #SB-3L6DC: 3/8" cylindrical shape with end cut
- #SC-3L6DC: 3/8" radius cylindrical shape
- #SD-5L6DC: 1/2" ball shape
- #SF-5L6DC: 1/2" radius tree shape
- Plastic pouch

IRC-1814TIN **\$114⁵⁵**

6-Pc TiN-Coated Carbide Burr Kit

- Shank: 1/8" • Head diameter: 1/4"
- Kit includes: Cylindrical flat end; Radius cylindrical; Radius tree; Pointed tree; Oval; Ball



IR Ingersoll Rand.

ABRASIVES, CUTTING & GRINDING ACCESSORIES

Burrs

PA Astro

AST-2185 **\$134⁸⁵**

5-Pc 1/4" x 4.5" Double Cut Carbide Burr Set

- SF-5: Tree shape radius end 1/2" x 1"
- SF-3: Tree shape radius end 3/8" x 3/4"
- SD-3: Ball shape 3/8"
- SC-3: Cylindrical radius end 3/8" x 3/4"
- SA-5: Cylindrical shape 1/2" x 1"



SP AIR

Made in USA



SPA-SP-4BS **\$139⁹⁵**

4-Pc 1/4" Shank Carbide Burr Set

Includes:

- Cylindrical Flat End 1/4" Diameter x 5/8" Length
- Cylindrical Radius End 3/8" Diameter x 3/4" Length
- Tree Shape 1/2" Diameter x 1" Length
- Taper (14° Angle) 3/8" Diameter x 1-1/16" Length

ATD-8160 **\$167⁴⁵**

8-Pc 1/4" Double Cut Carbide Burr Set

- Cylindrical shape 1/2" x 1"
- Cylindrical shape 3/8" x 3/4"
- Cylindrical radius end 3/8" x 3/4"
- Cylindrical radius end 1/4" x 5/8"
- Ball shape 3/8"
- Ball shape 1/4"
- Tree shaped radius end 1/2" x 1"
- Tree shaped radius end 3/8" x 3/4"



ATD-8170 **\$132⁷⁵**

4-Pc 1/4" Shank x 6" Long Double Cut Carbide Burr Set

Open Stock 6" Long Carbide Burrs for #ATD-8170



Item #	Shape	Head Size	
ATD-8171	Ball End	3/8" Diameter	\$28.25
ATD-8172	Cylinder Radius End	3/8" Diameter x 3/4"	\$39.35
ATD-8173	Tree Shape	3/8" Diameter x 3/4"	\$39.35
ATD-8174	Tree Shape	1/2" Diameter x 1"	\$54.35

Hand Files

VIM

VIM-FS100 **\$112⁴⁵**

4-Pc File Set

- 12" Flat Bastard File
- 12" Semi-Round File
- 12" Slim Taper File
- 12" Round File



TIT-17068 **\$16⁵⁵**

5-Pc Precision File Set

- Profile shapes include: Round, Half Round, Flat, Knife & Triangle
- For use on wood, plastic, and soft metals
- Overall Length: 6.25"

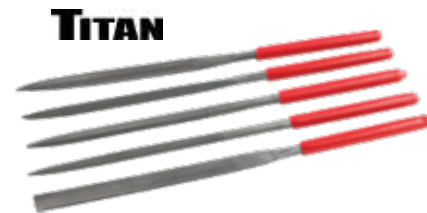

GW GEARWRENCH

GWR-82820H **\$117⁵⁵**

4-Pc Standard Bastard File Set

- 8" Flat bastard file
- 8" Half round bastard file
- 8" Round bastard file
- 8" Triangle bastard file



GWR-82821H **\$68⁵⁵**

6-Pc Mini Bastard File Set

- 4" Flat mini file
- 4" Round mini file
- 4" Half round mini file
- 4" Square mini file
- 4" Knife mini file
- 4" Triangle mini file



NIC-22030HNNN **\$227⁵⁵**

9-Pc Ergonomic File Set

- 12" Mill bastard cut
- 10" Mill bastard cut
- 10" Flat bastard cut
- 10" Half round bastard cut
- 10" round bastard file
- 8" Half round bastard cut
- 8" Flat bastard cut
- 6" XX Slim taper file
- 6" Slim taper file



NIC-22040HNNN **\$97⁵⁵**

5-Pc Ergonomic File Set

- 10" Mill bastard cut
- 10" Half round bastard cut
- 8" Mill bastard cut
- 8" Flat bastard cut
- 6" Slim taper file



NIC-T21455 **\$16³⁵**

8" File Cleaner

- Helps restore file grooves to clean cutting capacity



Surface Preparation Discs



Wolverine Type 29 Angled Abrasive Flap Discs

- Phenolic backing
- Fast cut rate



Item #	Diameter	Arbor Hole	Grit	Max. RPM	Qty	
WEI-31344	4-1/2"	7/8"	40	13,000	10	\$60.55
WEI-31345	4-1/2"	7/8"	60	13,000	10	\$60.55
WEI-31346	4-1/2"	7/8"	80	13,000	10	\$60.55
WEI-31347	4-1/2"	7/8"	120	13,000	10	\$60.55
WEI-31356	5"	7/8"	40	12,000	10	\$80.85
WEI-31357	5"	7/8"	60	12,000	10	\$80.85
WEI-31358	5"	7/8"	80	12,000	10	\$30.95



Premium Flat Face Ceramic Flap Discs

- Type 27 flat face • Fiberglass backing
- 7/8" hole • Max. 13,300 RPM



Item #	Diam.	Grit	Qty	
GLI-812745040	4.5"	40	5	\$34.05
GLI-812745060	4.5"	60	5	\$34.05
GLI-812745080	4.5"	80	5	\$34.05
GLI-812750040	5"	40	5	\$37.75
GLI-812750060	5"	60	5	\$37.75
GLI-812750080	5"	80	5	\$37.75



Premium Flat Face Zirconia Flap Discs

- Type 27 flat face
- Plastic roll-on locking style
- Fiberglass backing
- 2" disc max. RPM: 30,000
- 3" disc max. RPM: 20,000



Item #	Diam.	Grit	Qty	
GLI-22520305	2"	40	10	\$34.95
GLI-22520505	2"	60	10	\$34.05
GLI-22520605	2"	80	10	\$33.15
GLI-22520805	2"	120	10	\$31.85
GLI-22530305	3"	40	10	\$65.55
GLI-22530505	3"	60	10	\$63.75
GLI-22530605	3"	80	10	\$60.95



Brite Prep™ Surface Conditioning Discs

- Plastic roll-on locking style
- Optional 2" holder: #GLI-70020003
- Optional 3" holder: #GLI-70030001



Item #	Diameter	Grit	Qty	
GLI-25120853	2"	Coarse - Gold	50	\$72.55
GLI-25120903	2"	Medium - Maroon	50	\$70.95
GLI-25120923	2"	Very Fine - Blue	50	\$69.75
GLI-25120953	2"	Ultra Fine - Grey	50	\$70.85
GLI-25130853	3"	Coarse - Gold	25	\$63.15
GLI-25130903	3"	Medium - Maroon	25	\$61.25
GLI-25130923	3"	Very Fine - Blue	25	\$59.85
GLI-25130953	3"	Ultra Fine - Grey	25	\$61.15

Trim-Kut® Aluminum Oxide Abrasive Discs

- Max. 21,000 RPM

Item #	Diam.	Grit	Qty	
GLI-24130200	3"	24	25	\$65.15
GLI-24130300	3"	36	25	\$64.45
GLI-24130500	3"	60	25	\$63.35
GLI-24130600	3"	80	25	\$62.85
GLI-24130800	3"	120	25	\$62.45



Aluminum Oxide Discs

- Optional 2" holder: #GLI-70020003
- Optional 3" holder: #GLI-70030001

Item #	Diam.	Grit	Qty	
GLI-21220305	2"	36	50	\$46.35
GLI-21220505	2"	60	50	\$45.45
GLI-21220605	2"	80	50	\$45.05
GLI-21220805	2"	120	50	\$44.75
GLI-21230305	3"	36	25	\$29.25
GLI-21230505	3"	60	25	\$28.35
GLI-21230605	3"	80	25	\$27.85
GLI-21230805	3"	120	25	\$27.55



Premium Angle Face Zirconia Flap Discs

- Type 29 angle face
- Fiberglass backing
- 7/8" hole
- Max. 13,300 RPM



Item #	Diam.	Grit	Qty	
GLI-712945040	4.5"	40	5	\$25.15
GLI-712945060	4.5"	60	5	\$25.15
GLI-712945080	4.5"	80	5	\$25.15
GLI-712950040	5"	40	5	\$25.55
GLI-712950060	5"	60	5	\$8.85
GLI-712950080	5"	80	5	\$28.55

ABRASIVES, CUTTING & GRINDING ACCESSORIES

Surface Preparation Discs



Wolverine General Purpose Aluminum Oxide Resin Fiber Discs

Item #	Diameter	Arbor Hole	Grit	Qty	
WEI-59576	4-1/2"	7/8"	60	25	\$17.05
WEI-59577	4-1/2"	7/8"	80	25	\$13.95
WEI-59579	4-1/2"	7/8"	120	25	\$13.95
WEI-59506	5"	7/8"	60	25	\$16.05
WEI-59507	5"	7/8"	80	25	\$16.05
WEI-59509	5"	7/8"	120	25	\$16.05



Made in North America

Strip Away® Ceramic & Silicone Carbide Discs

- Plastic roll-on locking style • 1/2" thick discs
- Optional holders: 2" #GLI-70020003; 3" #GLI-70030001

Item #	Diam.	Type	RPM	Qty	
GLI-53209	2"	General Purpose (Black)	18,000	10	\$31.75
GLI-56209	2"	Supreme (Purple)	18,000	10	\$49.75
GLI-53211	3"	General Purpose (Black)	15,000	10	\$82.85
GLI-56211	3"	Supreme (Purple)	15,000	10	\$87.45



Green Corps™ Roloc™ Abrasive Discs

- Plastic roll-on locking style
- Optional 2" holder: #GLI-70020003
- Optional 3" holder: #GLI-70030001

Item #	Diam.	Grit	Qty	
3MM-36527	2"	80	25	\$78.75
3MM-36526	2"	60	25	\$83.05
3MM-36525	2"	40	25	\$87.55
3MM-36536	3"	80	25	\$85.95
3MM-36535	3"	60	25	\$95.75
3MM-36534	3"	40	25	\$103.75



3M

Strip Away® Ceramic & Silicone Carbide Discs

- Type 27 • Fiberglass backing
- 7/8" hole

Item #	Diam.	Type	RPM	Qty	
GLI-53064	4.5"	General Purpose (Black)	13,300	5	\$68.85
GLI-56064	4.5"	Supreme (Purple)	13,300	5	\$79.35
GLI-53065	5"	General Purpose (Black)	12,000	5	\$86.95
GLI-56065	5"	Supreme (Purple)	12,000	5	\$93.15



Scotch-Brite™ Roloc™ Surface Conditioning Discs

- Plastic roll-on locking style
- Optional 2" holder: #GLI-70020003
- Optional 3" holder: #GLI-70030001
- Optional 4" holder: #GLI-70040011

Item #	Diam.	Grit	Qty	
3MM-7480	2"	Coarse	25	\$52.95
3MM-7481	2"	Medium	25	\$69.15
3MM-7485	3"	Coarse	25	\$129.95
3MM-7486	3"	Medium	25	\$115.85
3MM-7482	4"	Coarse	10	\$49.55
3MM-7483	4"	Medium	10	\$61.35



3M

Scotch-Brite™ Roloc™ Bristle Discs (Box of 10)

- Conforms to workpiece
- Remove coatings, sealant and adhesives quickly, leaving a clean surface
- Optional 2" holder: #GLI-70020003
- Optional 3" holder: #GLI-70030001

Item #	Diam. x Hole	Type	Grit	
3MM-7524	2" x 5/8"	Coarse	50	\$125.95
3MM-7525	2" x 5/8"	Medium	80	\$125.95
3MM-7526	3" x 5/8"	Coarse	50	\$160.15
3MM-7527	3" x 5/8"	Medium	80	\$137.85



3M

Roll-On Disc Holders

ATD-6601 \$13²⁵ 2" Roloc™ Disc Holder



3MM-SB15408 \$36⁰⁵ Roloc™+ Holder, 1" x 1/4"

- Holder has deeper internal thread to accept products with 3M™ Roloc™+ Buttons
- Max. 25,000 RPM

3M



Rapid Change Disc Holders

- Plastic roll-on locking style

Item #	Size	
GLI-70020003	2"	\$7.45
GLI-70030001	3"	\$8.85
GLI-70040011	4"	\$15.15



Arbors



SGT-94950 \$12⁸⁵ Arbor for Cut-Off Wheels

- Allows any die grinder or drill to be turned into a cut-off tool using either 1/4" or 3/8" I.D. cut-off wheels



WEI-07727 \$9³⁵ Threaded Shaft Drive Arbor

- Max. brush diameter: 3"
- Arbor hole size: 3/8"
- Stem diam. x length: 1/4" x 3/4"
- Max. 25,000 RPM

Cut-Off Wheels



3" Aluminum Oxide Cut-Off Wheels

- Pack of 10

Item #	Grit	Thickness	Arbor Hole	Max. RPM	
SHA-12700	60	1/32"	3/8" Hole	25,000	\$17.05
SHA-12704	54	1/16"	3/8" Hole	25,000	\$17.05



56118



General Purpose Wolverine Aluminum Oxide Thin Cutting Wheels

- Fast cutting on metal
- Type 1: flat center
- Type 27: depressed center

Item #	Diam./Type	Face Width	Grit	Arbor Hole	Max. RPM	Qty	
WEI-56061	3" Type 1	0.035"	60	1/4"	25,000	25	\$46.65
WEI-56281	4.5" Type 1	0.045"	60	7/8"	13,300	25	\$62.65
WEI-56118	5" Type 1	1/16"	36	7/8"	12,200	25	\$50.05
WEI-56393	4.5" Type 27	0.045"	60	7/8"	13,300	25	\$62.65
WEI-56392	5" Type 27	0.045"	60	7/8"	12,200	25	\$71.35



57020



Tiger General Purpose Aluminum Oxide Thin Cutting Wheels

- Type 1: flat center
- Type 27: depressed center

Item #	Diam./Type	Face Width	Grit	Arbor Hole	Max. RPM	Qty	
WEI-57020	4.5" Type 1	0.045"	60	7/8"	13,300	25	\$92.75
WEI-57041	4.5" Type 27	0.045"	60	7/8"	13,300	25	\$36.65
WEI-57043	5" Type 27	0.045"	60	7/8"	12,200	25	\$38.45



LENOX® METALMAX™ Diamond Edge Cutting Wheels

Item #	Diam.	Thick.	Arbor	Application	
LEN-1972918	3"	.050"	3/8"	Die Grinder	\$28.15
LEN-1972921	4.5"	.050"	7/8"	Angle Grinder	\$26.45
LEN-1972922	5"	.050"	7/8"	Angle Grinder	\$35.25
LEN-1972923	6"	.050"	7/8"	Angle Grinder/Circular Saw	\$48.25
LEN-1972929	14"	.130"	1"	Chop Saw	\$191.05

Grinding Wheels



3-in-1 Diamond Grinding Wheels

- Grind (fig. 1), cut (fig. 2), and undercut (fig. 3)
- Minimum increased life of 2,000%

Item #	Diam.	Arbor/Shank	
IPA-8120	2"	1/4" Shank	\$46.55
IPA-8151	3"	3/8" Arbor with 1/4" Shank Adapter	\$45.35



Tiger General Purpose Aluminum Oxide Grinding Wheels

- Type 27 wheels with depressed center

Item #	Diameter	Face Width	Grit	Arbor Hole	Max. RPM	Qty	
WEI-57121	4.5"	1/4"	24	7/8"	13,300	10	\$18.65
WEI-57123	5"	1/4"	24	7/8"	12,200	10	\$21.35



General Purpose Aluminum Oxide Fast Grinding Wheels

- Type 27 wheels with depressed center
- For use on metal

Item #	Diameter	Face Width	Grit	Arbor Hole	Max. RPM	Qty	
WEI-56464	4-1/2"	1/4"	24	7/8"	13,300	10	\$11.95
WEI-56466	5"	1/4"	24	7/8"	12,200	10	\$43.25

DRILL BITS, STEP DRILL BITS, FASTENER EXTRACTORS

Drill Bits

Industrial Quality Drill Bits



AMT-33-0001P **\$339¹⁵**
29-Pc Fractional Drill Bit Set
 • 1/16" to 1/2" by 1/64"

AMT-33-0001 **\$339¹⁵**
29-Pc Fractional Drill Bit Set
 • 1/16" to 1/2" by 1/64"



AMT-35-0002 **\$660⁵⁵**
8-Pc 1/2" Shaft Hex Shank Drill Bit Set
 • 9/16" - 13/16" - 5/8" - 7/8" - 11/16" - 15/16" - 3/4" - 1"



Premium Grade Drill Bit Sets

• Sizes increments by 1/64ths

Item #	Count	Description	Size Range	
KNK-21KK5	21-Piece	Standard Length	1/16" - 3/8"	\$172.15
KNK-21KK7	21-Piece	Short Length	1/16" - 3/8"	\$147.55
KNK-29KK5DB	29-Piece	Standard Length	1/16" - 1/2"	\$319.85
KNK-29KK10	29-Piece	Standard Length with Split Point Step Design	1/16" - 1/2"	\$543.15
KNK-13KK6	13-Piece	Left Hand	1/16" - 1/4"	\$197.55
KNK-4KK12SP	4-Piece	1/2" Reduced Shank	9/16" - 1"	\$357.45



AMT-70-03 **\$37⁵⁵**
Cooling Foam Tool Spray for Drill Bits & Cutting Tools, 400 ml

- Increases drill bit life and cutting tool times by almost 100%
- Increases the cutting performance of metal saws by up to 40%



TS21



TS29



Onyx Turbostep HSS Drill Bit Sets

- Spiral fluted stepped tip drill bits outperform every conventional drill bit design in nearly all materials, eliminates bit walk and the need for pilot holes
- Excels on hard alloys, sheet metal, and imperfect parts that are difficult to start drilling into



Item #	Count	Length	Size Range	
AST-TS21	21-Piece	Mechanics Length	1/16" - 3/8"	\$221.75
AST-TS29	29-Piece	Reduced Shank Mechanics Length	1/16" - 1/2"	\$375.55



ATD-9204 **\$3⁹⁵**
1/8" Double-Ended Titanium Drill Bit Set
 • 2" length
 • 12 pack



9215



9229



Titanium Coated Drill Bit Sets

Item #	Description	Size Range	
ATD-9215	5-Piece Left-Hand Set	5/64" - 19/64"	\$18.65
ATD-9229	29 Piece Set	1/16" - 1/2"	\$88.25

DRILL BITS, STEP DRILL BITS, FASTENER EXTRACTORS

Drill Bits

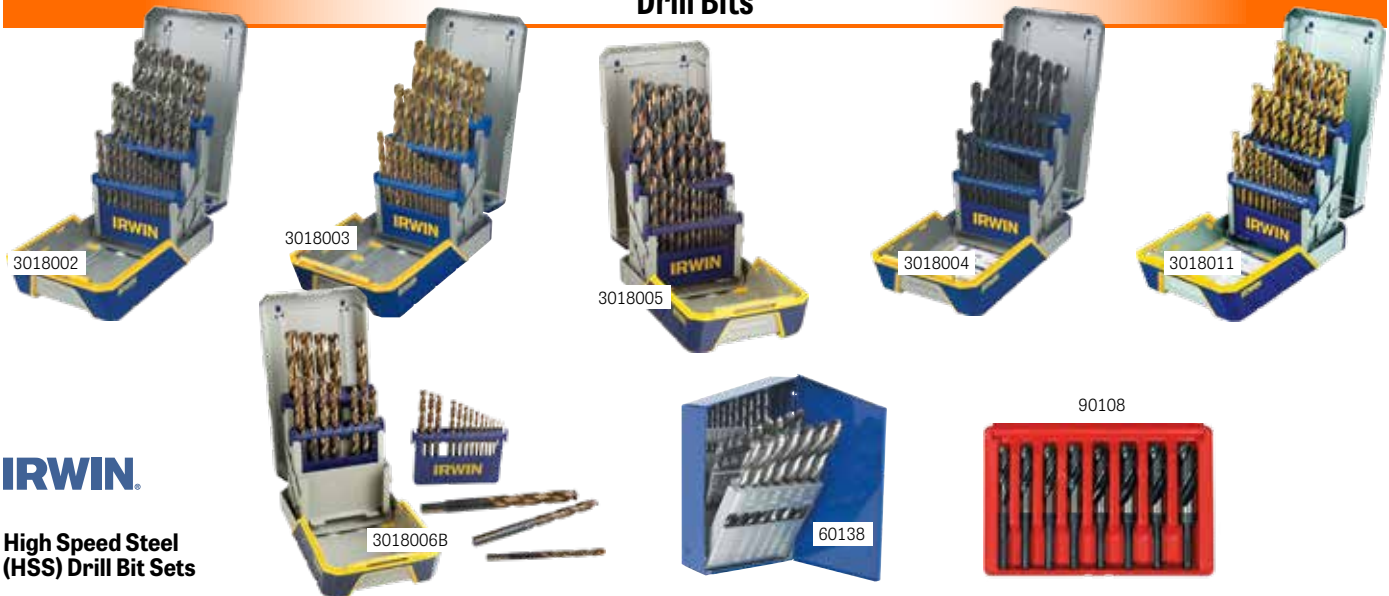

IRWIN

High Speed Steel (HSS) Drill Bit Sets

Item #	Description	Finish	Contents	Point	
IRW-3018002	29-Pc Set – 3/8" Reduced Shank	Cobalt M35	1/16" - 1/2" by 64ths	135°	\$210.15
IRW-3018003	29-Pc Set – 3/8" Reduced Shank	Titanium	1/16" - 1/2" by 64ths	135°	\$243.85
IRW-3018005	29-Pc Set – 3/8" Reduced Shank	Black & Gold Oxide	1/16" - 1/2" by 64ths	135°	\$151.15
IRW-3018004	29-Pc Set – 3/8" Reduced Shank	Black Oxide	1/16" - 1/2" by 64ths	135°	\$134.45
IRW-3018011	29-Pc Set – TURBOMAX 3/8" Reduced Shank	Titanium	1/16" - 1/2" by 64ths	TURBOMAX	\$204.95
IRW-3018006B	29-Pc Set – TURBOMAX 3/8" Reduced Shank	Black & Gold Oxide	1/16" - 1/2" by 64ths	TURBOMAX	\$236.25
IRW-60138	29-Pc Set – General Purpose	Bright	1/16" - 1/2" by 64ths	118°	\$152.35
IRW-90108	8-Pc Set – 1/2" Reduced Shank	Black Oxide & Bright	9/16" - 1" by 32nds	118°	\$328.05

IRWIN

Double-End HSS Drill Bits

- Black oxide coating
- 135° split-point tip

Item #	Size	
IRW-60608	1/8"	\$2.15
IRW-60612	3/16"	\$3.55
IRW-60616	1/4"	\$4.95

TOOL AID
PROFESSIONAL AUTOMOTIVE TOOLS

SGT-15210 \$7⁸⁵
1/8" Stubby Body Panel Drill Bits with Double Ends

- Made of high speed steel for sheet metal
- 135° split point
- Pack of 10



MULLER
TOOLS

MUK-562 600 \$174⁵⁵
4-Pc Carbide Tip Drill Bit Set

- For drilling extremely hard materials
- 3, 4, 6, 7 mm bits



Milwaukee



RED HELIX™ Twist Drill Bit Sets

- 135° split point tip

Item #	Description	Size Range	
MLW-48-89-4670	15-Pc Shockwave™ Impact Duty TITANIUM Drill Bits	1/16" – 3/8"	\$37.25
MLW-48-89-4631	23-Pc Shockwave™ Impact Duty TITANIUM Drill Bits	1/16" – 3/8"	\$40.05
MLW-48-89-2370	15-Pc Red Helix™ COBALT Drill Bits	1/16" – 3/8"	\$57.75
MLW-48-89-2338	23-Pc COBALT Drill Bits	1/16" – 3/8"	\$100.65

DRILL BITS, STEP DRILL BITS, FASTENER EXTRACTORS

Step Drill Bits

KNK-3KK4SR **\$273⁸⁵**

3-Pc Step Drill Bit & Reamer Set

- 5/16" - 9/16", 9/16" - 13/16", 13/16" - 1-1/16"
- 90° notch point starts holes easily
- 5 hole enlargement steps
- 3/8" shank with 3 flats



IRW-15502 **\$191⁸⁵**
3-Pc Titanium Step Drill Bit Set

- Size #1T: 1/8" - 1/2" (1/32" steps)
13 hole sizes
- Size #2T: 3/16" - 1/2" (1/16" steps)
6 hole sizes
- Size #3T: 1/4" - 3/4" (1/16" steps)
9 hole sizes

IRWIN
Unibit.

IRW-10502ZR **\$143⁹⁵**

3-Pc Self Starting Step Drill Bit Set

- Contains:
- Size #1: 1/8" to 1/2"
 - Size #2: 3/16" to 1/2"
 - Size #3: 1/4" to 3/4"



IRWIN
Unibit.

ATD-9200 **\$56⁴⁵**

5-Pc Step Drill Bit Set

- Tri-flat shank design for a sure grip in the chuck without slippage
- Set includes:

- 1/4" shank: 3/16" to 1/2" holes in 1/16" steps
- 1/4" shank: 1/8" to 1/2" holes in 1/32" steps
- 3/8" shank: 1/4" to 3/4" holes in 1/16" steps
- 3/8" shank: 3/16" to 7/8" holes in 1/16" steps
- 3/8" shank: 1/4" to 1-3/8" holes in 1/8" steps



High Speed Steel Step Drill Bits

- Speed start tip prevents bit walking
- 1/4" hex shank

Item #	Size	Steps	
MLW-48-89-9201	1/8" - 1/2"	13	\$35.95
MLW-48-89-9203	1/4" - 3/4"	9	\$56.05
MLW-48-89-9204	3/16" - 7/8"	12	\$56.45
MLW-48-89-9208	1/2" - 1"	9	\$74.35
MLW-48-89-9211	7/8" - 1-7/32"	13	\$98.35

Milwaukee



MLW-48-89-9221 **\$143⁸⁵**

3-Pc JAM-FREE Performance Step Drill Bit Set

- Optimized for cordless drills in high speed
- Rapid Strike™ tip • Black oxide finish
- #1 - 1/8" - 1/2" by 1/32" - 13 steps
- #2 - 3/16" - 1/2" by 1/16" - 6 steps
- #4 - 3/16" - 7/8" by 1/16" - 12 steps



\$ While Q'tys. Last

AP Astro

AST-9442 **\$53³⁵**

2-Pc Blue Steel Max-Duty Step Drill Set

- Titanium Aluminum Nitride wear-preventative coating
- High speed steel
- Sizes: up to 1/2" in 1/32"; up to 3/4" in 1/16"



IRWIN
Unibit.



High Speed Steel Step Drills

Item #	Description	# of Hole Sizes	Hex Shank	
IRW-10231	#1 1/8"-1/2" (1/32" steps)	13	1/4"	\$39.05
IRW-15101ZR	#1 1/8"-1/2" (1/32" steps) Titanium	13	1/4"	\$51.95
IRW-10232	#2 3/16"-1/2" (1/16" steps)	6	1/4"	\$39.05
IRW-10233	#3 1/4"-3/4" (1/16" steps)	9	3/8"	\$70.35
IRW-10234	#4 3/16"-7/8" (1/16" steps)	12	3/8"	\$83.15
IRW-10235	#5 1/4"-1-3/8" (1/8" steps)	10	7/16"	\$147.35
IRW-10310	#10 1/2"	1	1/4"	\$37.85
IRW-10311ZR	#11 7/8"	1	3/8"	\$78.05
IRW-10312ZR	#12 3/8"	1	1/4"	\$30.45
IRW-10313ZR	#13 1-1/8"	1	7/16"	\$100.55
IRW-10220	#20 9/16"-1" (hole enlarging)	8	7/16"	\$80.45
IRW-10221	#21 13/16"-1-3/8" (hole enlarging)	10	7/16"	\$163.25

TITAN

High Speed Steel Step Drill Bits

- Titanium finish
- 1/4" hex shank

Item #	Size	Steps	
TIT-16501	1/8" - 1/2"	13	\$16.75
TIT-16504	1/4" - 3/4"	9	\$22.85
TIT-16503	3-Piece Set:		
	1/8" - 1/2"	13	\$33.35
	3/16" - 1/2"	6	
	1/4" - 3/4"	9	

16501



16504



16503

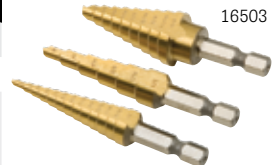

DRILL BITS, STEP DRILL BITS, FASTENER EXTRACTORS

Fastener Extractors



KNK-10KK7-LHSQX **\$159⁵⁵**

10-Pc Left Hand Screw Machine Drill & Square Extractor Set

- Stubby length drill bits: 1/8", 3/16", 1/4", 5/16", 3/8"
- Square Extractors: SQE1, SQE2, SQE3, SQE4, SQE5
- 135° split point and 3 flats on the shanks



AST-9447 **\$70⁰⁵**

25-Pc Screw Extractor/ Drill & Guide Set

- Extracts screws and bolts
- Removes broken fastener without breaking or jamming
- For use on thread sizes 5mm-16mm



IRW-11135ZR **\$329⁸⁵**

35-Pc Screw Extractor & Drill Bit Set

- Spiral flute screw extractors: EX-1, EX-2, EX-3, EX-4, EX-5, EX-6
- 13 Multi-spline extractors: 1/8" - 1/2"
- 16 Drill Bits in sizes: 5/64" - 1/2"



IRWIN
HANSON.

IRW-3101010 **\$527⁸⁵**

48-Pc Master Extractor Set

- 6 Spiral flute extractors
- 13 Multi-spline extractors
- 13 Bolt extractors
- 16 Left-hand cobalt drill bits



IRWIN
HANSON.

IRW-11119 **\$73⁸⁵**

10-Pc Spiral Extractor & Drill Bit Set in Metal Index

- Aggressive left hand spiral design
- Designed to remove broken studs, bolts, socket screws and fittings
- Spiral flute screw extractors: EX-1, EX-2, EX-3, EX-4, EX-5
- Drill bits: 5/64", 7/64", 5/32", 1/4", 19/64"



IRWIN
HANSON.

TIT-16013 **\$25²⁵**

10-Pc Left Hand Drill Bit & Screw Extractor

- (5) Left-hand cobalt drill bits
- (5) Multi-fluted, machined alloy steel screw extractors: 5/64", 7/64", 5/32", 1/4", and 19/64"



TITAN

TITAN

TIT-16082 **\$104⁵⁵**

9-Pc Screw Extractor Set

- Designed to remove broken studs, bolts, sockets, screws and fittings
- Left hand spiral design
- Includes sizes: #1 to #9



GRI-53100 **\$19⁴⁵**

8-Pc Jumbo Screw Extractor Set

- Made of drop forged, heat-treated carbon steel
- Tapered counterclockwise threads
- Includes sizes: #1 to #8



KNI-9R 471 900 3 **\$104²⁵**

5-Pc Bolt & Screw Double-Edged Extractor Set

- Sizes 1 to 5
- Comes in a vinyl pouch



IRWIN
HANSON.

53635



53535



Screw Extractor Sets

Item #	Description	Size Range	
IRW-53535	5-Pc Spiral Flute Set	EX-1 to EX-5	\$19.05
IRW-53635	5-Pc Straight Flute Set	ST-1 to ST-5	\$24.05
IRW-53645	6-Pc Straight Flute Set	ST-1 to ST-6	\$32.45

9CL-90372 **\$76³⁵**

15-Pc Screw Extractor Set

- Hex 12mm: 3mm, 4mm, 5mm, 5.5mm, 6mm, 8mm, 10mm, 1/8", 3/16", 1/4", 3/8"
- Hex 16mm: 11mm, 12mm, 14mm, 1/2"



9CIRCLE

IRWIN
HANSON.

53226



Hex Head Multi-Spline Screw Extractor Sets

Item #	Description	Size Range	
IRW-53226	10-Piece Set	1/8" to 13/32"	\$46.95
IRW-53227	25-Piece Set	1/8" to 7/8"	\$120.75



G-FORS™ EXTRACTORS

\$329¹⁵

GPE-GE14FORSESRT
**14-Pc G-FORS™
(Foreign Object Removal System)
Extractor Set**

- #1 to #7 extractors with 3/32" to 23/64" left hand drill bits
- Extractor is designed to be hammered and provides quick and easy removal of extracted object
- Designed to **grip up to 100% rounded fasteners**
- G-FORS™ extractor design **PREVENTS** fastener expansion and thread binding vs. standard tapered extractors that CAUSE fastener expansion leading to thread binding
- Unique non tapered geometry enables increased **GRIP** with the fastener sidewall
- Unique bi-directional design for loosening & tightening damaged fasteners
- S2 steel for increased strength and durability



GE8ASMHSRTP



GE11ASSHSRTP



GE7BSMHSRPT



GE7BSSHSRPT



GE9ASTSRPT



GE14ASTSRPT

RPT™ (Rounding Prevention Technology™) Hex and Torx® Bit Socket Sets

- Completely replaces your standard Hex or Torx® tools
- Patented unique bi-directional design enables loosening & tightening of new and damaged fasteners
- RPT™ Technology **prevents rounding** of NEW and compromised fasteners
- RPT™ Technology provides up to **50% more torque on NEW fasteners**
- RPT™ Technology provides up to **400% more torque on DAMAGED fasteners**
- S2 steel for increased strength and durability



RPT™ HEX

Item #	Drive	Set	Range	
GPE-GE8ASMHSRPT	1/4"	8-Pc	1.5mm – 7mm	\$111.75
GPE-GE11ASSHSRPT	1/4"	11-Pc	1/16" – 9/32"	\$124.15
GPE-GE7BSMHSRPT	3/8"	7-Pc	4mm – 10mm	\$124.15
GPE-GE7BSSHSRPT	3/8"	7-Pc	1/8" – 3/8"	\$124.15

RPT™ TORX®

Item #	Drive	Set	Range	
GPE-GE9ASTSRPT	1/4"	9-Pc	T6 – T40	\$120.45
GPE-GE14STSRPT	1/4", 3/8", 1/2"	14-Pc	T6 – T60	\$211.15



GE9AMSESRT



GE9ASSESRT



GE10BMSESRT



GE7BSESRT



RPT™ SOCKET EXTRACTORS

- RPT™ Socket Extractors replace multiple sets of extractors
- Unique non tapered geometry enables **EXTREME GRIP** on up to **100% damaged fasteners**
- Unique bi-directional design for loosening & tightening damaged fasteners
- G-FORS™ pusher rod provides quick and easy removal of extracted object

Item #	Drive	Set	Range	
GPE-GE9AMSESRT	1/4"	9-Pc	4mm – 12mm	\$211.15
GPE-GE9ASSESRT	1/4"	9-Pc	3/16" – 1/2"	\$211.15
GPE-GE10BMSESRT	3/8"	10-Pc	10mm – 19mm	\$300.55
GPE-GE7BSESRT	3/8"	7-Pc	3/8" – 3/4"	\$226.05

DRILL BITS, STEP DRILL BITS, FASTENER EXTRACTORS

Fastener Extractors



MAY-37331 **\$78⁰⁵**

4-Pc Screw Extractor Set

- D15/32" S3/4" • D9/16" D7/8"
- D21/32" S1-1/8" • D13/16" S1-3/8"



MAY-37332 **\$44⁷⁵**

5-Pc Screw Extractor Set

- D1/8" S1/4"-5/16" • D3/16" S3/8"
- D15/64" S7/16" • D5/16" S1/2-9/16"
- D3/8" S5/8"



MAY-37345 **\$201⁷⁵**

10-Pc Bolt Extractor Set

- Sizes: 6mm (1/4") - 38mm (1-1/2")
- For easy removal of broken or damaged screws, bolts, studs, and pipes



84787



84786

Bolt Biter™ Screw Extractor Sets

Item #	Set	Size Range	
GWR-84787	4-Pc	Screw Extractors: 1, 2, 3, 4 (≤1/4"-5/8", M5-M16)	\$39.75
GWR-84786	10-Pc	Screw Extractors: 1, 2, 3, 4 (≤1/4"-5/8", M5-M16) Right-Hand Drill Bits: 1/8", 3/16", 9/32", 3/8", 7/16"	\$107.15

GWR-86090 **\$38²⁵**

2-Pc Bolt Biter™ Impact Screwdriver Set for Damaged Fasteners

- Phillips and slotted
- Steel end cap designed for striking impact to drive 12° rotation



84784



Bolt Biter™ 1/4" & 3/8" Drive Impact Extraction Socket Sets for Damaged Fasteners

- Works with hand and power tools
- #86071 includes minus-sized for extremely worn-down fasteners • Lifetime warranty

Item #	Kit	Drive	Length	Size Range	
GWR-84782	8-Pc	1/4" & 3/8"	Stand.	7-16mm, 5/16"-5/8"	\$68.85
GWR-84783	15-Pc	1/4" & 3/8"	Stand.	7-19mm, 1/4"-3/4"	\$195.95
GWR-84784	28-Pc	1/4" & 3/8"	Stand.	7-19mm, 1/4"-3/4"	\$286.45
GWR-86070	5-Pc	1/2"	Deep	19-25mm, 3/4"-1"	\$145.35
GWR-86071	10-Pc	1/2"	Deep	19-25mm, 3/4"-1" Includes minus sizes	\$271.35

10-Pc Bolt Extractor Sets

- Unique snowflake shape hex sockets are used for removing stuck or damaged bolts, nut and screws
- Use with a 3/8" square drive ratchet
- Kits include a punch rod



Item #	Range	
CTA-1232	Metric: 8mm - 19mm	\$123.45
CTA-1234	SAE: 1/4" - 3/4"	\$123.45



GWR-86171 **\$195⁹⁵**

16-Pc Bolt Biter™ Nut Extractor & Driver Set

- For removing or tightening damaged fasteners
- SAE: 1/4"-1/2"
- Metric: 7mm-13mm
- Kit includes minus-sized a wider range of damaged fasteners



BOLT-GRIP® Bolt Extractors

Item #	Description	Range	Drive	
IRW-54009	9-Piece Fractional Set	1/4" to 3/4"	3/8"	\$162.05
IRW-54019	9-Piece Metric Set	8mm to 19mm	3/8"	\$162.05
IRW-54113	13-Piece Professional Industrial Set	1/4" to 3/4" 6mm to 19mm	3/8"	\$224.45
IRW-54125	5-Piece Lugnut Specialty Set	3/4" to 1" 19mm to 24mm	1/2"	\$158.55



4400

4501



Twist Socket Damaged Fastener Removal System

Item #	Description	Size Range	
LOC-4501	3/8" Drive - 9-Piece	10mm, 11mm (7/16"), 12mm, 13mm, 14mm, 15mm, 16mm (5/8"), 17mm, 19mm (3/4")	\$202.05
LOC-4400	1/2" Drive - 6-Piece	19mm (3/4"), 13/16", 7/8", 15/16", 1", Extractor Punch	\$168.35



Stud Puller Sets



Item #	Description	
ASM-201	4-Pc - 6, 8, 10, 12mm	\$97.75
ASM-201-7	5-Pc - 6, 7, 8, 10, 12mm	\$129.85
ASM-202	5-Pc - 1/4", 5/16", 3/8", 7/12", 1/2"	\$127.35
ASM-203	7-Pc - 1/4", 5/16", 3/8", 7/12", 1/2", 9/16", 5/8"	\$185.15

IRWIN
HANSON.

Tap & Die

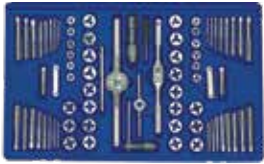

IRW-26377 **\$601⁶⁵**
**117-Pc Machine Screw/
Fractional/Metric Tap, Die,
Extractor & Drill Bit Set**
 • Thread size machine screw:
#4 to #12
 • Fractional: 1/4" to 1/2"
 • Metric: 3mm to 12mm
 • Pipe: 1/8" - 27 NPT; 1/8" - 28 BSP
 • Spiral flute screw extractor:
EX-1 to EX-5
 • Drill Bit sizes: 5/64" to 19/64"



IRW-26376 **\$401⁶⁵**
**76-Pc Machine Screw/
Fractional/Metric
Tap & Hex Die Set**
 • Thread size machine screw:
#4 to #12
 • Fractional: 1/4" to 1/2"
 • Metric: 3mm to 12mm
 • Pipe: 1/8" - 27 NPT;
1/8" - 28 BSP



IRW-26394 **\$478⁶⁵**
**53-Pc Metric
Tap & Hex Die Set**
 • Thread size metric screw:
3mm to 18mm
 • Pipe: 1/8" - 28 BSP;
1/4" - 19 BSP



IRW-24640 **\$444⁰⁵**
**53-Pc Machine Screw/
Fractional Tap & Hex Die Set**
 • Thread size machine screw:
#6 to #12
 • Fractional: 1/4" to 3/4"
 • Pipe: 1/8" - 27 NPT; 1/4" - 18 NPT



IRW-26317 **\$238⁹⁵**
**41-Pc Metric
Tap & Hex Die Set**
 • Thread size metric:
3mm to 12mm
 • Pipe: 1/8" - 28 BSP



IRW-24606 **\$238⁹⁵**
**41-Pc Machine Screw/
Fractional Tap & Hex Die Set**
 • Thread size machine screw:
#4 to #12
 • Fractional: 1/4" to 1/2"
 • Pipe: 1/8" - 27 NPT



IRW-97311 **\$553²⁵**
**25-Pc Metric
Tap & Hex Die Set**
 • Thread size metric:
14mm to 24mm



IRW-97094ZR **\$553²⁵**
**25-Pc Fractional
Tap & Hex Die Set**
 • Thread size fractional: 9/16" to 1"
 • Pipe: 1/4" - 18 NPT

ATD-276 **\$284²⁵**
**76-Pc SAE & Metric
Tap & Die Set**
 • SAE: #4 to 1/2"
 • Metric: 3mm to 12mm

ATD



ATD-277 **\$415⁶⁵**
**117-Pc SAE & Metric
Tap & Die Set with
Drill Bits**
 • SAE: #4 to 1/2";
 • Metric: 3mm to 12mm
 • 36 drill bits:
#3 to #43; 5/64" to 29/64";
B, F, H, I, J, O, Q, R, S, U, Z



GW GEARWRENCH



Tap and Die Sets

Item #	Description	Size Range	
GWR-82812	114-Pc SAE/Metric	#4 - 3/4" and - 18mm	\$564.25
GWR-3886	40-Pc Metric	3mm - 12mm	\$220.05
GWR-3887	75-Pc SAE/Metric	#4 - 1/2" and 3mm - 12mm	\$304.65

Tap Wrenches

T-Handle Ratcheting Tap Wrench

- Designed for use with taps, reamers, screw extractors and other tools with a square shank

IRWIN
HANSON.



Item #	Length	Tap Sizes	
IRW-21101	Standard	No. 0 to 1/4" (3mm to 6mm)	\$33.55
IRW-21210ZR	10"	No. 0 to 1/4" (3mm to 6mm)	\$42.25
IRW-21202	Standard	1/4" to 1/2" (6mm to 12mm)	\$39.95
IRW-21212ZR	12"	1/4" to 1/2" (6mm to 12mm)	\$47.05

IRW-12088 **\$23⁵⁵**
Adjustable Tap Handle & Reamer Wrench
 • For taps No. 0 to 1/2" (3mm to 12mm)



IRWIN
HANSON.

Tap Sockets

LIS-70500 **\$59⁶⁵**

8-Pc Tap Socket Set

- Set of sockets fit all number and fractional standard taps thru 1/2"
- Also fits 1/8" NPT taps and metric taps thru 12mm



LIS-70940 **\$46⁹⁵**

3-Pc Tap Socket Set

- Fits 5/8" (16mm), 11/16" (18mm) and 3/4"



LIS-71670 **\$126⁸⁵**

5-Pc Large Tap Socket Set

- Fits 5/8" (16mm), 11/16" (18mm), 3/4", 7/8" (22mm) and 1" (25mm)

Thread Restoring Tools

OTC-7402 **\$179⁰⁵**

OTC

Universal Outside Thread Chaser

- Restores threads to near new condition
- Use for 1-1/4" to 5" O.D.
- Includes 6 SAE dies (4, 5, 6, 7, 7-1/2, 8, 9, 10, 11, 11-1/2, 12, 14, 16, 18, 20, 24 threads per inch)



NIC-T33024 **\$114¹⁵**

CRESCENT NICHOLSON

4-Pc Thread Restoring File Set

- Restores damaged or worn external threads
- Regular bolt: 11, 12, 13, 14, 16, 18, 20, 24 TPI
- Extra-fine/extra-coarse bolt: 9, 10, 12, 16, 20, 27, 28, 32 TPI
- Regular pipe: 8, 10, 11 1/2, 14, 16, 18, 24, 27 TPI
- Metric bolt: .80, 1.00, 1.25, 1.50, 1.75, 2.00, 2.50, 3.00 mm



LANG TOOLS

LAN-2573 **\$53⁴⁵**

3-Pc Thread Restorer File Set

- SAE (threads per inch): 9, 10, 11, 12, 13, 14, 16, 18, 20, 24, 27, 28 and 32
- Metric (mm per thread): 0.75, 1.00, 1.25, 1.50, 1.75, 2.00, 2.50, 3.00



ATA

CTA-8185 **\$102⁰⁵**

4-Pc Thread Restoring File Set

- (3) Metric & SAE thread files (#8231, #8233, #8235):
 - SAE pitch sizes: 11, 12, 13, 14, 16, 18, 20, 24 threads per inch
 - 9, 10, 12, 16, 20, 27, 28, 32 threads per inch
 - Metric pitch sizes: 0.80, 1.00, 1.25, 1.50, 1.75, 2.00, 2.50, 3.00mm
- (1) Universal metric & SAE, single blade file to renew and refresh threads (#2299)



LANG TOOLS

LAN-971 **\$185⁶⁵**

48-Pc SAE and Metric Thread Restorer Kit

- (7) SAE coarse dies: 1/4"-20 to 5/8"-11
- (6) SAE coarse taps: 1/4"-20 to 9/16"-12
- (7) SAE fine dies: 1/4"-28 to 5/8"-18
- (6) SAE fine taps: 1/4"-28 to 9/16"-18
- (10) Metric dies: M6-1.00 to M14-1.50
- (10) Metric taps: M6-1.00 to M14-1.50
- (2) Files: 11 to 24 TPI and 0.75 to 3.00mm



Specialty Rethreaders

SLY-16000 **\$184⁵⁵**

Diesel Exhaust Temperature Sensor Bung Re-Threader Kit

- Cleans up most types of damaged EGT sensor bungs and allows a new sensor to be installed without needing to replace the very expensive exhaust system
- Works on cars as well as light, medium and heavy duty trucks
- 6 sizes: 12x1.0, 12x1.25, 12x1.5, 14x1.25, 14x1.5, 16x1.5



TOOLS
SPECIALTY PRODUCTS, INC.

LAN-1030 **\$65⁷⁵**

LANG TOOLS

5-Pc Spark Plug Thread Chaser Tap Set

- Works to restore and clean threads in spark plugs, NOx sensors and many other applications
- Includes: M10x1.0, M12x1.25, M14x1.25, M18x1.5 and M20x1.5



METAL WORKS

Made in Germany

NEW

Extra Short Rethreading Taps for Sensors

- Super short taps with integrated guide pin
- Rethreads the damaged and burned threads especially of NOx sensors and particle filters at exhaust systems



Item #	Size	Ideal For	
MUK-506 512	M12x1.25	Temperature Sensors	\$157.45
MUK-506 514	M14x1.5	Temperature Sensors	\$157.45
MUK-506 518	M18x1.5	Oxygen Sensors	\$157.45
MUK-506 520	M20x1.5	NOx Sensors	\$174.55
MUK-506 522	M22x1.5	Particle Filters	\$174.55
MUK-506 021/KIT	2-Pc Kit: M20x1.5 + M22x1.5	NOx Sensors Particle Filters	\$327.15

9CL-91300 **\$95⁹⁵**

8-Pc Axle Spindle Rethreading Set

- Repairs damaged or stripped CV joint threads
- Sizes: M20 x 1.25, M20 x 1.50, M22 x 1.00, M22 x 1.50, M24 x 1.50, M24 x 2.00, 3/4" UNEF, 13/16" UNEF



9CIRCLE

AME-31210 **\$326⁰⁵**

AME TOOLS

9-Pc Stud Rethreading Kit

- Repairs damaged wheel studs
- For passenger, light truck, and heavy-duty vehicles
- **SAE:** 7/16"-20, 1/2"-20, 9/16"-18, 5/8"-18
- **Metric:** 12mm-1.25, 12mm-1.50, 12mm-1.75, 14mm-1.50, 14mm-2.0



SCRAPERS

TIT-11500 **\$13²⁵**

1-1/4" Stainless Steel Scraper



TIT-11504 **\$18⁶⁵**

3" Offset Stainless Steel Scraper

TITAN

Lisle

1.5" Stainless Steel Scrapers

• Metal capped end

Item #	Description	
LIS-83640	Straight Blade	\$15.25
LIS-83650	Offset Blade	\$16.45



AST-9532 **\$37⁶⁵**

Tungsten Carbide Gasket Scraper

• 90° Blade edges require no maintenance or sharpening

AP Astro



TITAN

11" Long Carbide Scrapers

Item #	Blade Width	
TIT-17020	5/8"	\$32.75
TIT-17021	1-1/4"	\$44.25



LANG Made in USA

LAN-855-4ST **\$111⁶⁵**

4-Pc Specialty Scraper Set

• Capped handles for striking



GEARWRENCH

GWR-84080H **\$59³⁵**

4-Pc Scraper Set

• 1/4", 1/2", 1" long, 1" short



ATD-63953 **\$86³⁵**

3-Pc Gasket Scraper Set

• 3/4", 1", 1-1/2" blades
• Handles with strike cap



LIS-81200 **\$41⁶⁵**

Plastic Chisel Scraper Set

• The set includes 3/4", 1" and 1-1/2" blade widths



AP Astro

AST-9531 **\$19³⁵**

Universal Razor Edged Scraper and 10 Blades



EZR-MS3000 **\$51⁶⁵**

EZRED

3-Pc Monster Scraper Kit

• Unique angled heads
• 4", 8" and 13" scrapers
• Five spare blades



ATD-7527 **\$16⁸⁵**

4-Pc Scraper Set

• All purpose scraper
• Extended scraper
• 2 Mini scrapers



LIS-52480 **\$13⁹⁵**

4-1/4" Long Retractable Razor Blade Scraper

• Includes 1.5" steel razor blade



TIT-11515 **\$18¹⁵**

12" Long Heavy Duty Scraper

• Reversible 4" stainless steel blade
• Comfort grip with blade storage in handle
• Replacement blades sold separately (#TIT-11516)



TIT-11031 **\$7⁶⁵**

Mini Razor Scraper

• Includes one extra heavy-duty .020" razor blade



TIT-11030 **\$12⁶⁵**

Multi-Purpose Razor Scraper

• Includes one extra heavy-duty .020" razor blade



TIT-17008 **\$23⁹⁵**

22-Pc Multi-Purpose Razor Scraper Set

• (1) 9" Razor scraper
• (11) .020" razor blades
• (10) Non-marring polymer scraper blades



LIS-52000 **\$20²⁵**

Razor Blade Scraper

• Includes five carbon steel blades and one plastic blade
• Handle stores all blades



ATD-8546 **\$13⁶⁵**

Single Edge Razor Blades (#9 Blade)

• Case of 100 blades





Utility Knives

OLF-180 \$4¹⁵
**9mm Multi-Purpose
 Stainless Steel Handle
 Precision Knife**



OLF-SVR-2 \$10¹⁵
**9mm Stainless Steel
 Auto-Lock Precision Knife**



OLF-XA-1 \$8¹⁵
**9mm Fiberglass-
 Reinforced Utility Knife**



OLF-LA-X \$13³⁵
**18mm Fiberglass-
 Reinforced Utility Knife
 with Auto-Lock Slide and
 Multi-Pick**



OLF-SK-4 \$13²⁵
**19mm Semi-Automatic
 Self-Retracting
 Safety Knife**



OLF-XH-AL \$19⁴⁵
**25mm Fiberglass-
 Reinforced
 Utility Knife with
 Auto-Lock Slide**



\$24⁸⁵
OLF-XL-2
**18mm Extended Reach
 Ratchet-Lock Utility Knife**



OLF-L-1 \$10⁶⁵
**18mm Ratchet-Lock Utility
 Knife with ABS Handle**



OLF-L-2 \$12⁵⁵
**18mm Ratchet-Lock Utility
 Knife with ABS Handle &
 Rubber-Grip Insert**



OLF-L-5 \$13³⁵
**18mm Fiberglass-
 Reinforced Utility Knife with
 Ratchet-Lock and Multi-Pick**



OLF-H-1 \$16⁷⁵
**25mm Ratchet-Lock
 Utility Knife with Rubber
 Grip Insert**



OLF-XH-1 \$19⁴⁵
**25mm Extra Heavy Duty
 Fiberglass-Reinforced
 Ratchet-Lock Utility Knife**



OLF-SK-16 \$16³⁵
**Quick-Change
 Concealed Blade
 Safety Knife**
 • Metal tip for improved tape splitting



OLF-PK-1 \$5²⁵
Disposable Bag Cutter
 • Ultra-sharp blade cuts many
 types of bags including foil, glassine,
 nylon, paper, plastic, retort, Tyvek,
 vacuum sealed, and more



Item #	Size	Type	Blade Description	Qty	
OLF-AB-10B	9mm	Snap-Off	Precision Silver	10	\$6.15
OLF-AB-50B	9mm	Snap-Off	Precision Silver	50	\$23.35
OLF-AB-10S	9mm	Snap-Off	Precision Stainless Steel	10	\$8.55
OLF-AB-50S	9mm	Snap-Off	Precision Stainless Steel	50	\$32.65
OLF-ABB-10B	9mm	Snap-Off	Precision Ultra-Sharp Black	10	\$7.15
OLF-ABB-50B	9mm	Snap-Off	Precision Ultra-Sharp Black	50	\$26.85
OLF-LB-10B	18mm	Snap-Off	Heavy-Duty Silver	10	\$8.15
OLF-LB-50B	18mm	Snap-Off	Heavy-Duty Silver	50	\$31.65
OLF-LBB-10B	18mm	Snap-Off	Heavy-Duty Ultra-Sharp Black	10	\$9.35
OLF-LBB-50B	18mm	Snap-Off	Heavy-Duty Ultra-Sharp Black	50	\$36.05
OLF-HB-5B	25mm	Snap-Off	Super Heavy-Duty Silver	5	\$8.75
OLF-HB-20B	25mm	Snap-Off	Super Heavy-Duty Silver	20	\$29.85
OLF-HBB-5B	25mm	Snap-Off	Super Heavy-Duty Ultra-Sharp Black	5	\$10.05
OLF-HBB-20B	25mm	Snap-Off	Super Heavy-Duty Ultra-Sharp Black	20	\$34.35
OLF-LSOL-10B	18mm	Solid	Heavy-Duty Silver	10	\$9.15
OLF-HSWB-1/1B	25mm	Solid	Pull-Saw Blade	1	\$17.15
OLF-LH-20B	18mm	Snap-Off	Hook Blade	5	\$9.45
OLF-SKB-16/10			Quick-Change Concealed Blade Replac. Head for #OLF-SK-16	10	\$26.45



Refill Blades

Made in Japan

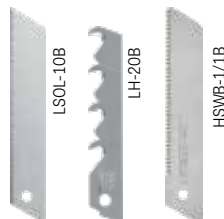
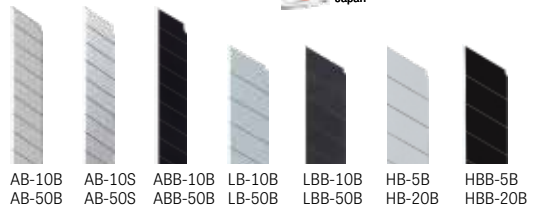

SKB-16/10

KNIVES, SCISSORS & ACCESSORIES

Utility Knives

IRW-2089100 **\$23³⁵**

Folding Utility Knife

- Quick change button
- Wire stripper notch • Anchored belt clip
- Includes (1) IRWIN BLUE BLADE™ bi-metal utility blade



IRWIN

Folding Utility Knives

- Quick change blade
- Folding lock for safety
- Easy carry belt clip
- Includes 5 extra blades with dispenser



TITAN

Item #	Colour	
TIT-11015	Red	\$12.05
TIT-11018	Blue	\$12.05

ATD-8802 **\$17⁵⁵**

Folding Utility Knife

- 4" folded length; 6-1/4" unfolded length
- Uses most standard utility knife blades

ATD



DEWALT

DEW-DWHT10295 **\$21⁶⁵**

Premium Retractable Utility Knife

- Easy blade change with the simple press of a button
- Capable of storing 5 blades in the handle



STANLEY

STN-STHT10424 **\$9³⁵**

Compact Fixed Blade Folding Knife

- Metal body for durability
- Belt clip for convenient portability
- Includes (1) #11-921 heavy duty utility blade



IRWIN

IRW-2084100 **\$3¹⁵**

Bi-Metal ShatterProof Utility Blades

- Pack of 5
- Stays sharp 3X longer than traditional carbon blades



TITAN

TIT-11034 **\$4¹⁵**
10-Pc Standard Utility Knife Blades



STANLEY

Heavy Duty Utility Blades

- Compatible with most standard utility knives

Item #	Quantity	
STN-11-921	5	\$2.45
STN-11-921L	50	\$22.15



ATD

ATD-8813 **\$37¹⁵**
100 Utility Knife Blades in Safety Dispenser

- Type 92 blade, .024" thick heavy-duty high carbon steel blades
- Designed for general purpose cutting
- Fits most standard utility knives



Scissors & Shears

KNI-95 05 155 SBA **\$45⁵⁵**

6-1/8" Electricians' Shears with Plastic Belt Pouch

- Cutting edge with integrated cable cutter

KNIPEX



Heavy Duty Scissors

- Blades with micro teeth
- #905 070 with cable cutter

MULLER KUBIK



Item #	Size	
MUK-905 070	7"	\$33.95
MUK-905 080	8"	\$36.35

OLFA

OLF-SCS-2 **\$35⁹⁵**
7" Stainless Steel Serrated Edge Scissors



TITAN

TIT-12345 **\$25⁹⁵**
7-1/2" Multi-Purpose Shears

- Spring-loaded handles





EV & HEV Service Tools & Equipment



WIH-32800

80-Pc Insulated Tool Set in Rolling Tool Case

- Screwdrivers:
 - Slotted: 2.5mm – 10mm
 - Phillips: #0, #1, #2, #3
 - Torx®: T6-T30
 - Square: #1, #2
 - Terminal block: #1, #2
- Nut drivers: 7/32" – 7/16", 5mm – 13mm
- Sockets: 1/2" – 7/8", 13mm – 22mm
- T-Handles: 5/32" – 3/8", 4 – 8mm • L-keys: 1/2" & 10mm • Pliers • Cutters
- 3/8" Drive ratchet • Extension: 3/8" x 5" • Cable knife: 2" (50mm)
- 2 Meter ruler: inch/metric • Category IV voltage detector: 110V to 250V
- Rolling water tight tool case: 22" L x 13-3/4" W x 9" H



Each item in this set can also be purchased separately.

WIH-91890

\$795¹⁵



26-Piece Insulated Essentials Tool Kit

- Screwdrivers:
 - Slotted: 3.5mm, 4.5mm, 6.5mm
 - Phillips: #1, #2
 - Torx®: T20, T25, T30
- 1/4" drive, 6 pt. sockets: 5-13mm
- 1/4" drive ratchet • 2" & 4" extension bars
- Open end wrenches: 8mm-13mm • 8" Tweezers
- 3-Pc pliers/cutters • 8.5" Cable stripping knife



Each item in this set can also be purchased separately.

WIH-32876

66-Pc Insulated Tool Set

- Screwdrivers:
 - Slotted: 2mm-10mm
 - Phillips: #0, #1, #2, #3
 - Torx®: T8-T30
 - Square: #1, #2
 - Terminal block: #1, #2
- Nut drivers: 1/4" – 7/16"
- Sockets: 1/2" – 7/8", 8 – 22mm
- Hex T-Handles: 5/32" – 3/8", 4 – 8mm
- Hex L-keys: 1/2" & 10mm
- Pliers • Cutters
- Adjustable wrench
- Ratchet: 3/8" drive
- Extension: 3/8" x 5"
- Cable knife: 2" (50mm)



Each item in this set can also be purchased separately.

16-Pc 3/8" Drive Insulated Ratcheting Torque Wrench and Socket Sets

- Torque wrench: 4-37 ft-lb (5-50 Nm)
- Metric or SAE sockets
- Extension bars: 5" & 10"

Item #	Sockets	Range
WIH-30190	SAE	1/4"-7/8"
WIH-30192	Metric	8-20mm



Each item in this set can also be purchased separately.

KNI-98 33 50

\$979⁰⁵

3/8" Drive 15" Long Reversible Torque Wrench, 1000V Insulated

- Transparent scale range: 5-50 Nm
- Lockable torque adjustment



KNI-98 55

\$101²⁵

1000-Volt Insulated Electrician's Dismantling Knife, 7" Long

- 1.5" fixed hook blade with guide shoe at the blade point: no damage of the conductor insulation



TIT-66100

\$358⁸⁵

18-Pc 1/4" Drive Metric Socket Set, 1000V Insulated

- (13) Sockets: 4-14 mm
- Extensions: 2", 3", 4", 6"
- 1/4" drive reversible ratchet with quick release



TITAN

KNI-98 99 11

\$1385³⁵

17-Pc Compact Tool Set, 1000V Insulated

- 8" Combination pliers
- 6-1/4" Diagonal cutters
- 7-1/4" Cable knife
- Slotted screwdrivers: 1/8", 5/32", 7/32"
- Phillips® screwdriver: #0
- 1/2" Drive reversible ratchet
- 1/2" Drive Hex socket set: 10mm-19mm
- Extensions: 5", 10"



WIH-31391

\$590⁷⁵

13-Pc 1/4" Drive Insulated Metric Socket Set

- Sockets: 5mm – 14mm
- Extensions: 2", 4"
- 1/4" Drive reversible ratchet



Each item in these sets can also be purchased separately.

WIH-31590

\$590⁷⁵

10-Pc 3/8" Drive Insulated Metric Socket Set

- Sockets: 8mm – 19mm
- Extension: 5"
- 3/8" Drive reversible ratchet



Each item in this set can also be purchased separately.

Insulated T-Handle Hex Screwdriver Sets

Item #	Set	
WIH-33478	5-Pc 4mm-10mm	\$89.15
WIH-33490	6-Pc 5/32"-3/8"	\$105.75

33478



WIH-20196

\$664⁶⁵

13-Pc Insulated Open End Wrench Tray Set

- 8mm-24mm



Each item in this set can also be purchased separately.

eSHOK-GUARD™ – 1000V Socket Isolator

- Withstands impact applications

Item #	Drive	
CRE-CAEAD316	1/4"	\$18.95
CRE-CAEAD324	3/8"	\$20.45
CRE-CAEAD332	1/2"	\$21.95



EV & HEV Service Tools & Equipment

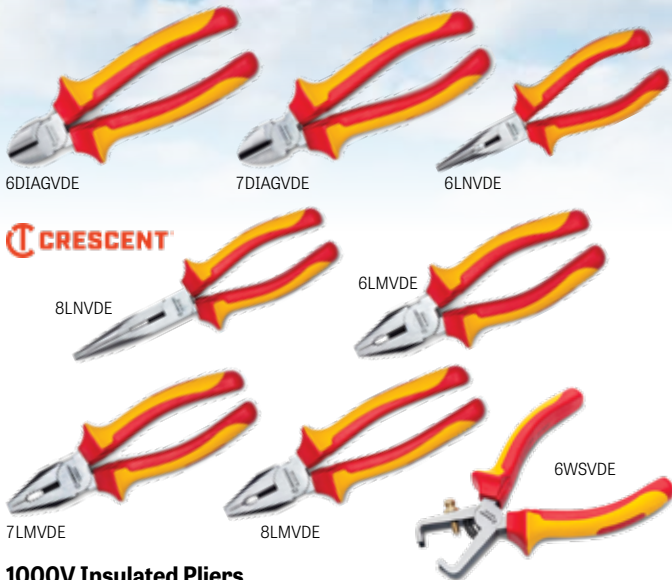

1000V Insulated Pliers

Item #	Description	
Diagonal Cutting Pliers		
CRE-6DIAGVDE	6" 1000V Insulated Diagonal Pliers	\$22.05
CRE-7DIAGVDE	7" 1000V Insulated Diagonal Pliers	\$23.35
Long Nose Pliers		
CRE-6LMVDE	6" 1000V Insulated Long Nose Pliers	\$22.05
CRE-8LNVDE	8" 1000V Insulated Long Nose Pliers	\$25.95
Linesman Pliers		
CRE-6LMVDE	6" 1000V Insulated Linesman Pliers	\$22.05
CRE-7LMVDE	7" 1000V Insulated Linesman Pliers	\$23.35
CRE-8LMVDE	8" 1000V Insulated Linesman Pliers	\$25.95
Wire Stripper Pliers		
CRE-6WSVDE	6" 1000V Insulated Wire Stripper Pliers	\$22.05

TITAN



1000V Insulated Pliers

Item #	Description	
Diagonal Cutting Pliers		
TIT-73346	6" Diagonal Pliers, 1000V Insulated	\$29.65
TIT-73347	7" Extended Diagonal Pliers, 1000V Insulated	\$32.05
TIT-73348	8" Extended Diagonal Pliers, 1000V Insulated	\$34.15
Long Nose Pliers		
TIT-73336	6" Long Nose Pliers, 1000V Insulated	\$29.65
TIT-73338	8" Long Nose Pliers, 1000V Insulated	\$33.65
Linesman Pliers		
TIT-73326	6" Combination Linesman's Pliers, 1000V Insulated	\$29.65
TIT-73327	7" Combination Linesman's Pliers, 1000V Insulated	\$31.65
TIT-73328	8" Combination Linesman's Pliers, 1000V Insulated	\$34.15

TITAN



7-Pc Insulated Screwdriver Set with Magnetic Tips

- Slotted: 1/8" x 3", 5/32" x 4", 7/32" x 5", 1/4" x 6"
- Phillips: #0 x 3", #1 x 4", #2 x 4"

TIT-17237 **\$39³⁵**



wiha



\$363⁹⁵

WIH-28789

11-Pc Insulated TorqueVario-S Driver & SlimLine Blade Set

- TorqueVario-S driver: 10-50 in-lb
- Insulated blades: Slotted: 4mm, 6.5mm; Phillips: #1, #2; Square: #1, #2; Xeno: Terminal #1, #2

7-Pc VDE 1000V Insulated Screwdriver Set

- Slotted: 1/8" x 3", 5/32" x 4", 7/32" x 5", 1/4" x 6"
- Phillips: #0 x 3", #1 x 3", #2 x 4"

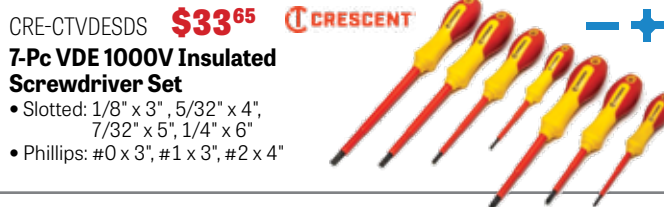

WIH-32999 **\$425⁷⁵**

9-Pc Insulated Pliers/Cutters Tray Set

- Assorted pliers including: lineman's pliers, long nose, diagonal cutters, stripping pliers, crimping pliers, cable cutter



Each item in this set can also be purchased separately.



1000 Volt-Rated Insulated Wire Stripper/Cutter, 8"

- Strips and cuts: 8-16 AWG solid, 10-18 AWG stranded
- Screw shearing: #6-32 and #8-32





EV & HEV Service Tools & Equipment

MLW-48-22-2202 **\$35¹⁵**

3-Pc 1000V Insulated Screwdriver Set

- ECX™: #1 x 4"
- Phillips: #2 x 4"
- Slotted: 1/4" x 6"



MLW-48-22-2205 **\$55⁶⁵**

4-Pc 1000V Insulated Screwdriver Set

- Slotted: 1/4" and 3/8" (6" and 8" long)
- Square: #1 and #2 (3" and 4" long)



MLW-48-22-2210 **\$226²⁵**

10-Pc 1000V Insulated Screwdriver Set

- ECX™: #1 x 4"
- Phillips: #1 x 3", #2 x 4", #3 x 6"
- Slotted: 1/4" x 6", 5/16" x 7", 3/8" x 8"
- Square: #1 x 3", #2 x 4", #3 x 6"



CTU-ALPV-XL-D **\$172⁴⁵**

Locking Cover for Steering Wheel

- Up to 24.4" (62 cm)
- Transparent pocket (A5 size) allows to display a personalized message during the lock-out procedure
- Strap closure at the back with 10mm metal eyelets for inserting a padlock and self-gripping part



CTU-MP-11/11 **\$169¹⁵**

Insulating Mat - Class 0

- Insulating mat for live line work and dead work
- 3.3 ft. x 3.3 ft. (1m x 1m)
- Thickness: 2.2mm
- Operating voltage: 1000V AC - 1500V DC

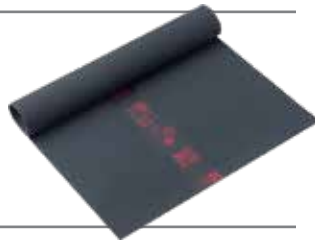

CTU-MP-220 **\$209⁰⁵**

Orange Insulating Blanket - Class 0

- Used as protection for workers operating on live lines, live parts or in the vicinity of live parts
- 3.3 ft. x 3.3 ft. (1m x 1m)
- Thickness: 1.2mm
- Operating voltage: 1000V AC - 1500V DC
- Oil resistance and high puncture resistance



KNI-98 67 05 **\$177⁶⁵**

20" x 20" Rubber Mat, 1000V Insulated

- For added protection when working live or close to live parts
- Thickness: 1/16" (1.58mm)



Insulating Blanket - Class 0

- Used as protection for workers operating on live parts or in the vicinity of live parts
- Operating voltage: 1,000V AC - 1,500V DC
- Acid and oil resistance
- High puncture resistance
- Gripping tape ("Velcro" type) all around the blanket for fixation or fitting with another blanket
- Operating temp. range: -40°C to +55°C

Item #	Description	
CTU-MP-123	14" x 26" (360mm x 660mm)	\$43.15
CTU-MP-123/1	19.5" x 35.5" (500m x 900mm)	\$72.95
CTU-MP-123/2	31.5" x 47" (800mm x 1,200mm)	\$155.85



MP-35
ML-35/12



MP-37

Insulating Transparent & Flexible PVC Blanket - Class 0

- Insulating blanket for workers operating on live parts or in the vicinity of live parts
- Operating voltage: 1,000 V AC - 1,500 V DC
- Must be fixed with MP-41A70 insulating magnets or MP-41-..., or MP-62.D clamps
- Resistance to acid, oil and ozone
- Operating temp. range: -40°C to +55°C

Item #	Description	
CTU-MP-35	4.25 ft. x 82 ft. (1.3m x 25m)	\$567.15
CTU-MP-35/12	4.25 ft. x 41 ft. (1.3m x 12.5m)	\$301.75
CTU-MP-37	3.5" x 82 ft. (90mm x 25m)	\$63.05

EV & HEV Service Tools & Equipment

AC WALLBOX HOME



Mobile device or computer not included

AC WALLBOX COMMERCIAL



AUTEL® MAXICHARGER™

AC Wallbox Level 2 Electric Vehicle Chargers

- Compatible with all EV & plug-in hybrid vehicles
- Indoor/Outdoor use, built to withstand any type of climate
- Level 2 chargers require 240V
- Up to 9X faster charge
- Dimensions: 7.36" x 13.22"
- Generous 25-foot cable
- Safe & secure access control
- Connect by Wi-Fi, Bluetooth, Ethernet, CAN, RS485 or 4G Cellular (4G Cellular works with the Commercial unit only)
- 4 LED lights on face of charger clearly indicate the status of your charger
- 24/7 customer support line
- Automatic firmware updates
- Includes 3 year warranty
- **AC WALLBOX HOME Smart Charging:**
The Autel Mobile Charge App enables remote start, stop, monitoring and scheduling. Available at App Store or Google Play.
- **AC WALLBOX COMMERCIAL Smart Charging:**
Smart charger capabilities with Autel Cloud Charging Portal to monitor and manage all chargers and control access from your computer or mobile device. This allows you to control station access, pricing along with hours of operation. Smart features like demand response and dynamic load balancing help with reducing operation costs.

MAXICHARGER®

Product	Item #	Power Output	Power Supply	Holster	Front Face	Wi-Fi	Mobile App	Internet-Based Commercial Portal	
	AUL-MC40AP14S HOME	Adjustable up to 40 Amps 9.6 kW	NEMA 14-50 Plug 	Separate	Indicator Lights Only	✓	✓		\$870.05
	AUL-MC40AP6S HOME	Adjustable up to 40 Amps 9.6 kW	NEMA 6-50 Plug 	Separate	Indicator Lights Only	✓	✓		\$870.05
	AUL-MC50AHS HOME	Adjustable up to 50 Amps 12 kW	HARDWIRED*	Separate	Indicator Lights Only	✓	✓		\$870.05
	AUL-MC40AP14I HOME	Adjustable up to 40 Amps 9.6 kW	NEMA 14-50 Plug 	In-Body	Indicator Lights Only	✓	✓		\$870.05
	AUL-MC40AP6I HOME	Adjustable up to 40 Amps 9.6 kW	NEMA 6-50 Plug 	In-Body	Indicator Lights Only	✓	✓		\$870.05
	AUL-MC50AHI HOME	Adjustable up to 50 Amps 12 kW	HARDWIRED*	In-Body	Indicator Lights Only	✓	✓		\$893.75
	AUL-MCC50AHI COMMERCIAL	Adjustable up to 50 Amps 12 kW & 72 KM of range per hour	HARDWIRED*	In-Body	5" Interactive LCD Touchscreen	✓		✓	\$1270.75

*Recommended hardware for outdoor installation



EV & HEV Service Tools & Equipment



TBQ-4JPT **\$24⁹⁵** 4-Pc Lifting Jack Pads for Tesla Models S, 3, X, Y

- These rubber pads are positioned under the designated Tesla lift points to prevent damage to the battery or the side rails of the vehicle when lifting
- Load capacity (4 pads): 5 ton



CTU-MO-810 **\$411²⁵** Insulating Device To Lift Up Batteries

- To lift up batteries for live working at low voltage
- To lift forklift batteries elements for maintenance operations
- Operating voltage: 1,000 V AC - 1,500 V DC
- Adjustable fixing capacity from 81mm to 118 mm
- Max. load: 507 lbs (230 kg)



HBF-TPOPUV20EV **\$407⁴⁵** POE-Based EV A/C Dye UV Leak Detection Kit

- Compatible with R-1234yf & R-134a
- **TP9815EV-P3:** (3) 0.25 oz (7 ml) cartridges of Electric Vehicle POE-based A/C Dye Mini-EZ™ cartridges
- **TP9845:** EZ-Ject™ dye injector
- **TP-9813:** R-134a coupler and purge fitting
- **TP19:** fluorescent dye cleaner
- **TP9831:** R-1234yf adapter



CTU-CD-307 **\$882¹⁵** Portable Fire Extinguisher for Li-Ion Battery Fire, 3L

- Can be used on batteries with a maximum voltage of 1,000 V AC - 1,500 V DC
- Fire class A • Limits the smoke formation
- Water extinguisher + spray additive, biodegradable
- Projection distance: 4m to 6m • Service life: 10 years



CTU-KIT-VEH **\$1226²⁵** Delineation Kit for Application in the Field of Electric & Hybrid Vehicles and Machines

- (6) Red and white ballasted boundary posts (#AL-323)
- (1) Plastic chain with red and white links, 25m (#AL-31/25)
- (2) Plastic signs, 450mm x 150mm (#AP-72)



Each item in this set can also be purchased separately.



Folding Modular Safety Barrier

- Lightweight and stable 3-panel intervention barrier (AL-325), used to temporarily fence off and delimit a work area
- Light and flexible structure made of PVC tubes and panels made of 100% polyester fabric in fluorescent yellow
- Modularity: possibility to add or remove panels
- AL-326: Additional element made up of a single panel, allowing to enlarge the barrier
- Fixing by 2 junction clips (supplied)
- For indoor use

Item #	Description	Dimensions	
CTU-AL-325	3-Panel Barrier	5.5 ft. x 3.25 ft. (1.71m x 1m)	\$460.95
CTU-AL-326	1 Panel Extension	2 ft. x 3.25 ft. (0.57m x 1m)	\$169.15

CTU-ACA-10 **\$46⁴⁵** "Electric Hazard" Warning Pyramid with Magnetic Base

- For work on HEV or batteries
- Allows an optimum 360° visualization of the electric danger
- Cardboard cone, 5.5" (140mm) side



KLE-58000 **\$20⁵⁵** CAUTION Tape, Barricade

- 3" x 200 feet (76mm x 61m)
- Made of tough, durable (2.5 mil) polyethylene
- Highly resistant to acids, alkalis and other components



EV & HEV Service Tools & Equipment

FLUKE

FLUKE CONNECT

FLU-4691215

Fluke 1587 FC – Insulation Tester & True RMS Multimeter

- PI/DAR timed ratio tests
- Insulation test range: 0.01 MΩ to 2 GΩ
- Insulation test voltages: 50V, 100V, 250V, 500V, 1000V
- Voltage AC/DC: 1000V
- Capacitance, diode test, temp., Min/Max, and frequency
- Continuity: 200 mA • Resistance: 50 MΩ



POWER PROBE



PWP-VT750LCD **\$156⁰⁵**

Two-Pole Voltage Tester for Electric and Hybrid Vehicles

- Safety rated at 1000V CAT III, 600V CAT IV
- Automatically selects the correct voltage range
- AC/DC Volts: 750V • Resistance: 0-2,000Ω • Frequency: 30Hz-999Hz
- Continuity beeper: ≤600KΩ • Diode test: 0.3V-0.9V
- Single phase test voltage: 100-750V

KLEIN TOOLS

KLE-ET600 **\$314⁵⁵**

Insulation Resistance Tester with Multimeter Test Functions

- Test voltages: 125V, 250V, 500V, 1000V
- Insulation resistance: 4000MΩ
- Test lock • Live circuit detection
- AC/DC voltage: 1000V
- Resistance: 4kΩ • True RMS
- Audible continuity
- Auto-ranging, Auto-Zero
- Data hold • Min/Max value
- Bar graph • CAT IV 600V and CAT III 1000V



ES

ESI-550 **\$419¹⁵**

EV & Hybrid Vehicle Insulation Tester

- Test voltages: 250V-200MΩ, 500V-200MΩ, 1000V-2000MΩ
- AC voltage: 0-750V, 1V resolution
- DC voltage: 0-1000V, 1V resolution
- Resistance: 0-200Ω, 2000Ω, 0.1 Ohm resolution
- Insulation resistance: 200MΩ, 2000MΩ, 200k resolution
- Continuity test: Audible beep ≤40Ω, Test current ≤200mA
- Auto-ranging • Large dual display
- Test Hold function • Over Range indication • CAT III 1000V



Personal Protective Equipment



CTU-MO-286 **\$182⁴⁵**
Arc-Flash Protective Face Shield with Headband for Electrician

- To wear without a helmet
- Ratchet head adjustment
- Anti-scratch and anti-fogging treatments
- Visor height: 8" (20.5 cm)



CTU-CS452 **\$409³⁵**
Rescue Stick with Insulated Permanent Hook

- 45 kV
- 1.65m long
- Includes wall brackets (#CI-06-D)

CTU-CZ-EV-RESC **\$1661⁵⁵**

Rescue Wall Kit for Automotive Maintenance and Body Repair Shops

- (1) Rescue stick with insulated hook (#CS-45/2)
- (1) Wall box for insulated gloves (#CG-35-2)
- (1) Pair of rubber insulating gloves, Class 0, 1000V AC / 1500V DC, size 10 (#CGM-0-10)
- (1) Li-ion battery fire extinguisher (#CD-307)



Each item in this set can also be purchased separately.

Each item in this set can also be purchased separately.



CTU-KIT-VEH-DEP **\$955¹⁵**

Head and Hand Protection Kit for Towing Services for Electric and Hybrid Vehicles and Machines

- (1) Arc-Flash protective faceshield with headband and a storage bag (#MO-286)
- (1) Pair of short insulating gloves (28cm), Class 0, 1000V AC / 1500V DC, size 10 (#CG-0-10-R-28)
- (1) Pair of cotton under-gloves (#CG-80-H)
- (1) Pair of short leather overgloves, size 10 (#CG-984-10)
- (1) Bag for protection and storage of gloves (#CG-36-1)
- (40) "DAMAGED VEHICLE" removable stickers (#AT-81)
- (1) Non-conducting safety padlock (#PP-6-38-R-Z)
- (10) Safety Tag-Out badges with warning sign (#AP-460)
- (1) Storage bag (#MO-42/2)

CTU-MV-99-INSD **\$706⁰⁵**

Orange Insulating Apron – Class 0

- Operating voltage: 1000V AC – 1500V DC
- Adjustable belt strap with plastic lock
- Perforation, acid and oil resistant
- Can be folded at very low temp. (-40°C)
- Insulator's H x W: 65 cm x 50 cm • Thickness: 1.2mm

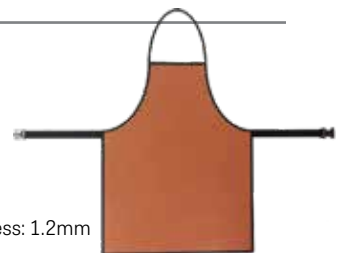



Personal Protective Equipment



Visor, insulated gloves and shoes sold separately

CAT'ARC Multi-Risk Switching Jacket to Protect Against an Electric Arc

- Worn on top of the usual clothing
- Adjustable hood
- To be worn with a visor or a helmet
- Velcro® central fastening along the entire length
- Back length of 47" (121 cm)

Item #	Size	
CTU-AFG-2300-S	S	\$581.85
CTU-AFG-2300-L	L	\$640.05
CTU-AFG-2300-2XL	2XL	\$640.05
CTU-AFG-2300-4XL	4XL	\$581.85



ANSELL GLOVE SIZING CHART

Measure the width of your hand from the base of your index finger and across your knuckles.

7 / S	75mm / 3"
8 / M	88mm / 3.5"
9 / L	101mm / 4"
10 / XL	113mm / 4.5"
11 / 2XL	126mm / 5"
12 / 3XL	140mm / 5.5"

Ansell

No Returns Accepted

100% Natural Rubber Electrical Insulating Gloves

- 11" long gloves
- Ergonomically-designed hand-at-rest shape for less hand fatigue
- Generous flared cuff allows room for clothing and improves ventilation
- Exceeds ASTM D120 standards for tensile strength, elongation, tear & puncture resistance
- Product meets all applicable ASTM, NFPA, OSHA, CSA and EN standards



Red Gloves, Class 0

- Max. use voltage AC/DC 1,000 / 1,500 Volt

Item #	Size	
ANS-RIG011R070	7	\$78.75
ANS-RIG011R080	8	\$78.75
ANS-RIG011R090	9	\$78.75
ANS-RIG011R100	10	\$78.75
ANS-RIG011R110	11	\$78.75
ANS-RIG011R120	12	\$78.75

Yellow Gloves, Class 0

- Max. use voltage AC/DC 1,000 / 1,500 Volt

Item #	Size	
ANS-RIG011Y070	7	\$78.75
ANS-RIG011Y080	8	\$78.75
ANS-RIG011Y090	9	\$78.75
ANS-RIG011Y100	10	\$78.75
ANS-RIG011Y110	11	\$78.75
ANS-RIG011Y120	12	\$78.75

Insulating Waterproof Overboots - Class 1

- Operating voltage: 7,500V AC / 11,250V DC
- Meets the requirements of ASTM 1117 (20kV)
- Fit perfectly over safety shoes
- Fuel and oil resistant rubber sole
- Sole pattern design avoids clogging and catching on rungs when climbing ladders
- Hot contact resistant sole to 300°C for 60 seconds
- Quick and easy to wear & remove



Item #	Size	
CTU-MV-138-M	M (39-42)	\$354.85
CTU-MV-138-L	L (43-45)	\$354.85
CTU-MV-138-XL	XL (46-49)	\$354.85

Leather Overgloves for Low Voltage Insulating Gloves

- 12.5" long. Ensure mechanical protection for insulating gloves (Class 00 & 0).
- Resistant to flame and contact heat of 100°C for 10 seconds according to EN 407

Item #	Size	
CTU-CG-981-08	8	\$87.55
CTU-CG-981-09	9	\$87.55
CTU-CG-981-10	10	\$87.55
CTU-CG-981-11	11	\$87.55



Undergloves for Insulating Gloves

- Comfortable fit, washable cotton undergloves
- Helps protect from Latex allergies

Item #	Fits Size	
CTU-CG-80-F	8	\$14.95
CTU-CG-80-H	9, 10, 11	\$14.95



CTU-CG-36-1 **\$69⁷⁵**

Storage Case for Insulating Gloves - Class 00, 0, 1

- 16.5" x 7" x 2" case made of repellent reinforced fabric for the transportation of insulating gloves
- Rear loop for belt carriage and transparent pocket



CTU-CG-117 **\$357¹⁵**

Pneumatic Tester for Insulating Gloves

- For compulsory control of insulating gloves from class 00 to 4 before use
- Checking is done by inflating the insulating gloves and immersing in water



10" Industrial Leather Protector Gloves - Class 00, 0

- Should always be worn over Rubber Insulating Gloves to meet OSHA and ASTM standards to provide mechanical protection against cuts, abrasions and punctures
- SIZING: These leather gloves **should be ordered in the same size** as the Rubber Electrical Insulating Gloves

Item #	Size	
ANS-RIGLVCVR070	7	\$41.55
ANS-RIGLVCVR080	8	\$41.55
ANS-RIGLVCVR090	9	\$41.55
ANS-RIGLVCVR100	10	\$41.55
ANS-RIGLVCVR110	11	\$41.55
ANS-RIGLVCVR120	12	\$41.55

Ansell



Protective Bag with Clip

- Canvas glove bag is designed for use with Electrical Insulating Gloves

Item #	Size	
ANS-RIGCVSBAG14	14"	\$28.05
ANS-RIGCVSBAG16	16"	\$42.05

Ansell



Fixed Head Ratchets

GEARWRENCH



Full Polish Fixed Head Teardrop Ratchets

Item #	Drive	Handle	Length	Mechanism	
Individual Ratchets					
GWR-81011T	1/4"	Standard	5"	90-tooth	\$42.85
GWR-81028T	1/4"	Long	6"	90-tooth	\$48.95
GWR-81211T	3/8"	Standard	8"	90-tooth	\$64.25
GWR-81264T	3/8"	Long	11"	90-tooth	\$74.95
GWR-81209T	3/8"	Stubby	4.75"	90-tooth	\$55.05
GWR-81220T Compact Head	3/8"	Standard	8"	90-tooth	\$61.15
GWR-81228T Compact Head	3/8"	Stubby	4.5"	90-tooth	\$53.55
GWR-81304T	1/2"	Standard	11"	90-tooth	\$79.55
GWR-81360T	1/2"	Long	15"	90-tooth	\$119.05
GWR-81011P	1/4"	Standard	5"	120^{XP}	\$45.85
GWR-81034	1/4"	X-Long	9"	120^{XP}	\$56.65
GWR-81211P	3/8"	Standard	8"	120^{XP}	\$68.85
GWR-81269	3/8"	X-Long	18"	120^{XP}	\$91.75
GWR-81304P	1/2"	Standard	11"	120^{XP}	\$85.65
GWR-81364	1/2"	X-Long	24"	120^{XP}	\$130.05
Ratchet Sets					
GWR-81206T	3-Piece 1/4", 3/8", 1/2"	Standard	5", 8", 11"	90-tooth	\$168.35
GWR-81268T	2-Piece 1/4", 3/8"	Long	6", 11"	90-tooth	\$107.15
GWR-81253T	2-Piece 3/8" & 3/8"	Standard & Stubby	8", 4.5"	90-tooth	\$121.25
GWR-81206P	3-Piece 1/4", 3/8", 1/2"	Standard	5", 8", 11"	120^{XP}	\$195.95
GWR-81271	2-Piece 1/4", 3/8"	X-Long	9", 18"	120^{XP}	\$145.35

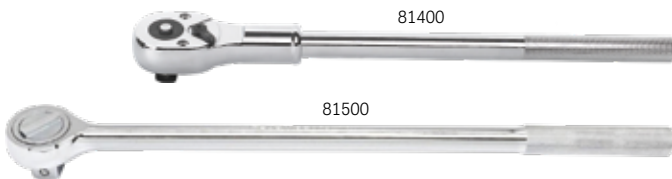

GWR-81400 **\$160⁶⁵**
3/4" Drive 20" Long Quick Release Ratchet
 • 24-tooth

GWR-81500 **\$248⁷⁵**
1" Drive 25" Long Round Head Ratchet
 • 24-tooth

GEARWRENCH



Cushion Grip Fixed Head Teardrop Ratchets

Item #	Drive	Handle	Length	Mechanism	
Individual Ratchets					
GWR-81007T	1/4"	Standard	6"	90-tooth	\$53.55
GWR-81029T	1/4"	Long	8"	90-tooth	\$56.65
GWR-81208T	3/8"	Standard	9"	90-tooth	\$99.45
GWR-81265T	3/8"	Long	13"	90-tooth	\$81.05
GWR-81303T	1/2"	Standard	11"	90-tooth	\$122.45
GWR-81361T	1/2"	Long	16"	90-tooth	\$114.75
Ratchet Sets					
GWR-81207T	3-Piece 1/4", 3/8", 1/2"	Standard	6", 9", 11"	90-tooth	\$203.55

Astro



Nano Ratchets

- Smaller head size
- 72 tooth mechanism

Item #	Drive	Length	
AST-91410	1/4"	10"	\$33.75
AST-93808	3/8"	8"	\$27.45
AST-93812	3/8"	12"	\$42.25
AST-91210	1/2"	10"	\$35.75

TITAN



Sealed Head Ratchets

- 90 tooth mechanism

Item #	Drive	Length	
TIT-12160	1/4"	6"	\$43.55
TIT-12161	3/8"	12"	\$62.45
TIT-12162	1/2"	16"	\$86.85

Quick-Release Offset Ratchets

- Contoured cushion grip handle



Item #	Drive	Length	Mechanism	
TIT-12042	1/4"	5-3/4"	72 tooth	\$20.95
TIT-12043	3/8"	8"	72 tooth	\$23.35
TIT-12044	1/2"	9-3/4"	72 tooth	\$31.35
TIT-12046	1/2"	15"	36 tooth	\$44.65

TIT-18025 **\$70⁷⁵**
3-Pc Quick-Release Offset Ratchet Set
 • 1/4", 3/8", 1/2" drives
 • 5.5", 8", 10"



Fixed Head Ratchets



TIT-12050 \$20⁹⁵
1/4" and 3/8" Dual Drive Stubby Ratchet
 • 72 tooth mechanism



TIT-12103 \$22¹⁵
1/4" and 3/8" Dual Drive Mini Ratchet
 • 3" long

TITAN



Gearless Micro Ratchets

TITAN

Item #	Drive	Length	
TIT-11200	1/4"	3"	\$33.95
TIT-11201	3/8"	4"	\$37.95
TIT-18202	2-Pc Set: 1/4" & 3/8"	3" & 4"	\$72.15

TIT-11203 \$39³⁵
2-Pc Offset Micro Bit Driver and Ratchet Set
 • 1/4" drive ratchet
 • Bit driver with #2 Phillips bit • 3.5" long



TIT-11206 \$20³⁵
1/4" Drive Offset Micro Ratchet
 • 3.5" long



TIT-11207 \$20³⁵
Offset Micro Bit Driver
 • Includes (1) #2 Phillips bit • 3.5" long



2" Long Dual Drive Ratchets

- For use with extensions and other tools
- 60 tooth mechanism
- Thumb wheel for finger tip control

VIM

Item #	Drive	
VIM-DD2	1/4"	\$61.75
VIM-DD3	3/8"	\$72.65



Mixed Ratchet Sets

GWR-81203T \$271³⁵
3-Pc 90-Tooth Cushion Grip Mixed Teardrop Ratchet Set
 • 1/4" drive, 6" ratchet
 • 3/8" drive, 9" ratchet
 • 3/8" drive, 13" flex head ratchet



TIT-12175 \$344⁷⁵
5-Pc 90-Tooth Mixed Ratchet Set
Sealed head ratchets:
 • 1/4", 3/8", 1/2 drives
 • 6", 12", 16"
Swivel head ratchets:
 • 1/4" drive – 6-1/2"
 • 3/8" drive – 10"



Flex Head Ratchets

Astro

AST-78318 \$39⁷⁵
18" Extra-Long 3/8" Drive Flex Head Nano Socket Ratchet Wrench

- Designed to work with and retain stubby Nano style stubby impact sockets such as Astro #78319 for a full working height of just 0.88"
- 100-tooth ratcheting mechanism
- Retains 3/8" drive size stubby Nano style sockets with 17mm outside hex



GWR-81032 \$107¹⁵
45-Pc 1/4" Drive 6 Point Standard Metric Tool Set

- 6" & 12" slim head locking flex head ratchets
- 4" extension
- 4mm-13mm sockets
- 30 piece screwdriver bit box



EZR-MMS14 \$51³⁵
20-Pc 1/4" Drive Mini Master Set

- 1/4" flex head ratchet with bit holder end
- (8) Spline low profile metric sockets (4-11mm)
- (10) Bits, 3" extension, nylon roll-up pouch



GWR-81229T \$142³⁵
3-Pc 3/8" Drive Spark Plug Ratchet Set

- Includes 6" magnetic swivel spark plug sockets: 5/8" and 13/16"
- 90-tooth



Locking 180° Flex Head Full Chrome Ratchets

Item #	Drive	Length	
EZR-MR3818FL	3/8"	16-3/4"	\$83.75
EZR-MR1224FL	1/2"	22"	\$152.55

EZRED

Flex Head Ratchets

Item #	Drive	Length	
MLW-48-22-9007	1/4"	6"	\$62.35
MLW-48-22-9009	1/4"	9"	\$72.65
MLW-48-22-9039	3/8"	9"	\$87.35
MLW-48-22-9041	3/8"	12"	\$100.85
MLW-48-22-9051	1/2"	11"	\$114.05
MLW-48-22-9052	1/2"	18"	\$127.55

Milwaukee



Flex Head Ratchets

GW GEARWRENCH

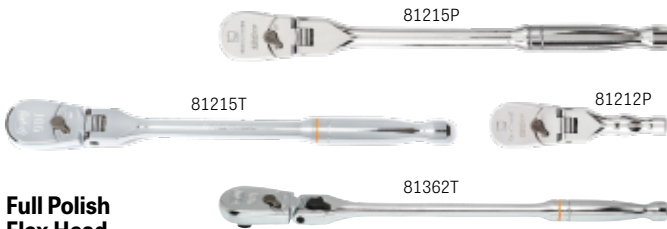

Full Polish Flex Head Teardrop Ratchets

Item #	Drive	Handle	Length	Mechanism	
Individual Ratchets					
GWR-81015T	1/4"	Locking Flex	7"	90-tooth	\$56.65
GWR-81012T	1/4"	Flex	7"	90-tooth	\$50.45
GWR-81266T	3/8"	Locking Flex	11"	90-tooth	\$91.75
GWR-81215T	3/8"	Flex	11"	90-tooth	\$76.45
GWR-81212T	3/8"	Stubby Flex	5"	90-tooth	\$70.35
GWR-81362T	1/2"	Locking Flex	17"	90-tooth	\$119.35
GWR-81363T	1/2"	Locking Flex	24"	90-tooth	\$153.05
GWR-81306T	1/2"	Flex	17"	90-tooth	\$91.75
GWR-81012P	1/4"	Flex	7"	120 ^{XP}	\$53.55
GWR-81215P	3/8"	Flex	11"	120 ^{XP}	\$91.75
GWR-81212P	3/8"	Stubby Flex	5"	120 ^{XP}	\$73.45
GWR-81306P	1/2"	Flex	17"	120 ^{XP}	\$127.65
Ratchet Sets					
GWR-81216T	2-Piece 1/4", 3/8"	Flex	7", 11"	90-tooth	\$122.45
GWR-81230T	4-Piece 1/4", 3/8", 3/8", 1/2"	Flex	5", 7", 11", 17"	90-tooth	\$211.05
GWR-81274T	2-Piece 1/4", 3/8"	Locking Flex	7", 11"	90-tooth	\$125.45
GWR-81276T	3-Piece 1/4", 3/8", 1/2"	Locking Flex	7", 11", 17"	90-tooth	\$226.15
GWR-81230P	4-Piece 1/4", 3/8", 3/8", 1/2"	Flex	5", 7", 11", 17"	120 ^{XP}	\$301.55

GW GEARWRENCH



Cushion Grip Flex Head Teardrop Ratchets

Item #	Drive	Handle	Length	Mechanism	
Individual Ratchets					
GWR-81016T	1/4"	Locking Flex	8"	90-tooth	\$55.05
GWR-81009T	1/4"	Flex	8"	90-tooth	\$64.25
GWR-81267T	3/8"	Locking Flex	13"	90-tooth	\$125.45
GWR-81210T	3/8"	Flex	13"	90-tooth	\$91.75
GWR-81213T	3/8"	Off-Set Flex	12"	90-tooth	\$114.75
GWR-81371T	1/2"	Locking Flex	17"	90-tooth	\$122.45
GWR-81372T	1/2"	Locking Flex	24"	90-tooth	\$183.65
GWR-81370T	1/2"	Flex	17"	90-tooth	\$100.95
GWR-81009P	1/4"	Flex	8"	120 ^{XP}	\$67.35
GWR-81210P	3/8"	Flex	14"	120 ^{XP}	\$99.45
Ratchet Sets					
GWR-81204T	2-Piece 1/4", 3/8"	Flex	8", 13"	90-tooth	\$153.05
GWR-81275T	2-Piece 1/4", 3/8"	Locking Flex	8", 13"	90-tooth	\$183.65
GWR-81298T	3-Piece 1/4", 3/8", 1/2"	Locking Flex	8", 13", 17"	90-tooth	\$226.15
GWR-81204P	2-Piece 1/4", 3/8"	Flex	8", 14"	120 ^{XP}	\$183.65

Rotating Head Ratchets

GW GEARWRENCH



Roto Ratchet

- 360° rotating head • 72 tooth mechanism

Item #	Drive	Length	
GWR-81224	1/4"	6-3/4"	\$61.15
GWR-81225	3/8"	9-3/4"	\$84.15
GWR-81223	2-Pc Set: 1/4" & 3/8"		\$110.15

TITAN

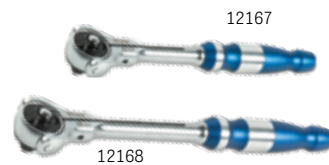

Swivel Head Ratchets

- 90 tooth mechanism

Item #	Drive	Length	
TIT-12167	1/4"	6.5"	\$71.75
TIT-12168	3/8"	10"	\$91.05



1/4" Drive Aluminum Swivel Head Micro Ratchets

- 4" long • 90 tooth mechanism

Item #	Colour	
TIT-11316	Blue	\$33.85
TIT-11320	Red	\$33.85
TIT-11322	Orange	\$33.85

TITAN



\$47⁹⁵

TIT-11328

1/4" Drive Extended Reach Swivel Head Reversible Micro Ratchet

- 7" long
- 90 tooth mechanism

Extendable Ratchets



VIM-HDR34K **\$433²⁵** **NEW**

3/4" Drive Heavy-Duty Extendable Ratchet and Breaker Bar Kit

- Extends from 29" to 40"
- Includes a handle, ratchet head and breaker bar head



Extendable Full Chrome Ratchets



Item #	Drive	Extension	
EZR-MR34	3/4"	24" - 40"	\$243.65
EZR-MR1X	1"	24" - 40"	\$413.75



Extendable Ratchets

Item #	Drive	Extension	
EZR-MR14	1/4"	6.89" - 8.85"	\$42.45
EZR-MR38	3/8"	9.84" - 13.78"	\$60.45
EZR-MR12	1/2"	13.78" - 19.79"	\$72.35
EZR-MR482	3-Pc Set 1/4", 3/8", 1/2"		\$149.85



Locking 180° Flex Head Extendable Ratchets



Item #	Drive	Extension	
EZR-MR14FL	1/4"	6.89" - 8.85"	\$56.75
EZR-MR38FL	3/8"	9.84" - 13.78"	\$66.75
EZR-MR12FL	1/2"	13.78" - 19.79"	\$91.65
EZR-MR482FL	3-Pc Set 1/4", 3/8", 1/2"		\$210.95

TITAN

TIT-12071 **\$30⁶⁵**

1/4" and 3/8" Drive Stubby Extendable Ratchet

- Extends from 6-1/2" to 9" in length
- 72 tooth mechanism



TIT-12069 **\$36⁹⁵**

3/8" Drive Extendable Reversible Ratchet

- Extends from 8.5" to 12.8" in length
- 72 tooth mechanism
- Handle locks into 4 positions



1/4" Square Drive Ratchets



VIM-HBR12 **\$100⁵⁵**

12" Long 1/4" Hex Bit Flex Head Ratchet Wrench

- Removable 1/4" square drive adapter
- Works with all 1/4" Hex bits & 1/4" drive sockets

EZR-4S04 **\$70⁹⁵**

4" Long Quarter Stick Ratchet

- 1/4" square socket and 1/4" magnetic bit drives
- Reversible
- Push-button quick release
- 180° flex heads for multiple angles



EZR-4SS8 **\$65²⁵**

8" Long S-Shaped Quarter Stick Ratchet

- 1/4" square socket and 1/4" magnetic bit drives
- Reversible • Requires only 5" to move fasteners



EZR-4S12L **\$85⁹⁵**

12" Locking Flex Head Quarter Stick Ratchet

- 1/4" square socket and 1/4" magnetic bit drives
- Reversible • Push-button quick release
- 180° flex heads lock in 10 different positions

SUNEX[®] TOOLS

SUN-9728 **\$38³⁵**

1/4" Drive Mini Magnetic Ratcheting Bit Driver



VIM

VIM-HBR4 **\$29⁰⁵**

1/4" Hex Bit Ratchet



LANG[®] TOOLS



LAN-5221 **\$34³⁵**

5-Pc Fine Tooth Bit Driver Set

- (1) 15° offset wrench
- Bit Sizes: #1 & #2 Phillips; 1/4" and 9/32" Slotted
- Use with any 1/4" drive bit as a ratcheting screwdriver or a 1/4" adapter



TIT-11317 **\$33⁸⁵**

4" Long 1/4" Drive Aluminum Swivel Head Micro Bit Driver

- 90-tooth
- Magnetic bit retention
- Includes PH2 bit



SOCKETS, BIT SOCKETS & ACCESSORIES

Chrome Sockets

ATD-1380 **\$415⁹⁵**
106-Pc 6 Point 1/4" & 3/8" SAE/Metric Shallow & Deep Master Socket Set

- 1/4" Shallow: 3/16" to 1/2", 4mm to 12mm
- 1/4" Deep: 3/16" to 1/2"
- 3/8" Shallow: 3/8" to 7/8", 8mm to 19mm
- 3/8" Deep: 3/8" to 7/8", 8mm to 19mm
- (2) Ratchets • (4) Wobble extensions • (3) Spark plug sockets
- (2) Adapters • (2) Universal joints • (2) Flex handles
- Bits: (3) Slotted, (4) Phillips, (6) Hex & (7) Torx®



VIM-10X10 **\$89³⁵**
10-Pc 1/4" & 3/8" Drive 10mm Master Socket Set

- Set includes every type of 10mm socket you might need for any kind of job. Low-profile dual-drive sockets for tight spaces, deep sockets for extra reach and impact rated sockets.
- Includes stubby spring loaded Universal Joint, 10mm and Square Drive



6 120XP™ Locking Flex Head Ratchet and 6 Point STUBBY Socket Mechanics Tool Sets

- Sets include:
 • Extensions: 3" & 6" • Universal joint

Item #	Piece Count	Drive	Size Range	Ratchet length	
GWR-81390	15-Pc	1/4"	4mm – 14mm	7"	\$127.35
GWR-81391	14-Pc	1/4"	3/16" – 9/16"	7"	\$127.35
GWR-81392	18-Pc	3/8"	6mm – 19mm	13.5"	\$181.65
GWR-81393	16-Pc	3/8"	5/16" – 1"	13.5"	\$181.65

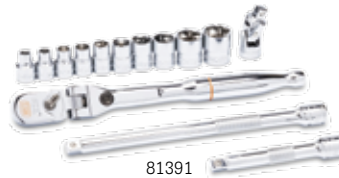

81390



81393



SAE/Metric Shallow & Deep Tool Sets

	GWR-80300	GWR-80300P	GWR-80550	GWR-80550P	GWR-80700P	GWR-80301	GWR-80551	GWR-80701
Piece Count	51-Piece	51-Piece	57-Piece	56-Piece	49-Piece	51-Piece	57-Piece	49-Piece
Drive	1/4"	1/4"	3/8"	3/8"	1/2"	1/4"	3/8"	1/2"
Points	6	6	6	6	6	12	12	12
SHALLOW Sockets	3/16" – 9/16", 4mm – 15mm	3/16" – 9/16", 4mm – 15mm	1/4" – 1", 6mm – 19mm	1/4" – 1", 6mm – 19mm	7/16" – 1-1/8", 10mm – 24mm	3/16" – 9/16", 4mm – 15mm	1/4" – 1", 6mm – 19mm	7/16" – 1-1/8", 10mm – 24mm
DEEP Sockets	3/16" – 9/16", 4mm – 15mm	3/16" – 9/16", 4mm – 15mm	1/4" – 7/8", 6mm – 19mm	1/4" – 7/8", 6mm – 19mm	1/2" – 15/16", 10mm – 19mm	3/16" – 9/16", 4mm – 15mm	1/4" – 7/8", 6mm – 19mm	1/2" – 15/16", 10mm – 19mm
Ratchet	5" long, 84-tooth	5" long, 120XP™	5" & 8" long 84-tooth	8" long, 120XP™	11" long, 120XP™	5" long, 84-tooth	5" & 8" long 84-tooth	11" long, 84-tooth
Thumbwheel Ratchet	✓	✓	✗	✗	✗	✓	✗	✗
Universal Joint	✓	✓	✓	✓	✓	✓	✓	✓
Extensions	2" & 6"	2" & 6"	3" & 6"	3" & 6"	3" & 5"	2" & 6"	3" & 6"	3" & 5"
	\$164.25	\$174.85	\$202.35	\$234.05	\$435.75	\$173.75	\$233.45	\$357.95

Chrome Sockets

GW GEARWRENCH

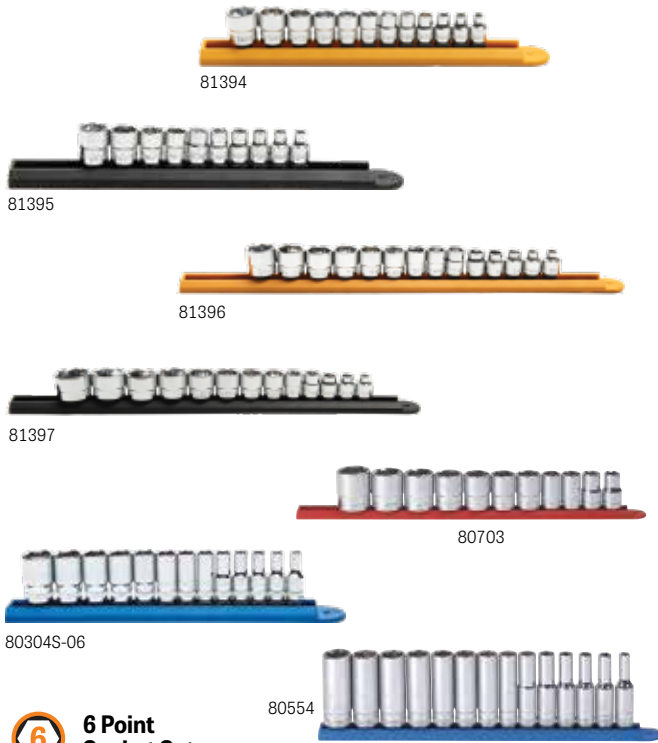

6 Point Socket Sets

Item #	Drive	Piece Count	Size Range	
STUBBY Length				
GWR-81394	1/4"	12-Piece	4mm – 15mm	\$53.65
GWR-81395	1/4"	10-Piece	3/16" – 9/16"	\$50.55
GWR-81396	3/8"	14-Piece	6mm – 19mm	\$86.85
GWR-81397	3/8"	13-Piece	1/4" – 1"	\$83.65
SHALLOW Length				
GWR-80302D	1/4"	13-Piece	4mm – 15mm	\$47.35
GWR-80303	1/4"	10-Piece	3/16" – 9/16"	\$39.45
GWR-80552	3/8"	14-Piece	6mm – 19mm	\$92.65
GWR-80553	3/8"	13-Piece	1/4" – 1"	\$72.65
GWR-80702	1/2"	13-Piece	12mm – 24mm	\$102.65
GWR-80703	1/2"	11-Piece	1/2" – 1-1/8"	\$88.45
SEMI-DEEP Length				
GWR-80304S-06	1/4"	13-Piece	4mm – 15mm	\$66.35
GWR-80305S-06	1/4"	10-Piece	3/16" – 9/16"	\$52.15
GWR-80554S-06	3/8"	14-Piece	6mm – 19mm	\$78.95
GWR-80555S-06	3/8"	11-Piece	1/4" – 7/8"	\$63.15
DEEP Length				
GWR-80304	1/4"	13-Piece	4mm – 15mm	\$71.05
GWR-80305	1/4"	10-Piece	3/16" – 9/16"	\$55.25
GWR-80554	3/8"	14-Piece	6mm – 19mm	\$86.85
GWR-80555	3/8"	11-Piece	1/4" – 7/8"	\$85.25
GWR-80704	1/2"	10-Piece	10mm – 19mm	\$123.15
GWR-80705	1/2"	8-Piece	1/2" – 15/16"	\$108.95

GW GEARWRENCH



12 Point Socket Sets

Item #	Drive	Piece Count	Size Range	
SHALLOW Length				
GWR-80306	1/4"	13-Piece	4mm – 15mm	\$50.55
GWR-80307D	1/4"	10-Piece	3/16" – 9/16"	\$37.85
GWR-80560	3/8"	14-Piece	6mm – 19mm	\$78.95
GWR-80561	3/8"	13-Piece	1/4" – 1"	\$75.85
GWR-80710D	1/2"	13-Piece	12mm – 24mm	\$102.65
GWR-80711	1/2"	11-Piece	1/2" – 1-1/8"	\$88.45
DEEP Length				
GWR-80308	1/4"	13-Piece	4mm – 15mm	\$75.85
GWR-80309D	1/4"	10-Piece	3/16" – 9/16"	\$58.45
GWR-80562	3/8"	14-Piece	6mm – 19mm	\$99.55
GWR-80563	3/8"	11-Piece	1/4" – 7/8"	\$91.65
GWR-80712	1/2"	10-Piece	10mm – 19mm	\$118.45
GWR-80713	1/2"	8-Piece	1/2" – 15/16"	\$108.95

6 Standard & Deep SAE & Metric Tool Sets

- FOUR FLAT™ sides deter rolling and are wrench compatible
- Kits include:
 - 90-tooth ratchet
 - 3" & 6" extensions
 - Universal joint (except #48-22-9010)
 - Hard case with removable inner tray



Item #	Count	Drive	Standard	Deep	
MLW-48-22-9004	50-Pc	1/4"	5/32"-9/16" 5mm-15mm	5/32"-9/16" 5mm-15mm	\$136.05
MLW-48-22-9008	56-Pc	3/8"	1/4"-1" 6mm-19mm	1/4"-7/8" 6mm-19mm	\$199.25
MLW-48-22-9010	47-Pc	1/2"	1/2"-1-1/8" 10mm-24mm	1/2"-15/16" 10mm-19mm	\$376.15

6 MLW-48-22-9487 \$397⁹⁵ 47-Pc 1/2" Drive Ratchet & Socket Set with PACKOUT™ Low-Profile Organizer

- Standard: 1/2" to 1-1/8", 10 to 24mm
- Deep: 1/2" to 15/16", 10 to 19mm
- 90-Tooth ratchet
- 3" & 5" extensions



SOCKETS, BIT SOCKETS & ACCESSORIES

Chrome Sockets

ATD-10021 **\$326⁰⁵**
21-Pc 3/4" Drive 6 Point SAE Socket Set

- (16) Shallow sockets: 7/8" - 2"
- (1) Quick release ratchet
- (2) Extensions
- (1) Breaker bar



GWR-80880 **\$778²⁵**
27-Pc 3/4" Drive 12 Point SAE Shallow Socket Set

- (16) Shallow sockets: 7/8" - 2-3/8"
- 19-3/4" Quick release ratchet
- 18" Sliding T handle
- 19" Flex handle/Breaker bar
- Extensions: 5", 8", 16"



TITAN

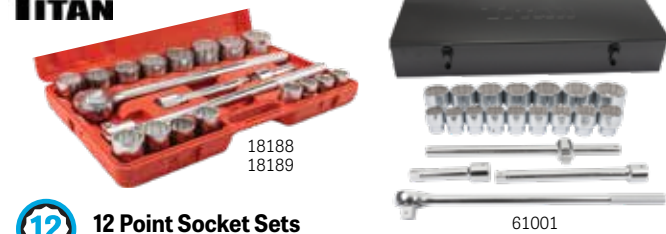

12 Point Socket Sets

Item #	Drive	Piece Count	Size Range	
TIT-18188	3/4"	21-Piece	7/8" - 2"	\$253.35
TIT-18189	3/4"	21-Piece	19mm - 50mm	\$253.35
TIT-61001	1"	20-Piece	1-5/8" - 3-1/8"	\$888.05

Extra-Deep Specialty Sockets

VIM-EDM400A **\$196⁰⁵**
1/4" Drive 4" Extra Deep 6 Point Socket Set

- 8mm - 14mm
- For removal and installation of automotive bumpers



Extra Deep 6 Pt. Sockets, 120mm Long

- Provides access to recessed areas with extra long bolts



Item #	Count	Drive	Size Range	Adapters	
CTA-1700	5-Pc	3/8"	8mm-14mm	—	\$98.25
CTA-1099	11-Pc	3/8"	8mm-18mm	3/8" x 1/4"	\$237.65
CTA-1189	17-Pc	3/8" & 1/2"	6mm-21mm	3/8" x 1/4" & 1/2" x 3/8"	\$370.35
CTA-1177	1-Pc	1/2"	19mm	—	\$28.05
CTA-1178	1-Pc	1/2"	20mm	—	\$30.55
CTA-1179	1-Pc	1/2"	21mm	—	\$30.55

Flex Head Sockets

Astro

7407



6 Point Flex Socket Sets

Item #	Drive	Piece Count	Size Range	
AST-7407	1/4"	7-Piece	3/16" - 9/16"	\$49.95
AST-7412	1/4"	12-Piece	5mm - 15mm	\$79.05

GEARWRENCH



6 Point Flex Socket Sets

Item #	Drive	Piece Count	Size Range	
GWR-80311	1/4"	12-Piece	5mm - 15mm	\$150.05
GWR-80310D	1/4"	7-Piece	3/16" - 9/16"	\$94.75
GWR-80565	3/8"	10-Piece	10mm - 19mm	\$173.75
GWR-80564	3/8"	7-Piece	3/8" - 3/4"	\$110.55

Vocational / Mechanics Tool Sets

GEARWRENCH

6 12

GWR-80942 **\$544⁷⁵**
239-Piece 1/4", 3/8", 1/2" Drive 6 & 12 Point, Metric & SAE Mechanics Tool Set with Storage Box



6

GWR-80966 **\$622⁵⁵**
243-Piece 1/4", 3/8", 1/2" Drive 6 Point, Metric & SAE Mechanics Tool Set with Storage Box



Impact Sockets

SUNEX®
T O O L S

6 Point Impact Socket Sets

Item #	Drive	Piece Count	Size Range	
SHALLOW Length				
SUN-1809	1/4"	9-Piece	5.5mm – 13mm	\$48.55
SUN-3358	3/8"	13-Piece	7mm – 19mm	\$47.95
SUN-3360	3/8"	12-Piece	5/16" – 1"	\$78.35
SUN-2652	1/2"	14-Piece	10mm – 27mm	\$83.45
SUN-2645	1/2"	26-Piece	10mm – 36mm	\$228.95
SUN-2650	1/2"	13-Piece	7/16" – 1-1/4"	\$84.65
SUN-2640	1/2"	19-Piece	3/8" – 1-1/2"	\$179.15
SUN-4684	3/4"	17-Piece	26mm – 46mm	\$470.55
SUN-4682	3/4"	11-Piece	3/4" – 1-1/2"	\$196.65
SUN-4683	3/4"	17-Piece	1" – 2"	\$602.65
SUN-4692	3/4"	26-Piece	19mm – 50mm	\$707.55
SUN-4696	3/4"	29-Piece	3/4" – 2-1/2"	\$964.45
SUN-5692	1"	21-Piece	3/4" – 2"	\$730.65
SEMI-DEEP Length				
SUN-3328	3/8"	14-Piece	8mm – 22mm	\$94.65
DEEP Length				
SUN-1812	1/4"	9-Piece	5.5mm – 13mm	\$63.35
SUN-1811	1/4"	10-Piece	3/16" – 9/16"	\$56.65
SUN-3360DD	3/8"	28-Piece Set includes: 1/2"(F) x 3/8"(M) Adapter, 3" Extension	8mm – 22mm • 5/16" – 1"	\$200.25
SUN-3359	3/8"	13-Piece	7mm – 19mm	\$69.05
SUN-3361	3/8"	12-Piece	5/16" – 1"	\$100.55
SUN-5153DD	1/2"	29-Piece Set includes Flip Sockets: 3/4" x 13/16" • 19mm x 21mm	10mm – 27mm • 7/16" – 1-1/4"	\$252.65
SUN-2653	1/2"	14-Piece	10mm – 27mm	\$136.95
SUN-2646	1/2"	26-Piece	10mm – 36mm	\$383.45
SUN-2651	1/2"	13-Piece	7/16" – 1-1/4"	\$133.55
SUN-2641	1/2"	19-Piece	3/8" – 1-1/2"	\$279.05
SUN-4638	3/4"	14-Piece	3/4" – 1-5/8"	\$330.15
SUN-4685	3/4"	17-Piece	1" – 2"	\$758.55
SUN-4693	3/4"	26-Piece	19mm – 50mm	\$816.85
SUN-4695	3/4"	29-Piece	3/4" – 2-1/2"	\$1201.45
SUN-5693	1"	21-Piece	3/4" – 2"	\$1029.25



SOCKETS, BIT SOCKETS & ACCESSORIES

Impact Sockets

SUNEX®
TOOLS



3675



3338



2820

12 Point Impact Socket Sets

Item #	Drive	Piece Count	Size Range	
SHALLOW Length				
SUN-3675	3/8"	13-Piece	7mm – 19mm	\$64.15
SUN-3674	3/8"	12-Piece	5/16" – 1"	\$70.85
SUN-2679	1/2"	13-Piece	10mm – 24mm	\$87.15
SUN-2826	1/2"	26-Piece	10mm – 36mm	\$205.25
SUN-2678A	1/2"	14-Piece	7/16" – 1-1/4"	\$113.35
SUN-2819	1/2"	19-Piece	3/8" – 1-1/2"	\$197.55
SUN-4687	3/4"	9-Piece	Thin Wall Sockets 3/4" – 1-1/4"	\$235.75
SEMI-DEEP Length				
SUN-3338	3/8"	13-Piece	7mm – 19mm	\$64.75
SUN-3337	3/8"	12-Piece	5/16" – 1"	\$68.05
DEEP Length				
SUN-3682	3/8"	13-Piece	7mm – 19mm	\$94.95
SUN-2827	1/2"	26-Piece	10mm – 36mm	\$380.85
SUN-2670	1/2"	15-Piece	3/8" – 1-1/4"	\$197.65
SUN-2820	1/2"	19-Piece	3/8" – 1-1/2"	\$318.55

Pipe Plug Sockets

SUNEX®
TOOLS

SUN-3841 **\$112⁴⁵**

11-Pc 3/8" Drive Pipe Plug Socket Set

- For use on most vehicles
- Male: 3/16" to 3/8"
- Female: 1/4" to 3/8"



3841

SUN-2841 **\$106⁷⁵**

8-Pc 1/2" Drive Pipe Plug Socket Set

- For use on most vehicles
- Male: 7/16" to 5/8"
- Female: 7/16" to 5/8"



2841

SUNEX®
TOOLS

6

SUN-1848 **\$180¹⁵**

48-Pc 1/4" Drive SAE & Metric Shallow & Deep Master Impact Socket Set

- Shallow: 3/16" to 9/16", 4mm to 15mm
- Deep: 3/16" to 9/16", 4mm to 15mm



6

SUN-3342 **\$184⁰⁵**

42-Pc 3/8" Drive SAE & Metric Shallow & Deep Master Impact Socket Set

- Shallow: 5/16" to 3/4", 8mm to 19mm
- Deep: 5/16" to 3/4", 8mm to 19mm



6

SUN-3580 **\$461⁴⁵**

80-Pc 3/8" Drive SAE & Metric Master Impact Socket Set

- Shallow: 5/16" to 3/4", 8-19mm
- Deep: 5/16" to 3/4", 8-19mm
- Universal: 3/8" to 3/4", 10mm-19mm
- Torx®: T-20 to T-55
- Female Torx®: E5 to E16
- Adapter: 1/2" (F) x 3/8" (M)
- Extensions: 3", 5", 10", 15"



6

39-Pc 1/2" Drive Shallow & Deep Master Impact Socket Sets

Item #	Shallow	Deep	
SUN-2669	9mm – 30mm	9mm – 30mm	\$330.85
SUN-2668	3/8" – 1-1/2"	3/8" – 1-1/2"	\$365.05



6

43-Pc 1/2" Drive Std. & Deep Master Impact Socket Sets

- Extensions: 3", 5", 10", 15"
- (1) Universal joint

Item #	Shallow	Deep	
SUN-2569	9mm – 30mm	9mm – 30mm	\$334.05
SUN-2568	3/8" – 1-1/2"	3/8" – 1-1/2"	\$426.15



SOCKETS, BIT SOCKETS & ACCESSORIES

Impact Sockets

GRY-9723G **\$212¹⁵**
23-Pc 1/4" Drive
Shallow SAE & Metric
MAGNETIC Impact Socket Set
 • Shallow: 3/16" – 1/2",
 5mm – 15mm
 • 2" Extension • Universal joint



GRY-9772 **\$622⁴⁵**
72-Pc 1/4" Drive
Shallow & Deep, SAE & Metric
Impact Socket Set
 • Shallow & Deep: 3/16" – 9/16"
 4mm – 15mm
 • Extensions: 2", 4", 6"
 • Universal joint • (2) Adapters



GRY-81659CRD **\$475³⁵**
59-Pc 3/8" Drive 6-Point
Shallow & Deep, SAE & Metric
Impact Socket Set
 • Stand. & Deep: 5/16" – 1", 7 – 22mm
 • 8" 72-tooth quick release ratchet
 • Extensions: 3", 6"



43-Pc 3/8" Drive Shallow & Deep, SAE
& Metric Impact Socket Set
 • Shallow & Deep: 5/16" – 3/4", 8mm – 19mm
 • 3" Extension • Universal joint • Adapter



6 GRY-1243RD **\$257⁷⁵**

12 GRY-1643RD **\$257⁷⁵**

GRY-1328RD **\$300⁶⁵**
28-Pc 1/2" Drive 6 Point
Shallow & Deep
SAE Impact Socket Set
 • Shallow & Deep: 7/16" – 1-1/4"
 • Universal Joint • Extension: 3"



GRY-1430MRD **\$290³⁵**
30-Pc 1/2" Drive 6 Point
Shallow & Deep
Metric Impact Socket Set
 • Shallow & Deep: 10mm – 24mm
 • Universal Joint • Extension: 3"



GRY-1512DM **\$337⁴⁵**
30-Pc 1/2" Drive 6 Point
Deep SAE & Metric
Impact Socket Set
 • Shallow & Deep: 7/16" – 1-1/4"
 10mm – 27mm
 • (2) Flip sockets • Extension: 3"



6 Point Impact Socket Sets

Item #	Drive	Piece Count	Size Range	
SHALLOW Length				
GRY-1213M	3/8"	13-Piece	7mm – 19mm	\$57.25
GRY-1213	3/8"	12-Piece	5/16" – 1"	\$70.45
GRY-1412M	1/2"	14-Piece	10mm – 27mm	\$94.65
GRY-1326M	1/2"	26-Piece	10mm – 36mm	\$219.45
GRY-1312	1/2"	13-Piece	7/16" – 1-1/4"	\$94.65
GRY-1319	1/2"	19-Piece	3/8" – 1-1/2"	\$176.45
GRY-8026M	3/4"	26-Piece	19mm – 50mm	\$709.45
GRY-8029	3/4"	29-Piece	3/4" – 2-1/2"	\$1174.35
SEMI-DEEP Length				
GRY-1213MSD	3/8"	13-Piece	7mm – 19mm	\$86.35
DEEP Length				
GRY-1213MD	3/8"	13-Piece	7mm – 19mm	\$84.55
GRY-1213D	3/8"	12-Piece	5/16" – 1"	\$96.45
GRY-1412MD	1/2"	14-Piece	10mm – 27mm	\$154.05
GRY-1326MD	1/2"	26-Piece	10mm – 36mm	\$402.15
GRY-1312D	1/2"	13-Piece	7/16" – 1-1/4"	\$155.45
GRY-1319D	1/2"	19-Piece	3/8" – 1-1/2"	\$314.55
GRY-8026MD	3/4"	26-Piece	19mm – 50mm	\$1048.55
GRY-8038D	3/4"	14-Piece	3/4" – 1-5/8"	\$395.05
SHALLOW + DEEP Length				
GRY-9728M	1/4"	28-Piece	4mm – 15mm Incl. 4.5mm & 5.5mm	\$137.35
GRY-9748	1/4"	48-Piece	3/16" – 9/16" 4mm – 15mm	\$238.05
GRY-1226M	3/8"	26-Piece	7mm – 19mm	\$128.15
GRY-1224RD	3/8"	24-Piece	5/16" – 1"	\$161.45



12 Point Impact Socket Sets

Item #	Drive	Piece Count	Size Range	
SHALLOW Length				
GRY-1726M	1/2"	26-Piece	10mm – 36mm	\$227.45
GRY-1719	1/2"	19-Piece	3/8" – 1-1/2"	\$182.85

ATD-6405 **\$797⁰⁵**
22-Pc 3/4" Drive 6 Point SAE
Deep Impact Socket Set
 • Deep: 7/8" – 2"
 • Budd wheel socket: 13/16" square
 • 19.5" Quick release teardrop ratchet
 • Sliding T-Bar
 • Extensions: 5", 10"



SOCKETS, BIT SOCKETS & ACCESSORIES

FREE!

While quantities last

Buy #MLW-49-66-7009, get #MLW-49-66-7002: 14-Pc 1/4" Drive Impact Socket Set, 4mm-15mm.



49-66-7009

FREE!

While quantities last

Buy #MLW-49-66-7015 or #MLW-49-66-7016, get #MLW-49-66-7007: 14-Pc 3/8" Drive Impact Socket Set, 7mm-21mm.

Milwaukee

49-66-7015
49-66-7016



Impact Sockets



84933N



84902



6 Point Impact Socket Sets

GEARWRENCH

Item #	Drive	Piece Count	Size Range	
SHALLOW Length				
GWR-84907	1/4"	14-Piece	4mm - 15mm	\$64.25
GWR-84906	1/4"	10-Piece	3/16" - 9/16"	\$61.15
GWR-84911N	3/8"	12-Piece	8mm - 19mm	\$53.55
GWR-84910N	3/8"	8-Piece	5/16" - 3/4"	\$42.85
GWR-84930N	1/2"	12-Piece	8mm - 19mm	\$64.25
GWR-84933N	1/2"	25-Piece	8mm - 36mm	\$183.65
GWR-84931N	1/2"	12-Piece	3/8" - 1-1/8"	\$73.45
GWR-84932N	1/2"	19-Piece	3/8" - 1-1/2"	\$137.75
DEEP Length				
GWR-84909	1/4"	14-Piece	4mm - 15mm	\$88.75
GWR-84908	1/4"	10-Piece	3/16" - 9/16"	\$68.85
GWR-84914N	3/8"	13-Piece	8mm - 21mm	\$75.35
GWR-84915N	3/8"	8-Piece	5/16" - 3/4"	\$62.75
GWR-84955N	1/2"	14-Piece	10mm - 27mm	\$137.75
GWR-84935N	1/2"	29-Piece	8mm - 36mm	\$331.75
GWR-84942N	1/2"	12-Piece	3/8" - 1-1/8"	\$122.45
GWR-84934N	1/2"	19-Piece	3/8" - 1-1/2"	\$256.35
GWR-84949N	1/2"	27-Piece	10mm - 27mm 7/16" - 1-1/4"	\$218.65
SHALLOW + DEEP Length Sets				
GWR-84901	1/4"	28-Piece	4mm - 15mm	\$130.05
GWR-84900	1/4"	20-Piece	3/16" - 9/16"	\$125.45
GWR-84902	1/4"	48-Piece	4mm - 15mm 3/16" - 9/16"	\$218.65



6 Point Impact Socket Sets

Item #	Drive	Piece Count	Size Range	
DEEP Length Sets				
MLW-49-66-7006	3/8"	12-Piece	5/16" - 1"	\$86.75
MLW-49-66-7014	1/2"	14-Piece	10mm - 27mm	\$113.45
MLW-49-66-7015	1/2"	29-Piece	8mm - 36mm	\$248.25
MLW-49-66-7011	1/2"	12-Piece	3/8" - 1-1/16"	\$111.15
MLW-49-66-7012	1/2"	19-Piece	3/8" - 1-1/2"	\$203.35
MLW-49-66-7016	1/2"	29-Piece	7/16" - 1-1/4" 10mm - 27mm 3" Extension	\$230.45
SHALLOW + DEEP Length Sets				
MLW-49-66-7009	3/8"	43-Piece	15/16" - 3/4" 8mm - 19mm 3" Extension Universal Joint 1/4" Hex Adapter	\$169.85



84903



84916N

GEARWRENCH



84925N



84948N
84947N

Shallow & Deep Impact Socket Sets with Accessories

	GWR-84903	GWR-84916N	GWR-84925N	GWR-84919N	GWR-84948N	GWR-84947N
Piece Count	71-Piece	44-Piece	29-Piece	25-Piece	39-Piece	39-Piece
Drive	1/4"	3/8"	3/8"	3/8"	1/2"	1/2"
Points	6	6	6	6	6	6
SHALLOW Sockets	3/16" - 9/16", 4mm - 15mm	5/16" - 3/4", 8mm - 19mm	8mm - 22mm	5/16" - 1"	9mm - 30mm	3/8" - 1-1/2"
DEEP Sockets	3/16" - 9/16", 4mm - 15mm	5/16" - 3/4", 8mm - 19mm	8mm - 22mm	5/16" - 1"	9mm - 30mm	3/8" - 1-1/2"
UNIVERSAL Sockets	1/4" - 9/16", 5mm - 15mm					
Adapter	1/4" F x 3/8" M					
Universal Joint	✓	✓	✓	✓	✓	✓
Extensions	2", 4" & 6"	3" & 6"				
	\$512.65	\$195.95	\$183.65	\$168.35	\$256.35	\$361.85



84919N

Universal Impact Sockets

SUNEX[®]
TOOLS

3654



6 Point Universal Impact Socket Sets

Item #	Drive	Piece Count	Size Range	
SHALLOW Length				
SUN-1814	1/4"	12-Piece	5mm – 15mm	\$227.35
SUN-3657	3/8"	10-Piece	10mm – 19mm	\$191.95
SUN-3654	3/8"	7-Piece	3/8" – 3/4"	\$149.95
SUN-2655	1/2"	7-Piece	13mm – 19mm	\$180.05
SUN-2657	1/2"	9-Piece	7/16" – 15/16"	\$197.55
DEEP Length				
SUN-2658	1/2"	10-Piece	10mm – 19mm	\$272.55



1210UM



9712UMD

6 Point Universal Impact Socket Sets

Item #	Drive	Piece Count	Size Range	
SHALLOW Length				
GRY-9712UM	1/4"	12-Piece	5mm – 15mm	\$238.05
GRY-1210UM	3/8"	10-Piece	10mm – 19mm	\$243.25
GRY-1212U	3/8"	12-Piece	5/16" – 1"	\$295.35
GRY-1313UM	1/2"	13-Piece	12mm – 24mm	\$372.35
GRY-1314U	1/2"	14-Piece	7/16" – 1-1/4"	\$441.85
SEMI-DEEP Length				
GRY-1210UMSD	3/8"	10-Piece	10mm – 19mm	\$253.85
DEEP Length				
GRY-9712UMD	1/4"	12-Piece	5mm – 15mm	\$283.85

84975



GTW GEARWRENCH

84924



6 Point Universal Impact Socket Sets

Item #	Drive	Piece Count	Size Range	
SHALLOW Length				
GWR-84905	1/4"	12-Piece	5mm – 15mm	\$226.15
GWR-84904	1/4"	6-Piece	1/4" – 9/16"	\$91.75
GWR-84975	3/8"	11-Piece	8mm – 19mm	\$286.45
GWR-84918N	3/8"	15-Piece	8mm – 22mm	\$218.65
GWR-84974	3/8"	7-Piece	3/8" – 3/4"	\$183.65
GWR-84917N	3/8"	8-Piece	5/16" – 3/4"	\$122.45
GWR-84979	1/2"	10-Piece	13mm – 24mm	\$316.65
GWR-84939N	1/2"	15-Piece	10mm – 24mm	\$248.75
GWR-84978	1/2"	9-Piece	1/2" – 1"	\$241.25
GWR-84938N	1/2"	13-Piece	1/2" – 1-1/4"	\$248.75
DEEP Length				
GWR-84924N	3/8"	10-Piece	10 – 19mm	\$183.65
GWR-84945N	1/2"	10-Piece	10 – 19mm	\$175.95

Special Application Sockets

1/2" Drive 12 Pt. Driveline Limited Clearance Impact Socket Sets

- Includes sockets for Chevrolet, Chrysler, Dodge, Ford, GMC and Jeep
- Remove and install driveline bolts, torque converters, cylinder heads, and 4x4 transmission casings



SUNEX[®]
TOOLS

2695

12

Item #	Count	Size Range	
SUN-2695	9-Piece	8mm – 17mm	\$295.95
SUN-2696	7-Piece	5/16" – 3/4"	\$264.35

1/2" Drive 12 Point Individual Driveline Limited Clearance Impact Sockets

Item #	Size		Item #	Size	
SUN-212ZUMDL	12mm	\$54.25	SUN-212ZUDL	3/8"	\$53.45
SUN-213ZUMDL	13mm	\$55.35	SUN-214ZUDL	7/16"	\$56.15
SUN-214ZUMDL	14mm	\$55.85	SUN-216ZUDL	1/2"	\$56.35
SUN-215ZUMDL	15mm	\$55.85	SUN-218ZUDL	9/16"	\$57.85
SUN-216ZUMDL	16mm	\$56.45	SUN-220ZUDL	5/8"	\$53.15
SUN-217ZUMDL	17mm	\$57.65	SUN-224ZUDL	3/4"	\$59.65

12



SUN-2625 \$100⁸⁵ 5-Pc 1/2" Drive 12 Point Head Bolt Impact Socket Set

- 10mm for Honda (210MZB)
- 12mm for Nissan (212MZB)
- 13mm (213MZB)
- 14mm for Toyota (214MZB)
- 1/2" (216ZB)



12



1/2" Drive 12 Point Individual Head Bolt Impact Sockets

Item #	Size	
SUN-212MZB	12mm	\$29.05
SUN-213MZB	13mm	\$38.25
SUN-216ZB	1/2"	\$40.95

SUN-2801 \$27⁷⁵ 1/2" Drive Tie Rod End Socket

- Capable of removing most bolts that have 75% of their corners stripped away



SUNEX[®]
TOOLS

TGR-10353 \$209⁹⁵ 3/4" Drive Tie Rod End Remover Socket

- For Class 6-8 trucks and equipment (Kenworth, Peterbilt, Freightliner, Mack, Volvo, etc.)
- I.D.: 3.0" / Slot width: 1.25"

TIGER TOOL



SUN-10203 \$34¹⁵ 1/2" Drive Axle Flange Nut Socket for Mercedes Benz

- Removes rear axle flange grooved nuts on Mercedes Benz models 107, 114, 115, 116, and 126 axles with CV



SUNEX[®]
TOOLS

SOCKETS, BIT SOCKETS & ACCESSORIES

Extensions



SLY-15900 **\$75²⁵** 2-Pc 1/2" Drive Extension Protectors Kit

- Male and female hammers that connect to any length 1/2" drive extension

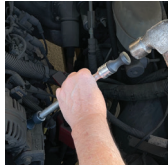

SLY-15950 **\$150⁶⁵** 5-Pc 1/2" Dr. Extension Protectors Deluxe Kit

- Male & female parts fit and protect both ends of any length socket extension
- Includes 3 interchangeable hammer heads made of nylon, aluminum & steel



4-Pc Impact Extension Sets

- 3", 5", 10", 15"



Item #	Drive	Price
SUN-3500	3/8"	\$96.05
SUN-2500	1/2"	\$121.55

Individual Impact Extensions



Item #	Drive x Length	Price	Item #	Drive x Length	Price
SUN-3503	3/8" x 3"	\$10.15	SUN-2524	1/2" x 24"	\$83.65
SUN-3505	3/8" x 5"	\$13.35	SUN-2536	1/2" x 36"	\$108.05
SUN-2505	1/2" x 5"	\$17.65	SUN-4302	3/4" x 6"	\$39.95
SUN-2510	1/2" x 10"	\$33.95	SUN-4310	3/4" x 10"	\$52.35
SUN-2515	1/2" x 15"	\$52.85	SUN-4313	3/4" x 13"	\$61.85

SUN-2536T **\$120⁰⁵** 36" Impact Extension for Transmissions

- 1/2" (F) x 3/8" (M)



SUN-3501 **\$87⁹⁵** 3-Pc Locking Impact Extension Set

- 3", 6", 12"

Impact Wobble Extension Sets

- 3", 5", 10", 15"

Item #	Drive	Price
SUN-3504	3/8"	\$63.55
SUN-2504	1/2"	\$86.65



Impact Extension Sets



2204E



Item #	Drive	Size Range	Price
GRY-9703E	1/4"	3", 6", 19"	\$39.25
GRY-1104E	3/8"	1-3/4", 3", 6", and 12"	\$83.95
GRY-2204E	1/2"	3", 5", 7", and 10"	\$108.25
GRY-3304E	3/4"	3", 7", 10", and 13"	\$206.05



GWR-84980 **\$263⁹⁵** 7-Pc 3/8" Drive 6 Point X-Core™ Pinless Universal Impact Metric Extension Socket Set

- 8, 10, 11, 12, 13, 14, 15mm
- 30° operating flex angle, 360° rotation



GWR-84926N **\$76⁴⁵** 4-Pc 3/8" Drive Impact Extension Set

- 3", 6", 10" & 15"



Extension Sets

Item #	Drive	Kit	Size Range	Price
STANDARD Extensions				
GWR-81002D	1/4"	5-Piece	2", 3", 6", 10", 14"	\$45.85
GWR-81200D	3/8"	4-Piece	1.5", 3", 6", 12"	\$38.25
GWR-81300	1/2"	3-Piece	5", 10", 15"	\$39.75
WOBBLE Extensions				
GWR-81004D	1/4"	4-Piece	2", 4", 6", 14"	\$42.85
GWR-81201	3/8"	4-Piece	3", 6", 10", 12"	\$45.85
GWR-81301	1/2"	3-Piece	5", 10", 15"	\$53.55
LOCKING Extensions				
GWR-81202	3/8"	3-Piece	3", 6", 10"	\$53.55
GWR-81302	1/2"	3-Piece	3", 5", 10"	\$84.15

TITAN



Auto-Flex Spring-Loaded Extensions

- Design prevents the joint from falling to one side

Item #	Drive x Length	Price
TIT-66109	1/4" x 6"	\$23.45
TIT-68108	3/8" x 8"	\$30.25
TIT-62110	1/2" x 10"	\$35.75

TIT-40109 **\$65²⁵** 9-Pc Impact Extension Bar Set

- 1/4" drive: 2", 4", 6"
- 3/8" drive: 1-3/4", 3", 6"
- 1/2" drive: 3", 5", 10"



TIT-42173 **\$125³⁵** 3-Pc 1/2" Drive Extra-Long Impact Extension Set

- 18", 24" and 36"

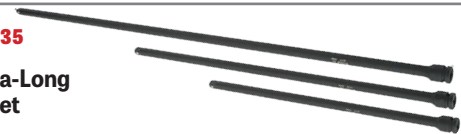

ATD-PLT99633 **\$127³⁵** 3-Pc 3/8" Drive Locking Universal Extension Set

- 4", 7", 11"



Breaker Bars/Flex Handles

TITAN

1/2" Drive Ratcheting Breaker Bars

- Head swivels 180°
- Maximum torque: 376 ft-lb

Item #	Length	
TIT-12018	18"	\$67.45
TIT-12024	24"	\$70.85



TITAN

Heavy Duty Breaker Bars

Item #	Drive	Length	Max. Torque	
TIT-12047	1/2"	30"	335 ft-lb	\$56.25
TIT-12048	3/4"	40"	1,000 ft-lb	\$131.75
TIT-12049	1"	40"	1,855 ft-lb	\$163.05



TIT-11617 **\$63³⁵**

18.5" Long 3-in-1 Breaker Bar

- Breaker bar drive size: 1/2"
- Ratchet drive sizes: 3/8" and 1/2"
- Max. torque: 3/8" drive: 175 ft-lb
1/2" drive: 405 ft-lb



Full Flex Handles / Breaker Bars

GW GEARWRENCH

Item #	Drive	Length	
GWR-81221	3/8"	12"	\$48.15
GWR-81307	1/2"	15"	\$62.75
GWR-81308D	1/2"	24"	\$68.85



Socket Adapters/Universal Joint Adapters

VIM

VIM-WSA100 **\$66³⁵** 3-Pc Wobble Socket Adapter Set for Box Wrenches

- Convert any box wrench to a wobble square drive
- Includes: 1/4" x 10mm, 3/8" x 14mm, 1/2" x 19mm
- 2-step wobble drive can swivel up to 15° or lock in fixed position by pushing socket further in



TITAN

TIT-40000 **\$101⁹⁵** 8-Pc Impact Socket Adapter Set

- 1" (F) x 3/4" (M)
- 3/4" (F) x 1/2" (M)
- 1/2" (F) x 3/8" (M)
- 3/8" (F) x 1/4" (M)
- 1/4" (F) x 3/8" (M)
- 3/8" (F) x 1/2" (M)
- 1/2" (F) x 3/4" (M)
- 3/4" (F) x 1" (M)



TIT-30936 **\$16⁸⁵**

3-Pc Low Profile Impact Adapter Set

- 1/2" (F) to 3/4" (M)
- 1/4" (F) to 3/8" (M)
- 3/8" (F) to 1/2" (M)



Impact Adapters

Item #	Size/Description	
TIT-42356	1/2" (F) x 3/4" (M) Increasing Adapter	\$9.65
TIT-42358	3/4" (F) x 1" (M) Increasing Adapter	\$23.25
TIT-42357	3/4" (F) x 1/2" (M) Reducing Adapter	\$18.35
TIT-42359	1" (F) x 3/4" (M) Reducing Adapter	\$33.85



TIT-16150 **\$83²⁵**

5-Pc Pin-Free Locking Impact Universal Joint Adapter Set

- 1/4" to 3/8" drive
- 3/8" to 1/2" drive
- 3/8" to 1/4" drive
- 1/2" to 3/8" drive
- 1/2" to 3/4" drive



Impact Adapters

Item #	Size	
SUN-3303	3/8" (F) x 1/4" (M)	\$12.55
SUN-2303	1/2" (F) x 3/8" (M)	\$22.75
SUN-4305	3/4" (F) x 1/2" (M)	\$44.65
SUN-5305	1" (F) x 3/4" (M)	\$67.85

SUNEX[®]
TOOLS



GWR-81205 **\$191²⁵**

10-Pc 1/4", 3/8", and 1/2" Drive Universal Adapter Set

- Universal joints: 1/4", 3/8" drive
- Impact univ. joints: 1/4", 3/8", 1/2" drive
- Adapters: 1/4" F x 3/8" M; 3/8" F x 1/4" M; 3/8" F x 1/2" M; 1/2" F x 3/8" M; 1/2" F x 3/4" M

GW GEARWRENCH



CRESCENT

eSHOK-GUARD™ - 1000V Socket Isolator

- Withstands impact applications

Item #	Drive	
CRE-CAEAD316	1/4"	\$18.95
CRE-CAEAD324	3/8"	\$20.45
CRE-CAEAD332	1/2"	\$21.95



SOCKETS, BIT SOCKETS & ACCESSORIES

Socket Adapters/Universal Joint Adapters



MUK-800 610 **\$51⁵⁵**

2-Pc Uni-Adapter Kit

- Changeable adapters with 4 different sizes
- 1/4" to 3/8" and 3/8" to 1/4"
- 3/8" to 1/2" and 1/2" to 3/8"



TIT-16151 **\$59⁴⁵**

3-Pc Pin-Free Locking Impact Universal Joint Set

- 1/4", 3/8", 1/2" drive



TIT-40160 **\$46⁸⁵**

3-Pc Impact Universal Joint Set

- 1/4", 3/8", 1/2" drive



TIT-17407 **\$19⁵⁵**

7-Pc Adapter and Universal Joint Set

Adaptor sizes:

- 1/4" (F) to 3/8" (M) • 3/8" (F) to 1/4" (M)
- 3/8" (F) to 1/2" (M) • 1/2" (F) to 3/8" (M)

U-Joint sizes: 1/4", 3/8", 1/2"



Impact Universal Joints

Item #	Drive	
SUN-1800	1/4"	\$18.65
SUN-3301	3/8"	\$23.95
SUN-2300	1/2"	\$33.45
SUN-4304	3/4"	\$81.25



MUK-810 203 **\$119⁵⁵**

3-Pc Pinless Impact Adapter Kit

- 1/4", 3/8" and 1/2" drive
- Adapters work as both a universal joint and straight connector

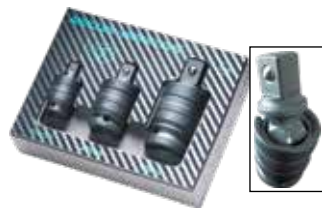

GWR-84960 **\$76⁴⁵**

3-Pc X-CORE™ Pinless Impact Universal Joint Set

- 1/4", 3/8" & 1/2" drive



VIM-FFA100 **\$80⁰⁵**

3-Pc Firm Flex Dual Drive Universal Joint Adapter Set

- 1/4" square drive x 11mm
- 3/8" square drive x 17mm
- 1/2" square drive x 21mm



VIM-FFDD400K **\$145⁵⁵**

4 Piece Firm Flex Dual Drive Universal Joint Kit

- Includes E10 and 10mm sockets, 1/4" bit holder, 1/4" drive adapter
- 1/4" x 11mm dual drive socket base works with either a 1/4" drive ratchet or an 11mm wrench



VIM-PL100 **\$78⁹⁵**

1/4" Hex Power-Lock Square Drive Adapter Set

- 1/4", 3/8" and 1/2" square drives



Impact Locking Socket Adapters

- Insert into socket, socket locks into place, pull back to release



Item #	Length	Drive	
TIT-15211	3"	1/4"	\$10.75
TIT-15212	3"	3/8"	\$11.35
TIT-15213	3"	1/2"	\$12.15
TIT-15210	3"	3-Pc Set: 1/4", 3/8", 1/2"	\$30.55
TIT-15215	6"	1/4"	\$13.55
TIT-15216	6"	3/8"	\$14.55
TIT-15217	6"	1/2"	\$15.75
TIT-15214	6"	3-Pc Set: 1/4", 3/8", 1/2"	\$42.85



Impact Socket Adapters

Item #	Piece Count	Overall Length	Drive	
TIT-12082	3-Piece	2-1/2"	1/4", 3/8", 1/2"	\$6.45
TIT-12086	3-Piece	6"	1/4", 3/8", 1/2"	\$14.45
TIT-15206	3-Piece	12"	1/4", 3/8", 1/2"	\$26.45
TIT-12087	6-Piece	2-1/2" & 6"	1/4", 3/8", 1/2"	\$22.25
TIT-12089	9-Piece	2-1/2", 6" & 12"	1/4", 3/8", 1/2"	\$43.45

TIT-12001 **\$11⁵⁵**

6-Pc Stubby and Wobble Impact Grade Socket Adapter Set

- (3) Stubby: 1/4", 3/8", 1/2" drive (1.7" long)
- (3) Wobble: 1/4", 3/8" drive (2.5" long) and 1/2" drive (2.8" long)



Female Torx® & Female Torx Plus® Bit Sockets



CTA-1469 **\$68⁵⁵**

11-Pc Flat-Cut External Torx® Socket Set for Low Profile Fasteners

- 3/8" drive
- E5 to E20



LIS-26280 **\$67²⁵**

10-Pc External Torx® Socket Set

- E5 to E20
- 1/4", 3/8", 1/2" drive



VIM-UJET400 **\$134³⁵**

9-Pc 1/4" Sq. Drive Universal Joint Female Torx® Socket Set

- E4 – E16

CTA-9220 **\$216⁹⁵**



13-Pc Universal Joint Female Torx® Socket Set

- 1/4", 3/8", 1/2" drives
- E4 – E24



GWR-80583 **\$78⁹⁵**

13-Pc 1/4", 3/8" and 1/2" Drive External Torx® Socket Set

- E4 – E24



External Torx® Deep Socket Sets

Item #	Kit	Drive	Size	
TIT-66320	7-Piece	1/4"	E4 – E11	\$17.65
TIT-68302	8-Piece	3/8", 1/2"	E11 – E24	\$35.65

ATD-13779 **\$126⁴⁵**



28-Pc Female Torx® Socket Set

- Shallow: E4 – E24
- Deep: E4 – E24



CTA-1220 **\$191³⁵**

16-Pc 5 Lobe EPR Torx Plus® Socket Set

- 6EPR to 32EPR
- 1/4", 3/8", 1/2" drive



VIM-TMS-VSEP **\$170⁸⁵**

13-Pc 1/4", 3/8" and 1/2" Drive External Torx Plus® Socket Set

- EP4-EP24, on a 10" magnetic rail
- Approved for hand and power tools



LIS-83100 **\$54⁵⁵**

9-Pc External Torx Plus® Socket Set

- EP6 to EP18
- 1/4", 3/8", 1/2" drive



5420

9666

External Torx Plus® Impact Sockets

- Services elliptical-shaped fasteners

Item #	Kit	Drive	Size	
CTA-5420	15-Piece	1/4", 3/8", 1/2"	EP6 – EP32	\$165.85
CTA-9666	3-Piece	1/2"	EP20, EP22, EP24	\$33.65



TIT-17414 **\$21⁸⁵**

3-Pc 1/2" Drive External Torx Plus® Impact Socket Set

- EP20 for Nissan Altima & Rogue head bolts
- EP22 for Honda Civic motor mounts
- EP24 for Ford Super-Duty bedliner bolts



TIT-17418 **\$37⁶⁵**

8-Pc External Torx Plus® Impact Socket Set

- 1/4", 3/8", 1/2" drive
- EP6 – EP18

SOCKETS, BIT SOCKETS & ACCESSORIES

Torx® & Torx® Plus Bit Sockets

GEARWRENCH



Torx® Bit Socket Sets

Item #	Style	Drive	Pieces	Size Range	
GWR-80722		1/4", 3/8"	10-Piece	T10 – T55	\$56.85
GWR-80723		1/4", 3/8", 1/2"	13-Piece	T8 – T60	\$78.95
GWR-80725		1/4", 3/8", 1/2"	13-Piece	T7 – T60	\$94.75



ATD-125 **\$97⁴⁵** **35-Pc Torx® Bit Socket Set** (13) Torx®:

- 1/4" drive: T8 - T30
- 3/8" drive: T40 - T55
- 1/2" drive: T60

(12) Tamperproof Torx®:

- 1/4" drive: TT7 - TT30
- 3/8" drive: TT40 - TT55

(10) Female Torx®:

- 1/4" drive: E4 - TE8
- 3/8" drive: E10 - E16
- 1/2" drive: E18



ATD



ATD-13773 **\$46⁰⁵** **13-Pc Torx® Bit Socket Set**

- T8 - T60
- 1/4", 3/8", 1/2" drives



ATD



ATD-13775 **\$47⁸⁵** **13-Pc Tamperproof Torx® Bit Socket Set**

- TT8 - TT60
- 1/4", 3/8", 1/2" drives



ATD



ATD-13776 **\$38¹⁵** **7-Pc 4.5" Long Tamperproof Torx® Bit Socket Set**

- 3/8" Drive: TT10 - TT40



ATD

VIM

S2



VIM-V458L **\$201⁶⁵** **18-Pc Long Torx® Master Bit Socket Set**

- 1/4" and 3/8" square drive black bits with chrome holders
- (9) 4.5" long: T10 - T50
- (9) 8" long: T10 - T50



OTC



OTC-6100 **\$61⁹⁵** **12-Pc Standard Torx® Socket Set**

- T10 - T60
- 1/4", 3/8", 1/2" drives



TITAN



TIT-16143 **\$48⁰⁵** **10-Pc Stubby Tamper Resistant Torx® Impact Bit Socket Set**

- 1/4" drive: TR10, TR15, TR20, TR25, TR27, & TR30
- 3/8" drive: TR40, TR45, TR47, & TR50



VIM

S2



VIM-IMPACT-HCT6 **\$118⁴⁵** **10-Pc Stubby Half Cut Torx® Impact Driver Set**

- T20 - T60



VIM

S2



VIM-HCT1050A **\$75⁴⁵** **10-Pc 1/4" Drive Torx® & Torx Plus® Half Cut Stubby Driver Set**

- T10 - T50
- 6" green Magrail™



Torx® & Torx® Plus Bit Sockets



VIM-IMPTX800 **\$108⁹⁵** 4-Pc 1/2" Drive Large Impact Torx® Driver Set

- Torx®: T70, T80, T90
- Tamperproof Torx®: TR100



VIM-TMS77 **\$527⁶⁵**

77-Pc Master Torx® Bit Socket Set

- Rated for manual & impact use
- Torx®: T6 – T70
- Tamperproof Torx®: TR8 – TR60
- Female Torx®: E4 – E24
- Torx® Plus (6 lobe): IP8 – IP60
- Torx® Plus (5 lobe): IPR8 – IPR60
- Female Torx® Plus (6 lobe): EP4 – EP24



ASM-6500T-100 **\$102⁹⁵** 3/4" Drive 2.3" Long Torx® Socket

- T-100
- Used to remove a bracket on MAN commercial buses and trucks to be able to perform brake work



OTC-5900A-PLUS **\$188⁴⁵**

53-Pc Master Torx® Bit Socket Set

- 1/4", 3/8", 1/2" drive
- Torx®: T6 – T70
- Tamper-resistant Torx®: TT8 – TT60
- Female Torx®: E4 – E24
- Torx Plus® (6 lobes): TP8 – TP60
- Female Torx Plus® (6 lobes): EP24 (required for Ford Super Duty pick-up beds starting model year 2017)



VIM-TMS34PF **\$210⁵⁵** 34-Pc Master Torx® Bit Socket Set

- Rated for manual & impact use
- Torx®: T8 – T60
- Tamperproof Torx®: TR10 – TR55
- Female Torx®: E4 – E20



ATD-13778 **\$51⁹⁵** 12-Pc 5 Lobe Tamperproof Torx Plus® Bit Socket Set

- 8IPR – 60IPR



OTC-6180 **\$61⁹⁵** 9-Pc Torx Plus® Socket Set

- TP10 – TP50
- 1/4" and 3/8" drives



CTA-2752 **\$93¹⁵**

5-Pc 1/2" Drive 5-Point Socket Set

- Male socket: 10mm
- Female sockets: 10, 12, 14 & 19mm



ATD-13777 **\$48⁶⁵** 12-Pc 6 Lobe Torx Plus® Bit Socket Set

- TP8 – TP60



VIM-TORXTBS **\$69⁹⁵** 8-Pc Truck Bed Bolt Remover Set

- Rated for manual & impact use
- 3/8" drive Torx®: T40, T45, T50, T55
- 3/8" drive Torx® Plus: IP45, IP50, IP55
- 1/2" drive Female Torx Plus®: EP24



ATD-13780 **\$73⁷⁵** 13-Pc 6 Lobe Ribe®/Polydrive Bit Socket Set

- M4 – M16
- 1/4", 3/8", 1/2" drives



Pentagonal Bit Sockets

Ribe®/Polydrive Bit Sockets

SOCKETS, BIT SOCKETS & ACCESSORIES

Hexagonal Bit Sockets

SUNEX
TOOLS



Hex Bit Impact Socket Sets

Item #	Drive	Piece Count	Size Range	
STUBBY Length				
SUN-3646	3/8"	16-Piece	6mm - 19mm 1/4" - 3/4"	\$84.05
SHALLOW Length				
SUN-2639	1/2"	10-Piece	6mm - 19mm	\$128.25
SUN-2638	1/2"	10-Piece	1/4" - 3/4"	\$128.15
SUN-4507	3/4"	5-Piece	14mm - 24mm	\$168.05
SUN-4506	3/4"	5-Piece	3/4" - 1-1/4"	\$168.05
SUN-5607	1"	6-Piece	14mm - 27mm	\$288.35
SUN-5606	1"	6-Piece	3/4" - 1-3/8"	\$295.15
EXTENDED Length				
SUN-2639L	1/2"	10-Piece	6mm - 19mm	\$174.15
SUN-2638L	1/2"	10-Piece	1/4" - 3/4"	\$174.15
SUN-2637L	1/2"	20-Piece	6mm - 19mm 1/4" - 3/4"	\$312.55

SUNEX
TOOLS

SUN-9921 **\$123⁸⁵** 14-Pc 3/8" Drive Long Ball Hex & Hex Bit Socket Set

• 3mm - 10mm

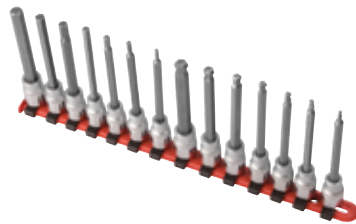

1498MH

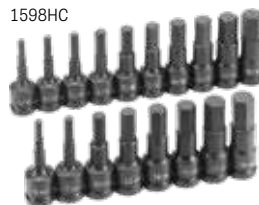

1598HC

Standard Length Hex Bit Impact Socket Sets

Item #	Drive	Piece Count	Size Range	
GRY-1298HC	3/8"	13-Piece	4mm - 12mm 3/16" - 1/2"	\$212.35
GRY-1498MH	1/2"	10-Piece	6mm - 19mm	\$148.75
GRY-1398H	1/2"	10-Piece	1/4" - 3/4"	\$148.75
GRY-1598HC	1/2"	18-Piece	6mm - 18mm 1/4" - 3/4" (19mm)	\$275.05

SUNEX
TOOLS

Individual Hex Bit Impact Sockets



Item #	Size		Item #	Size	
3/8" Drive					
SUN-36481	4mm	\$10.45	SUN-36471	3/16"	\$10.45
SUN-36482	5mm	\$10.45	SUN-36472	7/32"	\$10.45
SUN-36483	6mm	\$10.45	SUN-36473	1/4"	\$10.45
SUN-36484	7mm	\$10.45	SUN-36474	5/16"	\$10.45
SUN-36485	8mm	\$10.45	SUN-36475	3/8"	\$10.45
SUN-36486	9mm	\$10.45	SUN-36476	7/16"	\$10.45
SUN-36487	10mm	\$10.45	SUN-36477	1/2"	\$10.45
SUN-36488	12mm	\$10.45	SUN-36479	5/8"	\$10.25
SUN-36489	14mm	\$10.25			
1/2" Drive					
SUN-26491	6mm	\$14.55	SUN-26481	1/4"	\$14.65
SUN-26492	7mm	\$14.55	SUN-264811	9/32"	\$12.75
SUN-26493	8mm	\$14.55	SUN-26482	5/16"	\$14.55
SUN-26495	10mm	\$14.65	SUN-26483	3/8"	\$14.65
SUN-264914	11mm	\$13.75	SUN-26484	7/16"	\$14.65
SUN-26496	12mm	\$14.55	SUN-26485	1/2"	\$14.65
SUN-26497	14mm	\$14.65	SUN-26486	9/16"	\$14.65
SUN-264912	15mm	\$14.65	SUN-26487	5/8"	\$14.65
SUN-26499	17mm	\$14.65	SUN-26488	11/16"	\$14.55
SUN-264913	18mm	\$14.55	SUN-26489	3/4"	\$14.55
SUN-264910	19mm	\$12.95			
3/4" Drive					
SUN-450714	14mm	\$34.85	SUN-45061	3/4"	\$38.25
SUN-450717	17mm	\$34.85	SUN-45062	7/8"	\$38.25
SUN-450719	19mm	\$34.85	SUN-45063	1"	\$38.25
SUN-450722	22mm	\$34.85	SUN-45064	1-1/8"	\$38.25
SUN-450724	24mm	\$34.85	SUN-45065	1-1/4"	\$38.25

TITAN

1/2" Drive Large Hex Bit Sets

• Magnetic rack sticks to ferrous metal surfaces

Item #	Size Range	
TIT-16131	13mm - 22mm	\$87.35
TIT-16130	9/16" - 7/8"	\$83.05



Hexagonal Bit Sockets

GEARWRENCH



Hex Bit Socket Sets

Item #	Drive	Piece Count	Size Range	
GWR-80580	3/8"	12-Piece	2mm – 12mm	\$115.35
GWR-80578	3/8" & 1/2"	10-Piece	4mm – 17mm	\$110.55
GWR-80581	3/8"	12-Piece	1/16" – 3/8"	\$102.65
GWR-80720	1/2"	7-Piece	6mm – 19mm	\$94.75
GWR-80721	1/2"	7-Piece	5/16" – 3/4"	\$83.65

VIM



VIM-HMS26 **\$194⁵⁵**

26-Pc Master Hex Bit Socket Set

- (13) Metric: 2.5mm – 19mm
- (13) SAE: 1/8" – 3/4"

VIM



IMPACT-VI6

10-Pc 3/8" Sq. Drive Hex Driver Sets

- Dark gun metal gray plating

Item #	Size Range	
VIM-IMPACT-VM6	6mm – 18mm	\$114.25
VIM-IMPACT-VI6	3/16" – 3/4"	\$101.85

VIM



VIM-SHM400A **\$71⁷⁵**

10-Pc 1/4" Drive Metric Stubby Hex Bit Socket Set

- 2mm – 10mm

ATD



Hex Bit Socket Sets

Item #	Drive	Piece Count	Size Range	
ATD-13785	1/4", 3/8", 1/2"	13-Piece	2mm – 14mm	\$46.55
ATD-13784	1/4", 3/8", 1/2"	13-Piece	5/64" – 1/2"	\$43.45
ATD-13787	3/8"	7-Piece	4.5" Extra Long 3mm – 10mm	\$39.05
ATD-13786	3/8"	7-Piece	4.5" Extra Long 1/8" – 3/8"	\$41.85
ATD-13794	1/4", 3/8", 1/2"	13-Piece	5/64" – 9/16"	\$49.15

Triple Square/XZN Bit Sockets

VIM

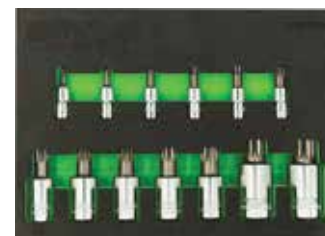

VIM-XZNS1000A **\$138⁷⁵**

13-Pc XZN Bit Socket Set

- 2-pc driver with a stubby bit over a standard socket
- 1/4" drive: XZN 4 – 9
- 3/8" drive: XZN 10 – 13, and XZN Tamperproof 14
- 1/2" drive: XZN Tamperproof 16 H & 18H

VIM



VIM-XZN100A **\$117⁶⁵**

13-Pc 3/8" Drive XZN Stubby Bit Socket Set

- XZN 4 – 14
- XZN Tamperproof 16H and 18H

VIM



VIM-IMPACT-XZN6 **\$119⁶⁵**

10-Pc 3/8" & 1/2" Sq. Drive XZN Impact Bit Socket Set

- XZN 4 – 18

VIM



VIM-XZN400 **\$126⁹⁵**

9-Pc 4" Long XZN Bit Socket Set

- XZN 4 – 18
- 1/4", 3/8", 1/2" square drives

SUNEX
TOOLS



SUN-3640 **\$94⁰⁵**

8-Pc 3/8" Drive Stubby Triple Square Impact Bit Socket Set

- M4 – M16
- One piece design for maximum durability

TITAN



TIT-16138 **\$40⁴⁵**

9-Pc Stubby Triple Square Impact Bit Socket

- (4) 1/4" drive, sizes: MT4, MT5, MT6 and M8
- (3) 1/2" drive, sizes: MT14, MT16 and MT18
- (2) 3/8" drive, sizes: MT10 and M12

SOCKETS, BIT SOCKETS & ACCESSORIES

Triple Square/XZN Bit Sockets



10-Pc Triple Square XZN Bit Socket Set

- XZN: M4 – M12
- Tamperproof XZN: M14 – M18
- 1/4", 3/8", 1/2" drives

Item #	Length	
ATD-13782	Standard	\$56.65
ATD-13781	4" Extra Long	\$77.05



MorTorq® Bit Sockets



CTA-8140 **\$63⁷⁵**

5-Pc MorTorq® Super Socket Set

- Sizes: M0, M1, M2, M3, M4, all 3/8" square drive
- Services new fasteners found on many GM, Chrysler, BMW, Nissan, Honda & Fiat



VIM-MTS02 **\$19⁶⁵**

3/8" Drive MorTorq® Super Driver Bit Socket

- Size: 2



Combination Bit Socket Sets



GWR-80742 **\$264⁵⁵**

84-Pc Master SAE/Metric Hex & Torx® Bit Socket Set 1/4" Drive:

- Hex bits: 1/8" to 1/4", 2.5mm to 6mm
- Torx® bits: T8 to T27 • Tamper proof Torx®: T8 to T30
- Torx® long: T8 to T30 • E-Torx®: E4 to E8

3/8" Drive:

- Hex bits: 7/32" to 3/8", 6mm to 10mm
- Long ball Hex: 4mm to 10mm
- Torx® bits: T30 to T55 • Tamper proof Torx®: T40 to T55
- Torx® long: T40 to T50 • E-Torx®: E10 to E16

1/2" Drive:

- Hex bits: 7/16" to 3/4", 10mm to 19mm
- Torx® bits: T60 • Tamper proof Torx®: T60 • E-Torx®: E18 to E24



VIM-MMS450 **\$257⁸⁵**

50-Pc 1/4" Drive Stubby Bit Socket Set

- For hand and power tools
- (10) Hex SAE: 5/64" – 3/8"
- (10) Hex metric: 2mm – 10mm
- (2) Phillips: #1, #2
- (2) Slotted: 1/4" & 3/8"
- (8) XZN: XZN4 – XZN12
- (8) Torx® Plus: IP15 – IP50
- (10) Torx®: T8 – T50



VIM-MMS64 **\$422²⁵**

64-Pc 1/4", 3/8", 1/2" Drive Stubby Bit Socket Set

- For hand and power tools
- Torx®: T10 – T70
- Tamperproof Torx®: TR10 – TR55
- Female Torx®: E4 – E20
- Hex SAE: 1/8" – 3/4"
- Hex metric: 2.5mm – 22mm



SUN-3569 **\$373¹⁵**

84-Pc 3/8" Drive Master Impact Bit Socket Set

- Long Hex drivers: 4 – 12mm, 3/16" – 1/2"
- Hex drivers: 6 – 9mm, 1/4" – 3/4"
- Hex sockets: 4 – 14mm, 3/16" – 5/8"
- Torx® sockets: T20 – T55
- Female Torx® sockets: E5 – E16
- Tamperproof Torx®: T10H – T50H
- Triple square: M4 – M16



VIM-SFP10 **\$72³⁵**

10-Pc Stubby Slotted & Phillips Bit Socket Set

- (4) Phillips: #1, #2, #3, #4
- (6) Slotted: 3.5mm – 12mm



Combination Non Ratcheting Wrenches

STANDARD
9714A



V-GROOVE
9917MA



STUBBY
9930M



JUMBO
97010A

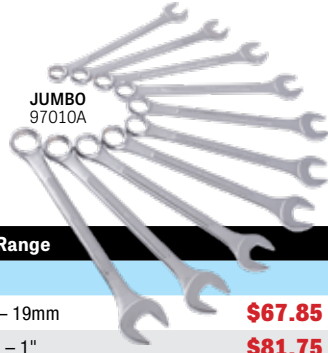

SUNEX TOOLS Combination Wrench Sets

Item #	Piece Count	Size Range	
STUBBY Sizes			
SUN-9930M	10-Piece	10mm – 19mm	\$67.85
SUN-9930	11-Piece	3/8" – 1"	\$81.75
STANDARD Sizes			
SUN-9715A	14-Piece	6mm – 19mm	\$85.55
SUN-9917MA	12-Piece	8mm – 19mm with V-GROOVE	\$82.45
SUN-9605MA	5-Piece	20mm – 24mm	\$56.45
SUN-9606MA	6-Piece	25mm – 32mm	\$115.55
SUN-9714A	14-Piece	3/8" – 1-1/4"	\$107.15
SUN-9915A	14-Piece	3/8" – 1-1/4" with V-GROOVE	\$146.25
JUMBO Sizes			
SUN-9707MA	7-Piece	33mm – 50mm	\$228.35
SUN-9707A	7-Piece	1-5/16" – 2"	\$239.25
SUN-97010A	10-Piece	1-5/16" – 2"	\$349.75
SUN-9604	4-Piece	2-1/8" - 2-1/2"	\$477.65

Individual Jumbo Combination Wrenches



Item #	Size	Price	Item #	Size	Price
SUN-933A	33mm	\$31.35	SUN-952A	1-5/8"	\$55.65
SUN-934A	34mm	\$34.95	SUN-954A	1-11/16"	\$51.65
SUN-936A	36mm	\$38.65	SUN-956A	1-3/4"	\$58.95
SUN-938A	38mm	\$44.35	SUN-960A	1-7/8"	\$77.85
SUN-941A	41mm	\$47.95	SUN-962A	1-13/16"	\$81.95
SUN-946A	46mm	\$66.25	SUN-964A	2"	\$92.75
SUN-950A	50mm	\$77.35	SUN-968	2-1/8"	\$121.75
SUN-942A	1-5/16"	\$35.15	SUN-972	2-1/4"	\$132.55
SUN-944A	1-3/8"	\$36.95	SUN-976	2-3/8"	\$139.75
SUN-945A	1-7/16"	\$40.55	SUN-980	2-1/2"	\$157.65
SUN-948A	1-1/2"	\$48.15			

GWR-81925 **\$119⁵⁵** 14-Pc 6 Point Metric Combination Wrench Set

- 6mm to 19mm
- 15" offset box end
- Comes in a roll pouch



TITAN

17330

12 Point Combination Wrench Sets



Item #	Piece Count	Size Range	
STANDARD Sizes			
TIT-17330	16-Piece	10mm – 32mm	\$82.45
TIT-17329	14-Piece	3/8" – 1-1/4"	\$80.25
JUMBO Sizes			
TIT-17292	10-Piece	30mm – 42mm	\$206.85
TIT-17289	7-Piece	34mm – 50mm	\$211.05
TIT-17288	10-Piece	1-5/16" – 2"	\$291.35
TIT-17290	6-Piece	1-3/8" – 2"	\$206.85
TIT-17291	4-Piece	2-1/8" – 2-1/2"	\$299.75



12 Raised Panel Combination Wrench Sets



Item #	Piece Count	Size Range	
STANDARD Size			
TBQ-5116M	16-Piece	10mm – 32mm	In a Roll Pouch \$72.05
TBQ-6014	14-Piece	3/8" – 1-1/4"	In a Roll Pouch \$70.95
JUMBO Size			
TBQ-5110MJ	10-Piece	30mm – 42mm	\$141.65
TBQ-6010J	10-Piece	1-5/16" – 2"	\$200.65
TBQ-6004J	4-Piece	2-1/8" – 2-1/2"	\$206.65



Long Pattern Combination Wrench Sets

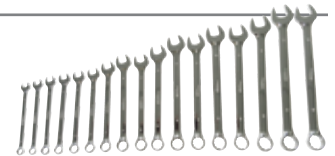

Item #	Piece Count	Size Range	
ATD-PLT99570	17-Piece	8mm – 24mm	\$198.15
ATD-PLT99550	17-Piece	1/4" – 1-1/4"	\$233.65

GEARWRENCH

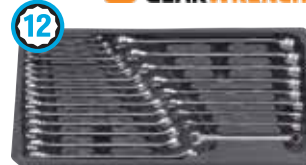

GWR-81900 **\$376⁹⁵**
24-Pc 12 Point SAE/Metric Long Pattern Combination Wrench Set
• 1/2" to 1"
• 8mm to 22mm

GEARWRENCH



GWR-81903 **\$216⁵⁵**
20-Pc 12 Point SAE/Metric Stubby Combination Wrench Set
• 3/8" to 15/16"
• 10mm to 19mm
• Offset box end for increased access

Combination Non Ratcheting Wrenches

12

Long Pattern
Combination
Wrench Sets

Item #	Pieces	Range	Price
GWR-81901	15-Piece	1/4" - 1"	\$271.35
GWR-81902	15-Piece	8mm - 22mm	\$243.15
GWR-81920	18-Piece	7mm - 24mm	\$217.65
GWR-81916	22-Piece	6mm - 32mm	\$286.95
GWR-81917	18-Piece	1/4" - 1-1/4"	\$286.45

GW GEARWRENCH

81902



81920



Combination Ratcheting Wrenches



9550

GW



9570

12

Stubby Flex-Head Combination
Ratcheting Wrench Sets



Item #	Piece Count	Size Range	Price
GWR-9550	10-Piece	10mm - 19mm	\$301.55
GWR-9570	7-Piece	3/8" - 3/4"	\$195.95



9520D

GW



9507D

12

Stubby Combination
Ratcheting Wrench Sets



Item #	Piece Count	Size Range	Price
GWR-9520D	10-Piece	10mm - 19mm	\$215.85
GWR-9507D	7-Piece	3/8" - 3/4"	\$135.15

GW

Combination Ratcheting Wrenches

• 9000/9100 Series are 72-Tooth. 86000 Series are 90-Tooth.



Item #	Size	Price	Item #	Size	Price
GWR-86906	6mm	\$24.85	GWR-86940	1/4"	\$24.85
GWR-86907	7mm	\$26.35	GWR-86941	5/16"	\$26.35
GWR-86908	8mm	\$27.85	GWR-86942	11/32"	\$27.85
GWR-86909	9mm	\$26.05	GWR-86943	3/8"	\$26.25
GWR-86910	10mm	\$27.15	GWR-86944	7/16"	\$27.25
GWR-86911	11mm	\$28.05	GWR-86945	1/2"	\$28.85
GWR-86912	12mm	\$29.15	GWR-86946	9/16"	\$33.65
GWR-86913	13mm	\$30.35	GWR-86947	5/8"	\$35.15
GWR-86914	14mm	\$32.05	GWR-86948	11/16"	\$38.05
GWR-86915	15mm	\$33.55	GWR-86949	3/4"	\$40.95
GWR-86916	16mm	\$34.95	GWR-86950	13/16"	\$49.75
GWR-86917	17mm	\$36.55	GWR-86951	7/8"	\$51.25
GWR-86918	18mm	\$38.25	GWR-86952	15/16"	\$60.05
GWR-86919	19mm	\$39.45	GWR-86953	1"	\$61.45
GWR-86920	20mm	\$49.75	GWR-86954	1-1/16"	\$65.85
GWR-86921	21mm	\$51.25	GWR-86955	1-1/8"	\$76.15
GWR-86922	22mm	\$52.75	GWR-86956	1-1/4"	\$86.35
GWR-86924	24mm	\$60.05	GWR-9060D	1-5/16"	\$86.35
GWR-86925	25mm	\$61.45	GWR-9062D	1-3/8"	\$87.85
GWR-9127D	27mm	\$65.85	GWR-9040	1-7/16"	\$109.85
GWR-9130D	30mm	\$73.15	GWR-9042	1-1/2"	\$111.25
GWR-9132	32mm	\$80.55	GWR-9044	1-9/16"	\$128.85
GWR-9134D	34mm	\$87.85	GWR-9046D	1-5/8"	\$130.35
GWR-9141D	41mm	\$125.95	GWR-9048	1-11/16"	\$153.75
GWR-9146D	46mm	\$183.05	GWR-9050D	1-3/4"	\$155.15
GWR-9150	50mm	\$222.55	GWR-9052D	1-13/16"	\$183.05
			GWR-9054D	1-7/8"	\$184.45
			GWR-9056D	2"	\$219.65

GW

90-Tooth Reversible Combination Ratcheting Wrenches



Item #	Size	Price
GWR-86608	8mm	\$24.85
GWR-86609	9mm	\$24.85
GWR-86610	10mm	\$27.05
GWR-86611	11mm	\$29.25
GWR-86612	12mm	\$31.35
GWR-86613	13mm	\$33.55
GWR-86614	14mm	\$35.55
GWR-86615	15mm	\$37.65
GWR-86616	16mm	\$39.55
GWR-86617	17mm	\$41.75
GWR-86618	18mm	\$46.15
GWR-86619	19mm	\$46.15
GWR-86621	21mm	\$55.65
GWR-86622	22mm	\$55.65
GWR-86624	24mm	\$65.25
GWR-86626	25mm	\$65.25

Item #	Size	Price
GWR-86641	5/16"	\$24.85
GWR-86642	11/32"	\$27.05
GWR-86643	3/8"	\$27.05
GWR-86644	7/16"	\$29.25
GWR-86645	1/2"	\$33.55
GWR-86646	9/16"	\$35.55
GWR-86647	5/8"	\$39.55
GWR-86648	11/16"	\$41.75
GWR-86650	13/16"	\$55.65
GWR-86651	7/8"	\$55.65
GWR-86652	15/16"	\$65.25
GWR-86653	1"	\$65.25

GW

90-Tooth Flex-Head Combination Ratcheting Wrenches



Item #	Size	Price
GWR-86708	8mm	\$35.15
GWR-86709	9mm	\$36.55
GWR-86710	10mm	\$38.05
GWR-86711	11mm	\$39.55
GWR-86712	12mm	\$40.95
GWR-86713	13mm	\$42.45
GWR-86714	14mm	\$43.95
GWR-86715	15mm	\$45.35
GWR-86716	16mm	\$46.85
GWR-86717	17mm	\$48.25
GWR-86718	18mm	\$49.75
GWR-86719	19mm	\$51.25
GWR-86721	21mm	\$67.35
GWR-86722	22mm	\$68.85
GWR-86724	24mm	\$79.05
GWR-86725	25mm	\$81.95

Item #	Size	Price
GWR-86741	5/16"	\$36.55
GWR-86742	11/32"	\$38.05
GWR-86743	3/8"	\$39.55
GWR-86744	7/16"	\$40.95
GWR-86745	1/2"	\$42.45
GWR-86746	9/16"	\$43.95
GWR-86747	5/8"	\$45.35
GWR-86748	11/16"	\$46.85
GWR-86749	3/4"	\$49.75
GWR-86750	13/16"	\$67.35
GWR-86751	7/8"	\$68.85
GWR-86752	15/16"	\$80.55
GWR-86753	1"	\$81.95

Combination Ratcheting Wrenches



12 Combination Ratcheting Wrench Sets



Item #	Head	Pieces	Range	
MLW-48-22-9529	Flex Head	7-Piece	8mm – 17mm	\$255.75
MLW-48-22-9513	Flex Head	15-Piece	8mm – 22mm	\$461.35
MLW-48-22-9413	Flex Head	15-Piece	1/4" – 1"	\$461.35
MLW-48-22-9416	Non-Flex Head	15-Piece	1/4" – 1"	\$275.35



48-22-9413

48-22-9513

48-22-9416

48-22-9529

GW GEARWRENCH

12 Combination Ratcheting Wrench Sets



Item #	Pieces	Range	Mechan.	Packaging	
GWR-9417	7-Pc	8 – 18mm	72-Tooth	Rack	\$76.45
GWR-9412	12-Pc	8 – 19mm	72-Tooth	Tray	\$153.05
GWR-85597	12-Pc	8 – 19mm	72-Tooth	Rack	\$271.35
GWR-86927	12-Pc	8 – 19mm	90°	Rack	\$196.45
GWR-9416	16-Pc	8 – 24mm	72-Tooth	Rack	\$211.05
GWR-86928	16-Pc	8 – 25mm	90°	Rack	\$321.05
GWR-86958	10-Pc	1/4" – 3/4"	90°	Rack	\$169.25
GWR-9317	7-Pc	5/16" – 3/4"	72-Tooth	Rack	\$76.45
GWR-9312	13-Pc	1/4" – 1"	72-Tooth	Rack	\$241.25
GWR-86959	14-Pc	1/4" – 1"	90°	Rack	\$275.65



9317/9417

86927

9416



9412



9312



86958

GW GEARWRENCH

12 72-Tooth Reversible Combination Ratcheting Wrench Sets



Item #	Piece Count	Size Range	
GWR-9620N	12-Piece	8mm – 19mm	\$241.25
GWR-9602N	16-Piece	8mm – 25mm	\$369.55
GWR-9533N	8-Piece	5/16" – 3/4"	\$168.35
GWR-9509N	13-Piece	5/16" – 1"	\$346.75



9602N

9509N

GW GEARWRENCH

12 Flex-Head Combination Ratcheting Wrench Sets



Item #	Pieces	Size Range	Mechan.	Packaging	
GWR-9901D	12-Pc	8 – 19mm	72-Tooth	Rack	\$342.25
GWR-86727	12-Pc	8 – 19mm	90°	Rack	\$339.25
GWR-86728	16-Pc	8 – 25mm	90°	Rack	\$506.05
GWR-86758	10-Pc	1/4" – 3/4"	90°	Rack	\$227.55
GWR-86759	14-Pc	1/4" – 1"	90°	Rack	\$414.25
GWR-9702D	13-Pc	5/16" – 1"	72-Tooth	Rack	\$346.75

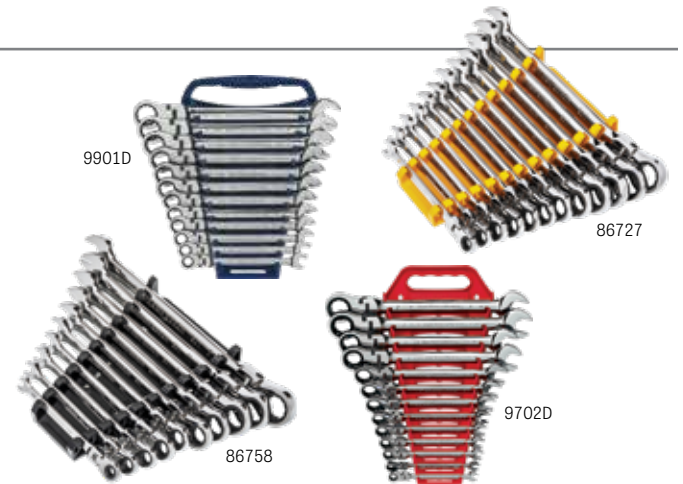

9901D

86727

86758

9702D

Double Box Wrenches

GW GEARWRENCH

GWR-86126 **\$497⁵⁵**
10-Pc 120XP™ Universal Spline XL Flex Head GearBox™ Ratcheting Metric Wrench Set
 • 10mm – 19mm



GW GEARWRENCH

85988



72-Tooth XL GearBox™ Double Box Ratcheting Wrench Sets

Item #	Piece Count	Size Range	
GWR-85988	12-Piece	8mm – 19mm	\$376.95
GWR-85998	9-Piece	5/16" – 3/4"	\$228.75

PLATINUM TECH

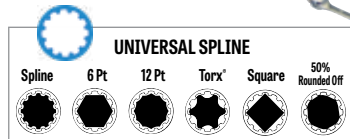

72-Tooth Extra Long Reversible Double Box Ratcheting Wrenches with Flex Heads

Item #	Piece Count	Size Range	
SETS			
ATD-PLT99652	2-Piece	21mm – 25mm	\$339.75
ATD-PLT99650	5-Piece	8mm – 19mm	\$381.95
ATD-PLT99750	4-Piece	5/16" – 3/4"	\$293.85
OPEN STOCK			
ATD-PLT99658	Single	8mm x 10mm	\$78.75
ATD-PLT99662	Single	12mm x 14mm	\$90.35
ATD-PLT99663	Single	13mm x 15mm	\$96.75
ATD-PLT99666	Single	16mm x 18mm	\$116.35
ATD-PLT99667	Single	17mm x 19mm	\$124.05
ATD-PLT99755	Single	5/16" x 3/8"	\$80.35
ATD-PLT99757	Single	7/16" x 1/2"	\$92.35
ATD-PLT99759	Single	9/16" x 5/8"	\$98.45
ATD-PLT99761	Single	11/16" x 3/4"	\$127.95

EZRED

EZR-NR5M **\$361⁰⁵**
5-Pc Extra Long Flex Head Spline Ratcheting Wrench Set
 • 8 x 10mm, 12 x 14mm, 13 x 15mm, 16 x 18mm, 17 x 19mm



VIM

VIM-FPRW100 **\$153¹⁵**
3-Pc Nano Flex 72-Tooth Ratcheting Wrench Set
 • Compact size ideal for use in tight spaces including dashboards, door panels, engine bays, or other areas with limited access
 • 7 x 9mm, 8 x 10mm, 11 x 13mm



VIM-WTC624 **\$85⁸⁵**
5-Pc Double Box Torx® Wrench Set
 • E6 x E8, E10 x E12, E14 x E16, E18 x E20, E22 x E24



Double Box 75° Offset Wrench Sets

Item #	Piece Count	Size Range	
KTO-1707SR	7-Piece	1/4" – 1-1/8"	\$117.85
KTO-1710MR	10-Piece	6mm – 32mm	\$180.55



KT PRO



SUNEX TOOLS

Half Moon Wrench Sets

Item #	Piece Count	Size Range	
SUN-9935M	5-Piece	8mm – 22mm	\$53.85
SUN-9935	5-Piece	5/16" – 7/8"	\$51.25



SUNEX TOOLS

S-Style Wrench Sets

Item #	Piece Count	Size Range	
SUN-9940M	5-Piece	10mm – 19mm	\$55.65
SUN-9940	5-Piece	5/16" – 3/4"	\$55.65



Open End Wrenches

SUNEX®
TOOLS

9914
9914M



Angled Head Open End Wrench Sets

Item #	Piece Count	Size Range	
SUN-9914MA	14-Piece	6mm – 19mm	\$117.45
SUN-9926	6-Piece	20mm – 25mm	\$96.45
SUN-9927	7-Piece	26mm – 32mm	\$147.45
SUN-9916	6-Piece	1-3/8" – 2"	\$233.05
SUN-9914A	14-Piece	3/8" – 1-1/4"	\$129.05



90122



Super Thin Open End Wrench Sets

Item #	Piece Count	Size Range	
GRI-90122	9-Piece	8mm – 32mm	\$55.75
GRI-90120	7-Piece	3/8" – 1-1/4"	\$52.65



Super Thin Open End Wrench Sets

Item #	Piece Count	Size Range	
VIM-MFW100	7-Piece	6mm – 19mm	\$150.45
VIM-MFW200	5-Piece	20mm – 32mm	\$292.65
VIM-SFW100	4-Piece	1/4" – 3/4"	\$97.55

**PLATINUM
TECH**



Super Thin Open End Wrench Sets

Item #	Piece Count	Size Range	
ATD-PLT99537	7-Piece	3/8" – 1-1/4"	\$165.95
ATD-PLT99589	9-Piece	8mm – 32mm	\$172.25

**PLATINUM
TECH**



Angled Head Open End Wrench Sets

Item #	Piece Count	Size Range	
ATD-PLT99400	14-Piece	3/8" – 1-1/4"	\$201.75
ATD-PLT99420	14-Piece	6mm – 19mm	\$154.55

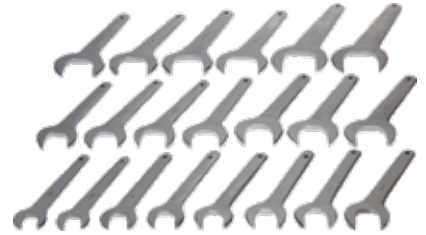

JUMBO Service Wrench Sets

Item #	Piece Count	Size Range	
GRI-90182	21-Piece	20mm – 50mm	\$271.15
GRI-90185	21-Piece	3/4" – 2"	\$271.15

Flare Nut Wrenches



Flex Head Flare Nut Line Wrench Kits

Item #	Piece Count	Size Range	
MUK-457 705	5-Piece	8mm – 12mm	\$160.55
MUK-457 705/SAE	5-Piece	5/16" – 1/2"	\$160.55

GW GEARWRENCH

Flex Head Flare Nut Wrench Sets



Item #	Piece Count	Size Range	
GWR-81911D	6-Piece	9mm – 21mm	\$211.05
GWR-81910	5-Piece	1/4" – 7/8"	\$183.65

GW GEARWRENCH

Flare Nut Wrench Sets

- 15° offset wrench heads



Item #	Piece Count	Size Range	
GWR-81906	6-Piece	9mm – 21mm	\$149.25
GWR-81907	6-Piece	1/4" – 7/8"	\$134.95

Crowfoot Wrenches

GW GEARWRENCH



81909



89119

3/8" Drive Crowfoot Wrench Sets

Item #	Piece Count	Size Range	
NON-RATCHETING			
GWR-81909	10-Piece	10mm – 19mm	\$137.75
GWR-81908	11-Piece	3/8" – 1"	\$153.05
RATCHETING			
GWR-89119	10-Piece	10mm – 19mm	\$155.85
GWR-89118	11-Piece	3/8" – 1"	\$171.05



90152

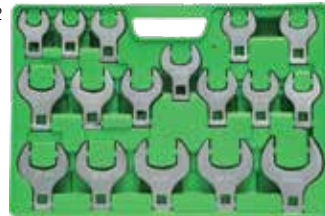

1/2" Drive JUMBO Crowfoot Wrench Sets

Item #	Piece Count	Size Range	
GRI-90152	16-Piece	20mm – 46mm	\$197.75
GRI-90150	14-Piece	1-1/16" – 2"	\$166.65

SUNEX TOOLS

OPEN END
9721A



FLARE NUT
9710M



Crowfoot Wrench Sets

Item #	Piece Count	Size Range	
3/8" Drive FLARE NUT Wrenches			
SUN-9710M	10-Piece	10mm – 19mm	\$61.85
SUN-9708	8-Piece	3/8" – 7/8"	\$47.85
1/2" Drive OPEN END Wrenches			
SUN-9730A	8-Piece	24mm – 32mm	\$104.95
SUN-9740A	7-Piece	34mm – 46mm	\$157.15
SUN-9720A	7-Piece	1" – 1-1/2"	\$104.75
SUN-9721A	14-Piece	1-1/16" – 2"	\$162.75
SUN-9722A	6-Piece	1-5/8" – 2-1/4"	\$121.45

PLATINUM TECH



PLT99450



PLT99370



PLT99380

Crowfoot Wrench Sets

Item #	Piece Count	Drive	Size Range	
ATD-PLT99450	11-Piece	3/8"	3/8" – 1"	\$102.95
ATD-PLT99370	15-Piece JUMBO	1/2"	1" – 2"	\$251.05
ATD-PLT99380	17-Piece JUMBO	1/2"	20mm – 46mm	\$272.25

VIM



SCF14

SCF38

SCF12

SCF12XL

Spring-Loaded Crowfoot Wrenches

Item #	Drive	Size Range	
VIM-SCF14	1/4"	5mm – 12mm	\$33.05
VIM-SCF38	3/8"	8mm – 17mm	\$41.35
VIM-SCF12	1/2"	14mm – 32mm	\$55.55
VIM-SCF12XL	1/2"	20mm – 48mm	\$117.65
VIM-SCF100	3-Piece Set: #SCF14, #SCF38, #SCF12		\$123.75

Adjustable Wrenches



Adjustable Wrenches

- Metric scale on one side and SAE scale on the other side

Item #	Length	
ATD-425	4-Piece Set: 6", 8", 10", 12"	\$88.25
ATD-426	6"	\$13.65
ATD-427	8"	\$18.55
ATD-428	10"	\$28.05
ATD-429	12"	\$38.65
ATD-415	15"	\$85.45
ATD-418	18"	\$134.95
ATD-424	24"	\$210.45



Adjustable Chrome Wrenches

- Metric scale on one side and SAE scale on the other side

Item #	Length	Jaw Capacity	
CRE-AC24VS	4"	1/2" (13mm)	\$21.25
CRE-AC26VS	6"	15/16" (24mm)	\$22.75
CRE-AC28VS	8"	1-1/8" (29mm)	\$25.75
CRE-AC210VS	10"	1-5/16" (34mm)	\$33.35
CRE-AC212VS	12"	1-1/2" (39mm)	\$37.85
CRE-AC215VS	15" (Tapered Handle)	1-11/16" (43mm)	\$69.75
CRE-AC218VS	18" (Tapered Handle)	2-1/16" (53mm)	\$90.95
CRE-AC224VS	24" (Tapered Handle)	2-7/16" (62mm)	\$197.15



Adjustable Wrenches

Item #	Length	Jaw Capacity	
KTO-3611-06RQ	6"	20mm / 23/32"	\$22.65
KTO-3611-08RQ	8"	25mm / 1"	\$24.75
KTO-3611-10RQ	10"	30mm / 1-3/16"	\$34.45
KTO-3611-12RQ	12"	35mm / 1-13/32"	\$45.65
KTO-3611-15HRQ	15"	43mm / 1-9/16"	\$93.25
KTO-3611-18HRQ	18" (Tapered Handle)	52mm / 2-3/16"	\$196.15
KTO-3611-24HRQ	24" (Tapered Handle)	62mm / 2-11/16"	\$309.95



VIS-2078706 **\$100¹⁵**

4-Pc Adjustable Wrench Tray Set

- Contains: 6", 8", 10" & 12"



SUN-9618A **\$85⁹⁵**

4-Pc Adjustable Wrench Set

- 6", 8", 10", 12"



Individual Adjustable Wrenches

Item #	Length	
SUN-961801A	6"	\$15.65
SUN-961802A	8"	\$20.15
SUN-961803A	10"	\$29.25
SUN-961804A	12"	\$38.25

Slim Jaw Adjustable Wrenches

- Rubber handle

Item #	Length	
GRI-87020	6"	\$24.95
GRI-87022	8"	\$34.95
GRI-87024	10"	\$46.45



Wide Jaw Adjustable Wrenches

- Rubber handle

Item #	Length	
SUN-9611	6"	\$41.65
SUN-9612	8"	\$51.95
SUN-9613	10"	\$72.75
SUN-9614	12"	\$104.05



Adjustable Construction Wrenches

- Laser etched fractional and metric scales on the head
- Continuous tapered handle for use with aligning bolt and rivet holes

Item #	Jaw Capacity	Length	
TIT-211	1-5/16"	10"	\$36.05
TIT-216	1-1/2"	12"	\$53.55



WRENCHES

Special Application Wrenches



CTA-8600 **\$57³⁵**
1/2" Drive - Small
 • Gland nuts: 1" to 3-3/4" / 25mm to 95mm (pin to pin)
 • Pinholes 1/4" or 7/32"

Adjustable Gland Nut Wrenches

- Fits hydraulic cylinders on vehicles with gland nuts
- Reverses to work on pinholes
- Use with ratchet or breaker bar

CTA-8605 **\$89²⁵**
3/4" Drive - Large
 • Gland nuts: 2" to 6" / 51mm to 152mm (pin to pin)
 • Pinholes 17/64" or 21/64"

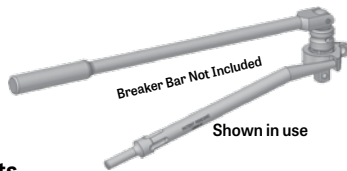

Kentucky Kicker Shockit Driver Kits

- Apply air hammer vibration and torque to any impact socket to remove most stubborn nuts and bolts
- Utilize air hammer and interlocking punch to access inaccessible fasteners
- Hypersonic vibration eliminates thread galling
- Square drive plug allows breaker bar and air hammer simultaneous operation
- Interlocking punch kit sold separately (#1910PK)



1940-3/8

Item #	Drive	
LOC-1940-3/8	3/8"	\$160.95
LOC-1940-1/2	1/2"	\$175.55
LOC-1940-3/4	3/4"	\$288.65

Shockit Crows Foot Sets for Hydraulic Line Fittings

- Compact design allows for use in tight places
- Uses the force and vibration of an air hammer to loosens difficult fittings
- Reaches difficult line nuts with interlocking offset punch



Kit for Automotive Hydraulic Line Fittings

- Loosens difficult hydraulic line fittings on steering, brake, A/C & fuel systems

Item #	Piece Count	Size Range	
LOC-1920	14-Piece	1/4" - 1"	\$216.45
LOC-1930	13-Piece	6mm - 17mm	\$197.55



IMPROVED

Kit for Heavy Duty Industrial Hydraulic Line Fittings

- Loosens difficult hydraulic fittings on tractors, forklifts and heavy equipment

Item #	Piece Count	Size Range	
LOC-1900	11-Piece	3/4" - 1-5/16"	\$230.85
LOC-1910	11-Piece	14mm - 24mm	\$230.85



IMPROVED

LOC-1910PK **\$269⁷⁵**

Shockit Punch Kit

- Offset design for greater access • Non-turning slots
- Includes:
 #1910PS - 5.5"
 #1910P - 11"
 #1910PL - 22"



Chain Wrenches



Chain Wrenches

Item #	Handle Length	Min./Max. Pipe Capacity	Chain Length	
TIT-21370	12"	2" / 4"	17"	\$54.05
TIT-21372	24"	2" / 6-1/2"	21.65"	\$87.35

Strap Wrenches



LIS-28500 **\$36⁷⁵**
Self-Tightening Strap Wrench

- Loosen or tighten cylindrical or rectangular objects
- Range from 1" to 6-5/8" round

TIT-21315 **\$28¹⁵**
12" Strap Wrench

- Use on pipes and fittings, filters, shafts, and irregular shapes
- Strap length: 34"
- Pipe capacity: 2"
- Tube capacity: 9"



Wrench Accessories



VIM-TWE26 **\$158³⁵**
Telescopic Wrench Extender, 18"-26"



Uni Wrench Extenders

- Helps loosen tight connections in hard to reach areas
- Fits Hex, TX and XZN wrenches



Item #	Description	Length	Max. Width	
MUK-745 099	Mini	9"	1/2"	\$64.45
MUK-745 100	Standard	13-3/8"	1"	\$82.05
MUK-745 101	Medium	17.7"	1-1/4"	\$133.55
MUK-745 102	Large	22-7/8"	1-13/16"	\$236.45



#745 099 is shown in use with an Allen key.

Pipe Wrenches

CRE-CPW12 **\$37⁸⁵**
**12" Long Self-Adjusting
 Dual Material Pipe Wrench**
 • Jaw capacity: 1.5" (38.1mm)



Cast Iron Pipe Wrenches

Item #	Length	Max. Cap.	
ATD-608	8"	1"	\$21.85
ATD-612	12"	1.5"	\$37.25
ATD-614	14"	2"	\$50.65
ATD-618	18"	2.36"	\$71.15
ATD-624	24"	3"	\$107.25
ATD-625	4-Pc Set: 12", 14", 18", 24"		\$205.55



Heavy-Duty Pipe Wrenches

Item #	Length	Max. Cap.	
TIT-21308	8"	1"	\$9.85
TIT-21310	10"	1-1/2"	\$13.65
TIT-21312	12"	1-3/4"	\$17.95
TIT-21314	14"	2"	\$23.85
TIT-21318	18"	2-1/2"	\$32.75
TIT-21324	24"	3"	\$56.35
TIT-21336	36"	5"	\$85.65
TIT-21337	48"	6"	\$149.85



Aluminum Pipe Wrenches

Item #	Length	Max. Cap.	
TIT-21330	10"	1-1/2"	\$26.85
TIT-21334	14"	2"	\$40.45
TIT-21338	18"	2-1/2"	\$56.35
TIT-21344	24"	3"	\$81.95
TIT-21346	36"	5"	\$163.15
TIT-21348	48"	6"	\$284.95



Steel Pipe Wrenches

Item #	Length	Max. Cap.	
MLW-48-22-7108	8"	1"	\$39.25
MLW-48-22-7110	10"	1-1/2"	\$42.25
MLW-48-22-7112	12"	2"	\$49.15
MLW-48-22-7114	14"	2"	\$56.05
MLW-48-22-7118	18"	2-1/2"	\$75.25
MLW-48-22-7124	24"	3"	\$110.95
MLW-48-22-7136	36"	5"	\$237.25
MLW-48-22-7148	48"	6"	\$378.25
MLW-48-22-7160	60"	8"	\$564.45



Cast Iron Pipe Wrenches

Item #	Length	Max. Cap.	
VIS-274105	8"	1"	\$33.95
VIS-274101	10"	1-1/2"	\$35.35
VIS-274106	12"	2"	\$44.75
VIS-274102	14"	2"	\$46.15
VIS-274103	18"	2-1/2"	\$57.95
VIS-274104	24"	3"	\$83.55
VIS-274107	36"	5"	\$171.65
VIS-274108	48"	6"	\$248.45



Aluminum Pipe Wrenches

Item #	Length	Max. Cap.	
VIS-2074110	10"	1-1/2"	\$58.75
VIS-2074112	12"	2"	\$79.75
VIS-2074114	14"	2"	\$83.05
VIS-2074118	18"	2-1/2"	\$104.15
VIS-2074124	24"	3"	\$161.55
VIS-2074136	36"	5"	\$252.85
VIS-2074148	48"	6"	\$495.25

Aluminum Pipe Wrenches

Item #	Length	Max. Cap.	
MLW-48-22-7210	10"	1-1/2"	\$58.25
MLW-48-22-7212	12"	2"	\$64.85
MLW-48-22-7214	14"	2"	\$71.95
MLW-48-22-7218	18"	2-1/2"	\$94.05
MLW-48-22-7224	24"	3"	\$145.75
MLW-48-22-7236	36"	5"	\$279.55
MLW-48-22-7248	48"	6"	\$551.45



Heavy-Duty Straight Pipe Wrenches

Item #	Length	Max. Cap.	
RGD-31010	10"	1-1/2"	\$48.95
RGD-31015	12"	2"	\$53.45
RGD-31020	14"	2"	\$58.15
RGD-31025	18"	2-1/2"	\$85.45
RGD-31030	24"	3"	\$128.55



Aluminum Straight Pipe Wrenches

Item #	Length	Max. Cap.	
RGD-31095	14"	2"	\$92.95
RGD-31100	18"	2-1/2"	\$117.45
RGD-31105	24"	3"	\$181.85
RGD-31110	36"	5"	\$335.35
RGD-31115	48"	6"	\$627.45

Aluminum Offset Head Pipe Wrenches

Item #	Length	Max. Cap.	
MLW-48-22-7184	14"	2"	\$102.35
MLW-48-22-7185	18"	2"	\$141.65
MLW-48-22-7182	24"	3"	\$212.55



MLW-48-22-7314 **\$142⁸⁵**

CHEATER Adaptable Pipe Wrench

- Two interchangeable threaded handles
- 3-length design: 10", 18", 24"
- Max. jaw cap.: 2-1/2"



L-Key Caddy Sets & T-Handle Hex Keys

LONG ARM L-KEY CADDY SETS

Item #	Description	Fastener End Type	Size Range	
GWR-83519	9-Pc Metric Hex L-Key Set	Hex	1.5mm – 10mm	\$9.55
GWR-83502	13-Pc SAE Hex L-Key Set	Hex	0.05" – 3/8"	\$18.05
GWR-83504	26-Pc SAE/Metric Hex L-Key Set	Hex	0.05" – 3/8" 1.5mm – 10mm	\$29.65
GWR-83521	9-Pc Metric Ball End Hex L-Key Set	Hex Ball Hex	1.5mm – 10mm	\$11.75
GWR-83524	13-Pc SAE Ball End Hex L-Key Set	Hex Ball Hex	0.05" – 3/8"	\$21.55
GWR-83505	26-Pc SAE/Metric Ball End Hex L-Key Set	Hex Ball Hex	0.05" – 3/8" 1.5mm – 10mm	\$37.35
GWR-83525	13-Pc SAE MAGNETIC Ball End Hex L-Key Set	Hex Ball Hex	0.05" – 3/8"	\$49.45
GWR-83526	22-Pc SAE/Metric MAGNETIC Ball End Hex L-Key Set	Hex Ball Hex	0.05" – 3/8" 1.5mm – 10mm	\$66.45
GWR-83522	9-Pc Torx® L-Key Set	Torx®	T8 – T40	\$13.75
GWR-83527	31-Pc MAGNETIC SAE/Metric Hex and Torx® L-Key Master Set	Hex Ball Hex Torx®	0.05" – 3/8" 1.5mm – 10mm T10 – T50	\$88.65



83504



83527



Magnetic End Holds fastener on end of key

T-HANDLE HEX KEY SETS

Item #	Description	Fastener End Type	Size Range	
GWR-83514	14-Pc SAE/Metric T-Handle Hex Key Set	Hex	3/32" – 1/4" 2.5mm – 10mm	\$49.65
GWR-83516	7-Pc Metric T-Handle Ball End Hex Key Set	Hex Ball Hex	2.5mm – 10mm	\$25.25
GWR-83520	8-Pc Metric T-Handle Ball End Hex Key Set – Metal Storage Stand	Hex Ball Hex	2mm – 10mm	\$54.75
GWR-83515	7-Pc SAE T-Handle Ball End Hex Key Set	Hex Ball Hex	3/32" – 1/4"	\$25.25
GWR-83523	10-Pc SAE T-Handle Ball End Hex Key Set – Metal Storage Stand	Hex Ball Hex	3/32" – 3/8"	\$62.65
GWR-83517	7-Pc Torx® T-Handle Hex Key Set	Torx®	T10 – T40	\$25.25



83523

GWR-83518 **\$63²⁵**
33-Pc Ratcheting T-Handle Set with Blow Mold Case
 Set includes 32 bits in SAE/Metric Hex, Torx®, Phillips®, Square

Long Arm Bits:

Hex: 3/8", 5/16", 1/4"
7mm, 8mm, 10mm,

Torx®: T25, T30, T40,
T45, T50

Phillips®: PH1, PH2

Square: SQ1, SQ2, SQ3,

Short Arm Bits:

Hex: 3/8", 5/16", 1/4"
7mm, 8mm, 10mm,

Torx®: T25, T30, T40,
T45, T50

Phillips®: PH1, PH2

Square: SQ1, SQ2, SQ3,



83516



L-Shaped Wrenches



Ball End Hex



Hex End



Ball End Torx®



Tamperproof Torx®

Long Length L-Wrenches

Item #	Tip	Sizing	Piece Count	Size Range	
BOS-10938	Ball End	Inch	10	1/16" – 1/4"	\$23.95
BOS-10937	Ball End	Inch	13	0.050" – 3/8"	\$37.75
BOS-10999	Ball End	Metric	9	1.5mm – 10mm	\$30.65
BOS-10990	Ball End	Metric	10	1.5mm – 10mm (Includes 7mm)	\$39.35
BOS-12138	Hex End	Inch	10	1/16" – 1/4"	\$11.85
BOS-12137	Hex End	Inch	13	0.050" – 3/8"	\$21.65
BOS-12195	Hex End	Metric	15	1.27mm – 10mm	\$34.55
BOS-11332	Ball Torx®	Torx®	8	T9 – T40	\$89.25
BOS-32434	Tamper Resistant Torx®	Torx®	8	TR9 – TR40	\$48.85

TITAN



TIT-12713 **\$43⁹⁵**
13-Pc Extra Long SAE Non Slip Hex L-Key Set
 • .05" – 3/8"



TIT-12714 **\$35⁴⁵**
9-Pc Extra Long Metric Non Slip Hex L-Key Set
 • 1.5mm – 10mm



TIT-12715 **\$48⁷⁵**
13-Pc Extra Long Non Slip Tamper Resistant Star L-Key Set
 • TR6 – TR50

T-Handle Wrenches



Ball End



Hex End



T-Handle Wrenches

Item #	Tip	Sizing	Piece Count	Size Range	
BOS-13190	Ball End	Inch	10	3/32" – 3/8"	\$121.95
BOS-13189	Ball End	Metric	8	2mm – 10mm	\$101.25
BOS-13390	Hex End	Inch	10	3/32" – 3/8"	\$107.45
BOS-13389	Hex End	Metric	8	2mm – 10mm	\$98.55



Hex



Torx



10-Pc T-Handle Wrench Sets

Item #	Tip	Sizing	Size Range	
ATD-574	Hex End	Inch	3/32" – 3/8"	\$15.55
ATD-575	Hex End	Metric	2mm – 10mm	\$15.65
ATD-576	Torx® End	Torx®	T7 – T40	\$12.85

Fold Up Wrenches



Ball End



Hex End



GorillaGrip® Fold Up Wrenches

Item #	Tip	Sizing	Piece Count	Size Range	
BOS-12894	Ball End	Inch	5	3/16" – 3/8"	\$29.75
BOS-12897	Ball End	Metric	5	5mm – 10mm	\$29.75
BOS-12589	Hex End	Inch	9	5/64" – 1/4"	\$14.65
BOS-12595	Hex End	Metric	6	3mm – 10mm	\$22.75

TITAN

Locking Fold Up Wrenches

• 3 locking positions:
 90°, 130° & 180°



Item #	Tip	Sizing	Piece Count	Size Range	
TIT-12770	Hex End	Inch	8	3/32" – 1/4"	\$23.35
TIT-12771	Hex End	Metric	8	1.5mm – 8mm	\$23.35
TIT-12772	Torx® End	Torx®	8	T9 – T40	\$23.35

Torque Wrenches



Split Beam Flexible Head Click Torque Wrenches

- Unique design does not require returning to zero before storage
- Quick adjustment • 15° swing arc
- 1 year limited warranty

Item #	Drive	Torque	Head Style	
TBQ-TWSB100F	3/8"	20-100 ft-lb	Flexible Head	\$224.95
TBQ-TWSB250F	1/2"	40-250 ft-lb	Flexible Head	\$249.95



TBQ-TWSB600F **\$718⁷⁵**

3/4" Drive Split Beam Click Type Extendable Torque Wrench with Detachable Ratchet

- 200-600 ft-lb
- Quick adjustment
- Push-through square drive ratchet head
- 1 year limited warranty



Micrometer Adjustable Torque Wrenches, Dual Scale



Item #	Drive	Torque	Nm	Length	
CDI-1501MRMH	1/4"	20-150 in-lb	2.8-15.3	10.15"	\$256.95
CDI-752MFRMH	3/8"	5-75 ft-lb	10.2-98.3	16"	\$279.65
CDI-1002MFRMH	3/8"	10-100 ft-lb	16.9-132.2	16"	\$209.75
CDI-2502MRMH	3/8"	30-250 in-lb	4.0-27.7	11.25"	\$265.65
CDI-7502MRMH	3/8"	100-750 in-lb	14.1-81.9	16"	\$279.65
CDI-10002MRMH	3/8"	150-1000 in-lb	9.8-110.2	16"	\$279.65
CDI-1503MFRMH	1/2"	20-150 ft-lb	34-197	19"	\$321.45
CDI-2503MFRMH	1/2"	30-250 ft-lb	47-332	24.4"	\$261.15
CDI-6004MFRMH	3/4"	100-600 ft-lb	162-813	42"	\$793.05
CDI-10005MFRMH	1"	200-1000 ft-lb	305-1322	70"	\$2400.05



SUN-40600 **\$813⁶⁵**

3/4" Drive Torque Wrench

- 110-600 ft-lb
- Desired torque is signaled by audible click and impulse



ATD-12505A **\$821⁴⁵**

3/4" Drive Micrometer Torque Wrench

- 100-600 ft-lb (152.6-830.6 Nm)
- Includes storage case



Micrometer Adjustable Click Torque Wrenches

- All torque wrenches come in a blow molded case

Item #	Drive	Torque	Increm.	Head Style	
PRC-M1R200HX	1/4"	30-200 in-lb	1 in-lb	Rigid	\$517.75
PRC-M2FR100FX	3/8"	20-100 ft-lb	0.5 ft-lb	Flex	\$553.45
PRC-M3R250FX	1/2"	30-250 ft-lb	1 ft-lb	Rigid	\$624.85



Split-Beam Click Torque Wrenches

- Not necessary to adjust to the lowest torque setting after use
- Setting the tool requires only fingertip force
- Torque setting locks on adjustable wrenches for repetitive applications
- All torque wrenches come in a blow molded case

Item #	Drive	Torque	Increm.	Head Style	
PRC-C2FR50F	3/8"	10-50 ft-lb	1 ft-lb	Flex	\$308.95
PRC-C2FR100F	3/8"	20-100 ft-lb	2 ft-lb	Flex	\$308.95
PRC-C3FR250F	1/2"	40-250 ft-lb	5 ft-lb	Flex	\$389.15



Split-Beam Click Torque Wrenches with Detachable Ratchet

- The #C4D600F36H Combo Kit includes #C4D600F Torque Wrench and #XT36H Breaker Bar Handle that extends from 31" to 41"
- All torque wrenches come in a blow molded case

Item #	Drive	Torque	Increments	
PRC-C4D600F	3/4"	200-600 ft-lb	10 ft-lb	\$899.25
PRC-C4D600F36H	3/4"	200-600 ft-lb	10 ft-lb	\$1015.15
PRC-C5D600F	1"	200-600 ft-lb	10 ft-lb	\$926.85

Torque Wrenches



Rugged Steel Grip Electronic Torque Wrenches with Angle Measurement

- Sealed head
- Dual progressive LEDs allows user to view active torque readings and to anticipate torque target for more accurate torque
- Automatically compensates for flex related torque variances
- Audible beep and handle vibrations
- 7 modes: ft-lb, in-lb, Nm, dNm, kg-cm, angle and torque then angle
- Fully programmable with 10 memory presets

Item #	Drive	Ft-lb	In-Lb	Nm	
WLM-2401EFRMH	1/4"	1-20 ft-lb	12-240 in-lb	1.36-27.12 Nm	\$905.45
WLM-1002EFRMH	3/8"	5-100 ft-lb	60-1200 in-lb	6.8-135.0 Nm	\$1086.45
WLM-2503EFRMH	1/2"	12.5-250 ft-lb	150-3000 in-lb	16.9-339 Nm	\$1303.75
WLM-6004ERMH	3/4"	30-600 ft-lb	360-7200 in-lb	40.7-813.5 Nm	\$2310.45



Flex Head Micrometer Torque Wrenches

- Thin profile, tear-drop head design

Item #	Drive	Torque	Nm	Increm.	
GWR-85086M	3/8"	5-75 ft-lb	10-105 Nm	.5 ft-lb	\$276.25
GWR-85087M	1/2"	30-250 ft-lb	54-353 Nm	2 ft-lb	\$309.55



Beam Torque Wrenches

Item #	Drive	Torque	Nm	Increments	
GWR-2955N	1/4"	0-80 in-lb	0-9 Nm	2.5 in-lb / .25 Nm	\$81.25
GWR-2956N	3/8"	0-800 in-lb	0-90 Nm	50 in-lb / 12 Nm	\$103.35
GWR-2957N	1/2"	0-150 in-lb	0-190 Nm	5 in-lb / 27 Nm	\$112.75

Fixed-Head 120XP Micrometer Torque Wrenches

- Thin profile, tear-drop head design

Item #	Drive	Torque	Nm	Increm.	
GWR-85171	1/4"	30-200 in-lb	3.95-23.16 Nm	1 in-lb	\$301.55
GWR-85176	3/8"	10-100 ft-lb	20.3-142.4 Nm	1 ft-lb	\$283.65
GWR-85181	1/2"	30-250 ft-lb	54.2-352.6 Nm	2 ft-lb	\$354.85

Fixed-Head Micrometer Torque Wrenches

- Thin profile, tear-drop head design

Item #	Drive	Torque	Nm	Increm.	
GWR-85060M	1/4"	30-200 in-lb	3.95-23.16 Nm	1 in-lb	\$229.15
GWR-85061M	3/8"	30-250 in-lb	4.52-29.38 Nm	1 in-lb	\$221.05
GWR-85062M	3/8"	10-100 ft-lb	20.3-142.4 Nm	1 ft-lb	\$214.45
GWR-85063M	1/2"	20-150 ft-lb	33.9-210.2 Nm	1 ft-lb	\$253.55
GWR-85066M	1/2"	30-250 ft-lb	54.2-352.6 Nm	2 ft-lb	\$232.35
GWR-85065M	3/4"	100-600 ft-lb	153-830 Nm	2.5 ft-lb	\$1043.75

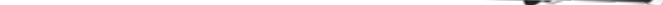

Flex-Head 120XP Electronic Torque Wrenches with Angle Measurement

- 15° flex head
- Multiple alerts when the target torque is reached: handle vibrates, buzzer sounds and LED light shows solid
- Five torque measurement units: Nm, ft-lbs, in-lbs, kgf-m, kgf-cm

Item #	Drive	Torque	Nm	Increm.	
GWR-85194	1/4"	2-20 ft-lb	2.7-27.0 Nm	0.1 ft-lb	\$427.95
GWR-85195	3/8"	10-100 ft-lb	13.5-135 Nm	0.1 ft-lb	\$446.35
GWR-85196	1/2"	25-250 ft-lb	34-340 Nm	0.1 ft-lb	\$507.65

Electronic Torque Wrenches

- Five torque measurement units: Nm, ft-lbs, in-lbs, kgf-m, kgf-cm

Item #	Drive	Torque	Nm	Increm.	
GWR-85076	3/8"	7.4-99.6 ft-lb 88.5-1,194 in-lb	10-135 Nm	0.1 ft-lb 1 in-lb 0.1 Nm	\$380.45
GWR-85077	1/2"	25.1-250.8 ft-lb 300-3,008 in-lb	30-340 Nm	0.1 ft-lb 1 in-lb 0.1 Nm	\$405.65

Electronic Torque Wrenches with Angle Measurement

- 15° flex head
- Five torque measurement units: Nm, ft-lbs, in-lbs, kgf-m, kgf-cm

Item #	Drive	Torque	Nm	Increm.	
GWR-85078	3/8"	10-100 ft-lb 88.5-1,194 in-lb	10-135 Nm	0.1 ft-lb 1 in-lb 0.1 Nm	\$466.65
GWR-85079	1/2"	25-250 ft-lb 300-3,000 in-lb	34-340 Nm	0.1 ft-lb 1 in-lb 0.1 Nm	\$530.45

Torque Wrenches

GEARWRENCH

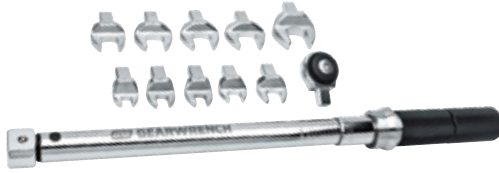

12-Piece Interchangeable Torque Wrench Sets

- 9mm x 12mm adapter size

Item #	Drive	Nm	Set Range	
GWR-89450	1/4"	5-25 Nm	5/16"-13/16"	\$511.85
GWR-89451	1/4"	5-25 Nm	8mm-17mm	\$488.15
GWR-89452	3/8"	20-100 Nm	5/16"-13/16"	\$570.95
GWR-89453	3/8"	20-100 Nm	8mm-17mm	\$547.35



PLATINUM TECH

Break-Back Style Torque Wrenches

- Won't allow over torquing
- Comes in a blow molded case



Item #	Drive	Torque	Nm	
ATD-PLT12600	3/4"	150-600 ft-lb	200-800 Nm	\$689.05
ATD-PLT12750	1"	200-750 ft-lb	300-1,000 Nm	\$824.85

CP86 Series – Cordless Digital Torque Wrenches

- Precise, compact and lightweight
- ±4% accuracy (6 sigma)
- Extended operation
- Models connected to your smart device with the CPLinQ App allow for tool maintenance (C, CQ), job control (C, CQ), quality process reports (CQ)
- Delivered with:
 - (2) 36V 2.5Ah batteries,
 - (1) Charger, (1) Power cord,
 - (1) Storage case



CPLinQ
Download the App to your smart device



Item #	CPT-8613	CPT-8613C	CPT-8613CQ	CPT-8626	CPT-8626C	CPT-8626CQ	CPT-8641	CPT-8641C	CPT-8641CQ	CPT-8681
Version	Standalone	Connected for tool maintenance	Connected for maintenance & quality process	Standalone	Connected for tool maintenance	Connected for maintenance & quality process	Standalone	Connected for tool maintenance	Connected for maintenance & quality process	Standalone
CPLinQ App		✓	✓		✓	✓		✓	✓	
Square Drive	3/4" Drive			1" Drive			1" Drive			1-1/2" Drive
Min./Max. Torque	220-960 ft-lb (300-1300 Nm)			520-1910 ft-lb (700-2600 Nm)			740-3020 ft-lb (1000-4100 Nm)			1470-5970 ft-lb (2000-8100 Nm)
Max. Speed	10 RPM			5 RPM			3 RPM			1.2 RPM
Weight	11.7 lbs			15.9 lbs			25.13 lbs			36.4 lbs

Torque Wrenches

NRB-120110 **\$886⁵⁵**

3/4" Drive Heavy-Duty Break-Back Industrial Torque Wrench

- Compact, 2-piece design for easy transport & storage
- Range: 150-600 ft-lb and 200-800 Nm
- Replaceable ratchet assembly
- Easier to calibrate, easier to read and set



Break-A-Way Torque Wrenches

- "Break Back" action provides an unmistakable signal that can be seen and felt when the set torque is reached
- Comes in a blow molded case



Item #	Drive	Torque	Nm	
AME-67601	1"	150-600 ft-lb	200-800 Nm	\$796.95
AME-67751	1"	200-750 ft-lb	300-1,000 Nm	\$841.95

ESCO



14" Long Extensions for Break-Back Style Torque Wrenches

- Won't allow over torquing
- Designed to torque a complete range of wheel types and sizes
- Use on single and dual wheels



Item #	Drive	
ESC-10007-EXT	3/4"	\$177.05
ESC-10010-EXT	1"	\$184.65

Torque Wrenches



AME-67170 **\$182⁵⁵**
5-in-1 Preset Torque Wrench - 1/2" Drive
 • 5 preset values: 80, 100, 120, 140 and 160 ft-lb
 • Accuracy ± 4%

FREE!
 While quantities last

Buy #AME-67170 and obtain #AME-67800 for free: 1/2" Drive Spline Plus™ Impact Socket Set, 17mm, 19mm, 21mm.



ATD-12555 **\$196⁹⁵**
1/2" Drive 5-in-1 Pre-Set Torque Wrench
 • 5 pre-set torque values: 80, 100, 120, 140, and 160 ft-lb
 • Accurate to within ± 4%
 • Length: 18.5"

Torque Multipliers

Torque Multipliers
 • 4 to 1 ratio



WILLIAMS Made in USA

Item #	Max. Output	Input Female Square	Output Male Square	
WLM-JHWTM-750LW	1,000 ft-lb	1/2"	3/4"	\$749.15
WLM-JHWTM-1000	2,000 ft-lb	3/4"	1"	\$930.05
WLM-JHWTM-1500	4,000 ft-lb	1"	1-1/2"	\$2306.55

Torque Multipliers
 • 4 to 1 ratio

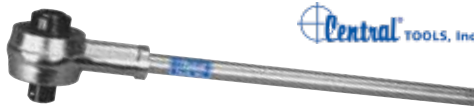

Central TOOLS, INC.

Item #	Max. Output	Input Female Square	Output Male Square	
CEN-6380	1,000 ft-lb	1/2"	3/4"	\$894.55
CEN-6387	2,000 ft-lb	3/4"	1"	\$1148.85



3-Pc Torque Multiplier Set
 • 5 to 1 ratio

Item #	Max. Output	Input Female Square	Output Male Square	
KTO-34688	2,000 ft-lb	3/4"	1"	\$1129.75

Torque Meters

VIM-DATM1238 **\$234³⁵**
Digital Torque & Angle Meter, 1/2" & 3/8" Drive

- Designed to turn any ratchet or breaker bar into a torque/angle measuring tool
- Can be used to recalibrate any type of torque wrench
- Max. torque reading: 270 lbf-ft
- Max. angle measure: 720°
- 30 memory settings for torque reading and 30 settings for angle reading
- Units of measure: lbf-ft, lbf-in, kgf-cm, Nm
- Accuracy: CW: ± 1.5%, CCW: ± 2.5%, Angle: ± 2°



Torque Testers

AME-67015 **\$751⁹⁵**
Digital Torque Tester

- Get immediate feedback on the accuracy of your manual torquing device
- Torque range: 25-250 ft-lb
- Accuracy to +/- 1%
- Easily switch between ft-lb, Nm, in-lb
- Compatible with 1/4", 3/8", and 1/2" drive wrenches
- 120V power source
- Large display with back light
- Stores up to 99 previous test results for future auditing



Torque Screwdrivers



Torque Screwdrivers
 • Accuracy: +/- 6%



Item #	Description	Range	Increm.	
GWR-89621	1/4" Torque Screwdriver	1-6 Nm	0.1	\$294.45
GWR-89622	1/4" Torque Screwdriver	21-165 in-oz	0.01	\$284.35
GWR-89623	1/4" Torque Screwdriver	5-25 in-lb	0.5	\$288.65
GWR-89624	1/4" Torque Screwdriver	10-50 in-lb	1	\$204.75
GWR-89625	1/8" Drive Mini Torque Screwdriver	5-60 cNm	0.5	\$195.05

Torque Angle Gauges

LIS-28100 **\$70⁴⁵**
Torque Angle Meter

- Commonly used for tightening head bolts and other bolts where a torque angle is required
- Use with 1/2" drive



OTC-4554 **\$31⁶⁵**
Torque Angle Gauge

- Required when servicing many late model engines that use torque-to-yield fasteners
- Measures angle of rotation
- Has 1/2" male and female square drives



Kits de tournevis



MAY-66306 **\$158⁸⁵**
**Tournevis combinés,
 10 pièces**

- Phillips: #1, #2, #3
- Pointe plate: 7/32", 1/4", 5/16", 3/8"



SUN-1112SS **\$111⁴⁵**
**Tournevis combinés,
 12 pièces**

- Pointe plate: 1/4", 5/16", 3/8"
- Phillips: #1, #2, #3, #4
- Pointe plate d'ébéniste: 3/16"



WLM-JHW100P-8MD **\$123⁶⁵**
Tournevis combinés, 8 pièces

- (3) Pointe plate: 1/4", 5/16", 3/8"
- (3) Phillips: #1, #2, #3
- (2) Pointe d'électricien: 3/16"



SUN-1120SS **\$145⁶⁵**
**Tournevis combinés,
 20 pièces**

- Pointe plate: 1/4", 5/16", 3/8"
- Phillips: #0, #1, #2, #3
- Torx®: T10, T15, T20, T25, T27, T30
- Pointe plate d'ébéniste: 1/8", 5/32", 3/16"



SUN-118SS **\$71⁷⁵**
**Tournevis combinés,
 8 pièces**

- Pointe plate: 1/4", 5/16"
- Phillips: #1, #2, #3
- Pointe plate d'ébéniste: 3/16"



ATD-6256 **\$140⁴⁵**
Kit de 18 tournevis combinés

- (11) Pointe plate: 1/8", 3/16", 1/4", 5/16", 3/8"
- (5) Phillips: #0, #1, #2
- (2) Torx®: T15, T20



GWR-80050H **\$79⁵⁵**
**Tournevis combinés,
 6 pièces**

- (2) Phillips: #1, #2
- (4) Pointe plate: 1/8", 1/4", 5/16", 3/8"



ATD-6198 **\$82⁸⁵**
**Tournevis combinés
 avec trousse d'embouts**

- (19) Tournevis: pointe plate, Phillips, Torx®
- (1) Poinçon conique
- (1) Tire-clous
- (1) Porte-embout
- Embouts: Phillips, Torx®, pointe plate, Pozi®



GWR-80051H **\$130⁰⁵**
**Tournevis combinés,
 12 pièces**

- (6) Phillips: #0, #1, #2, #3
- (5) Pointe plate: 1/8", 1/4", 5/16", 3/8"
- (1) Pointe plate d'ébéniste: 3/16"



TIT-17242 **\$83⁰⁵**
Tournevis, 42 pièces

- (17) Tournevis avec embouts magnétiques: pointe plate, Phillips, carré, Torx®
- (1) Tire-clous
- (1) Rallonge emmanchée
- (4) Pics de précision
- (9) Douilles 1/4" SAE
- (9) Douilles 1/4" métriques
- (1) Bac magnétique

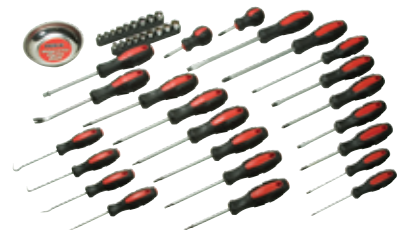

GWR-80066H **\$162²⁵**
**Tournevis combinés,
 20 pièces**

- (9) Phillips: #00, #0, #1, #2, #3
- (9) Pointe plate: 3/16", 1/4", 5/16", 3/8", 1.5mm, 2mm, 2.5mm
- (2) Torx®: T20, T25



Screwdriver Sets

GEARWRENCH



GWR-80060H **\$122⁴⁵**

10-Pc Combination Screwdriver Set

- (2) Phillips: #1, #2
- (4) Slotted: 1/8", 3/16", 1/4", 5/16"
- (4) Pozidriv®: #0, #1, #2, #3



MUELLER KUPFER

MUK-706 400 **\$114⁸⁵**

4-Pc 12" XL Hex Tip Screwdriver Set

- 3mm, 4mm, 5mm 6mm



MUELLER KUPFER

MUK-706 300 **\$174⁵⁵**

6-Pc 12" XL Torx® Screwdriver Set

- T10, T15, T20, T25, T27, T30



GEARWRENCH

GWR-80071H **\$84¹⁵**

7-Pc Torx® Screwdriver Set

- Torx®: T10 - T40



GEARWRENCH

GWR-80064H **\$64²⁵**

3-Pc 18" Long Torx® Screwdriver Set

- Torx®: T15, T20, T25

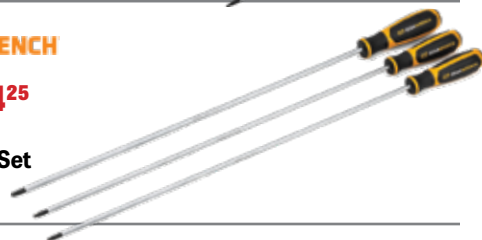

CalYan

6-Pc X-Long Torx Screwdriver Sets

- 15-3/4" long
- T10, T15, T20, T25, T27, T30



Item # Description

CAL-912	Torx	\$84.85
CAL-917	Tamperproof Torx	\$88.35

GEARWRENCH

GWR-80065H **\$53⁵⁵**

4-Pc Square Screwdriver Set

- Square: #0, #1, #2, #3



Multi-Bit Screwdrivers



GWR-82779 **\$137⁷⁵**

56-Pc Ratcheting Screwdriver Set

- (10) SAE and (10) metric sockets
- (6) Slotted: 4-6.5mm, 5/32"-1/4"
- (4) Phillips®: #0 #1 #2 #3
- (12) Hex: 3-8mm, 1/8"-5/16"
- (8) Torx®: T8-T40



GEARWRENCH



GWR-80191R **\$36¹⁵**

19-in-1 Ratcheting Multi-Bit Driver

- Shaft converts to 3 nutdriver sizes: 1/4", 5/16", 7/16"
- (6) Hex: 5/16"-1/4"
- (3) Phillips®: #1 #2 #3
- (3) Slotted: 3/16", 1/4", 5/16"
- (2) Square: #1, #2 • (2) Torx®: T15, T20



GEARWRENCH



GWR-82781 **\$27⁵⁵**

7-Pc Ratcheting GearDriver® Set

- Phillips: #0, #1, #2
- Slotted: 5/32", 3/16", 1/4"



GEARWRENCH



WILLIAMS

WLM-JHWWRS-1 **\$69⁵⁵**

9" Long Magnetic Ratcheting Screwdriver

- Easy bit storage in handle
- Includes 5 bits: 2 slotted, #1, #2 Phillips, and T-15 TORX®



Made in USA



TIT-16092 **\$18⁶⁵**

26-Pc Ratcheting Precision Screwdriver

- 1/8" shank
- (7) Phillips
- (5) Slotted
- (5) SAE Hex
- (5) Star
- (2) Tri-Wing



TITAN



TIT-16028 **\$44⁹⁵**

26-Pc Precision Bit and Driver Set

- 1/8" shank
- Specialized tip for smart phones
- (4) Phillips • (2) 5-Lobe • (5) Slotted
- (6) Star • (7) Hex • (1) Magnetic bit holder



TITAN

SCREWDRIVERS & BITS

Multi-Bit Screwdrivers

MEGAPRO®



Made in USA

MGP-151NAS-C **\$34⁸⁵**

The Original 15-in-1 Multi-Bit Screwdriver

- (7) Double-ended bits • Slotted: 4, 6 • Phillips: #0, #1, #2, #3
- Torx®: T10, T15, T20, T25 • Square: #0, #1, #2, #3
- **BONUS:** 1/4" Hex driver



Made in USA

MGP-151TP-C **\$47⁶⁵**

The Tamperproof 15-in-1 Screwdriver

- (7) Double-ended bits
- Tamperproof Hex: 1/8", 9/64", 5/32", 3/16"
- Tamperproof Torx®: TP10, TP15, TP20, TP25, TP27, T30
- Tamperproof Spanner: 6, 8, 10, 12
- **BONUS:** 1/4" Hex driver



Made in Canada

MGP-211R1C36RD-C **\$57¹⁵**

Automotive Ratcheting Magnetic Screwdriver

- (12) 1-inch HSS bits
- Slotted: 4, 6
- Phillips: #1, #2, #3
- Torx®: T10, T15, T20, T25, T27, T30
- Square: #2

SUN-6N1SPH **\$17⁶⁵**

6-in-1 Interchangeable Screwdriver

SUNEX
TOOLS



TITAN



TIT-12217 **\$31³⁵**

10" High-Torque Flex-Head Ratcheting Screwdriver

- (3) Phillips: #1, #2, #3 • (4) Slotted: 5/32", 3/16", 1/4", 9/32"
- (2) Star: T15, T20 • (1) Square: SQ2
- Magnetic bit holder • Reversible ratcheting design
- Bit storage in handle

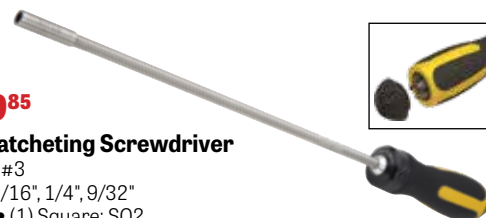

TIT-12218 **\$39⁸⁵**

18" Extra-Long Ratcheting Screwdriver

- (3) Phillips: #1, #2, #3
- (4) Slotted: 5/32", 3/16", 1/4", 9/32"
- (2) Star: T15, T20 • (1) Square: SQ2
- Magnetic bit holder • Reversible ratcheting design
- Bit storage in handle

Torque Screwdrivers

GW GEARWRENCH



89621



89625

Torque Screwdrivers

- Accuracy: +/- 6%

Item #	Description	Range	Increm.	
GWR-89621	1/4" Torque Screwdriver	1 – 6 Nm	0.1	\$294.45
GWR-89622	1/4" Torque Screwdriver	21 – 165 in-oz	0.01	\$284.35
GWR-89623	1/4" Torque Screwdriver	5 – 25 in-lb	0.5	\$288.65
GWR-89624	1/4" Torque Screwdriver	10 – 50 in-lb	1	\$204.75
GWR-89625	1/8" Drive Mini Torque Screwdriver	5 – 60 cNm	0.5	\$195.05

Impact Drivers

Lisle



LIS-29200 **\$67²⁵**

3/8" Hand Impact Tool Set

- Loosens rusted, frozen nuts, bolts and screws
- Can be reversed to tighten
- Unique design delivers over 200 ft. lbs. of "Shock Torque"
- Set includes: #1, #2, #3, #4 Phillips bits, and 3/8" straight slot bit

Lisle



LIS-60530 **\$58³⁵**

Small Fastener Remover

- For use with a pneumatic impact tool
- Kit includes: Phillips #1, #2, #3, #4 and a straight slot bit

TOOL AID®
PROFESSIONAL AUTOMOTIVE TOOLS



SGT-14950 **\$68⁸⁵**

Impact Driver Set

- Phillips: #2, #3
- Slotted bits: 5/16", 3/8" in 1-3/8" and 3-1/8" lengths

TITAN



TIT-16007 **\$15⁸⁵**

1/4" Drive Impact Driver

- Set includes:
- (1) 3" Phillips: #2
 - (2) 2" Phillips: #1 and #2
 - (1) 2" Slotted bit: 3/16"
 - (1) 2" Square bit: SQ2

Hose Clamp Drivers

TITAN

TIT-12229 **\$13³⁵**

Flexible Hose Clamp Driver

- (1) 1/4" drive x 11" flexible driver
- (2) 1/4" drive, 6 pt. sockets: 1/4" & 5/16"
- Works with mini & standard hose clamps



Nut Drivers/Nut Setters

**SUNEX[®]
TOOLS**

SUN-9933 **\$100⁴⁵**

14-Pc Impact Ready Magnetic Nut Setters Set

- 6mm to 14mm
- 1/4" to 1/2"



TITAN

TIT-16239 **\$18²⁵**

3-Pc Impact Grade Slotted Wing Nut Driver Set

- Designed for use with wing nuts, eye screws, and C hooks
- Sizes: 7/16", 1/2", 15/16"
- Shank: 1/4" Hex
- Overall lengths: 2-9/16" and 2-15/16"
- For use with all types of drills and impact drivers



TITAN

6-Pc Easy Read Nut Driver Sets

- 1/4" Shank
- Overall length: 2-1/4"

Item #	Size Range	
TIT-15223	8mm – 15mm	\$40.35
TIT-15222	1/4" – 9/16"	\$40.35



VIM

12-Pc Magnetic and Hollow Body Nut Setting Tools

- Power drive shank

Item #	Size Range	
VIM-NSM100	8mm – 14mm	\$73.85
VIM-NS100	1/4" – 9/16"	\$71.75



Bit Drivers

TIT-11317 **\$33⁸⁵**

4" Long 1/4" Drive Aluminum Swivel Head Micro Bit Driver

- 90-tooth
- Magnetic bit retention
- Includes PH2 bit

TITAN



LANG Made in USA

LAN-5221 **\$34³⁵**

5-Pc Fine Tooth Bit Driver Set

- (1) 15" offset wrench
- Bit Sizes: #1 & #2 Phillips; 1/4" and 9/32" Slotted
- Use with any 1/4" drive bit as a ratcheting screwdriver or a 1/4" adapter



SUN-9728 **\$38³⁵**

1/4" Drive Mini Magnetic Ratcheting Bit Driver

**SUNEX[®]
TOOLS**



VIM-HBR4 **\$29⁰⁵**

1/4" Hex Bit Ratchet

VIM



VIM-HBR12 **\$100⁵⁵**

12" Long 1/4" Hex Bit Flex Head Ratchet Wrench

- Removable 1/4" square drive adapter
- Works with all 1/4" Hex bits & 1/4" drive sockets

EZR-4S04 **\$70⁹⁵**

4" Long Quarter Stick Ratchet

- 1/4" combination magnetic bit drive and 1/4" square drive ends
- Reversible
- Push-button quick release
- 180° flex heads for multiple angles

EZRED



EZR-4SS8 **\$65²⁵**

8" Long S-Shaped Quarter Stick Ratchet

- 1/4" square socket and 1/4" magnetic bit drives
- Reversible • Requires only 5° to move fasteners

EZR-4S12L **\$85⁹⁵**

12" Locking Flex Head Quarter Stick Ratchet

- 1/4" combination magnetic bit drive and 1/4" square drive ends
- Reversible • Push-button quick release
- 180° flex heads lock in 10 different positions



SCREWDRIVERS & BITS

Bit Sets

TITAN



TIT-16061 **\$23⁵⁵**

61-Pc Bit Set

- (6) Phillips
- (5) Slotted
- (13) Star
- (12) Hex
- (6) Pozi
- (7) Tamperproof Star
- (6) Tamperproof Hex
- (5) Spanner
- 2-1/2" Magnetic bit holder

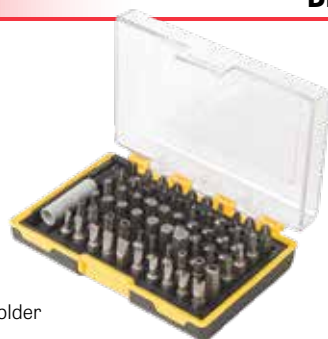

TIT-16148 **\$87⁰⁵**

148-Pc Master Security Bit Set

- Phillips, Slotted, Square, Star, Tamperproof Star, Hex, Tamperproof Hex, Pozi, Clutch, Spline, Spanner, Tri-Wing and Quad-Wing



TIT-16251 **\$113⁸⁵**

50-Pc Torsion Impact Bit Set

- Phillips, Slotted, Square, Star, Hex bits
- Adapters, chucks, socket drivers



ATD-551 **\$161³⁵**

50-Pc Torsion Impact Bit Set

- Includes: Phillips, Hex, Torx, Slotted, Robertson, adapters, chucks and socket drivers



IRWIN



IRW-IWAF1234 **\$101⁸⁵**

34-Pc Power Bit Set

- Torx®: T8-T30
- Phillips: #1, #2, #3
- Pozidriv: #1, #2, #3
- Socket adapters: 1/4", 3/8", 1/2"
- Magnetic nut drivers: 1/4", 5/16", 3/8"
- Quick change bit holders: 2.5" & 6"



VIM-IMPACT-8TX **\$25⁴⁵**

8-Pc Impact Torx® Bits

- T25 - T55



VIM-IMPACT-8IP **\$28⁴⁵**

8-Pc Impact Torx® Plus Bits

- IP20 - IP55



LIS-26000 **\$30⁴⁵**



7-Pc Tamper Resistant Torx® Bit Set

- T-10 to T-40, plus 1/4" bit holder

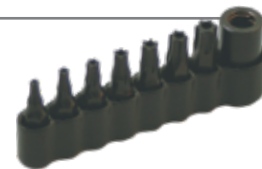

TIT-16113 **\$19²⁵**

13-Pc Tamper Resistant Star Bit Set on Magnetic Rack

- 1/4" and 3/8" drive bit holders • (11) bits: TR8 - TR55



4-Pc XZN Triple Square Bit Sets

- M6, M8, M10, M12



Item #	Drive	Length	
TIT-16161	3/8"	30mm	\$6.45
TIT-16164	1/2"	75mm	\$13.25



33-Pc Security Bit Set

- (9) Tamper-resistant star: TR8, TR10, TR15, TR20, TR25, TR27, TR30, TR35, TR40
- (12) Tamper-resistant Hex
Metric: 2, 2.5, 3, 4, 5, 6mm
SAE: 5/64", 3/32", 7/64", 1/8", 9/64", 5/32"
- (4) Spanner: #4, #6, #8, #10
- (4) Tri-wing: #1, #2, #3, #4
- (3) Torq: #6, #8, #10
- (1) 2.5" Magnetic bit holder

Item #	Length	
TIT-16633	2"	\$17.85
TIT-16533	5"	\$41.35

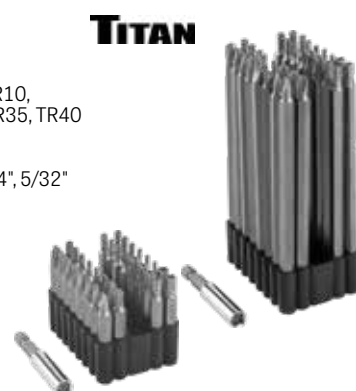

ATD-549 **\$53¹⁵**

90-Pc Master Bit Set with Ratcheting Screwdriver

- Soft grip, stubby, reversible ratcheting screwdriver
- Magnetic bit holder
- Socket bit holder



Bit Sets

PROTO



PRO-J61390 **\$195⁸⁵**
91-Pc Multibit Set with Ratcheting Screwdriver and T-Handle

SUNEX TOOLS



SUN-9729 **\$117⁵⁵**
208-Pc 1/4" Drive Master Bit Set



SUN-9726 \$59¹⁵
38-Pc Mini Ratchet and Bit Set



SUN-9732 **\$106⁷⁵**
44-Pc Socket & Bit Set with 1/4" Drive Mini Dual Flex Head Ratchet
 • Spline sockets: 5/32" to 1/2" (4-13mm)
 • (7) Phillips: #1, #2, #3
 • (4) Slotted: 1/8" to 1/4"
 • (8) Tamperproof Torx®: T8H to T40H
 • (11) Hex: 5/32" to 1/4", 1.5mm to 6mm



VIM-VHC77 **\$243⁰⁵**
77-Pc Half Cut Bit Set
 • Lowest profile bits
 • Impact rated



VIM-FRBS89 **\$254²⁵**
89 Piece Master Bit Set with 1/4" Flex Ratchet



Milwaukee

MLW-48-32-4018 **\$23⁰⁵**
18-Pc SHOCKWAVE™ Impact Driver Bit Set

- Magnetic bit holder
- Includes:
 - Phillips #2 - (1) 1" long, (2) 2" long
 - Square #1 - (1) 1" long, (1) 2" long
 - Square #2 - (3) 1" long, (6) 2" long, (1) 3.5" long
 - Square #3 - (1) 1" long, (1) 2" long



Bit Holders

TITAN

TIT-16020 **\$9⁰⁵**
2-1/4" Quick-Release Magnetic Bit Holder



IRWIN.

1/4" Lock-n-Load® Quick-Change Bit Holders

Item #	Length	
IRW-4935704	6"	\$18.45
IRW-4935705	12"	\$20.55



VIM

1/4" Hex Locking Bit Holder Sockets

Item #	Square Drive	
VIM-HL414	1/4"	\$12.85
VIM-HL614	3/8"	\$14.05



VIM-UPH4 **\$34⁰⁵**
Universal Power Hex Driver

- 1/4" Square drive
- 1/4" Locking Hex bit holder
- Can be used with hand tools or power tools



Quick Change Impact Adapter

- Converts square drive impact wrench to hex drive
- Quick release collar

TITAN

Item #	Size	
TIT-12034	3/8" sq. to 1/4" hex	\$18.35
TIT-12039	1/2" sq. to 1/4" hex	\$21.45



Mixed Pliers



CNL-GB-3 **\$114⁵⁵**

3-Pc Pliers Set

Set includes:

- #430 – 10" Tongue & Groove Pliers
- #338 – 8" XLT™ Diagonal Cutting Pliers
- #3017 – 8" Long Nose Pliers



CNL-TOOL ROLL-1 **\$196¹⁵**

5-Pc Tool Roll Pliers Set

Tool roll includes:

- #526 6" slip joint pliers
- #447 8" diagonal lap joint pliers
- #420 9-1/2" multi tongue & groove pliers
- #317 8" long nose pliers
- #909 9-1/2" crimping pliers



CNL-TOOL ROLL-2 **\$201⁰⁵**

5-Pc Technician's Pliers Set

Tool roll includes:

- #420 tongue and groove pliers
- #909 crimping and cutting tool
- #447 diagonal cutters
- #317 long nose pliers
- #426 tongue and groove pliers



CNL-TOOL ROLL-3 **\$164¹⁵**

5-Pc Professional Pliers Set

Tool roll includes:

- #430° tongue and groove pliers
- #420° tongue and groove pliers
- #337 cutting pliers
- #3017 long nose pliers
- #526 slip joint pliers



VIS-2078702 **\$28⁹⁵**

2-Pc ProPlier Set

- 6" Slip Joint
- 6" Long Nose



VIS-2078707 **\$85⁹⁵**

4-Pc Traditional Pliers Tray Set

- 6" Diagonal
- 6" Slip Joint
- 8" Long Nose
- 10" Groove Joint



VIS-2078708 **\$121⁴⁵**

5-Pc Traditional Pliers Set

- 6" Slip Joint
- 6" Diagonal
- 8" Lineman
- 10" Adjustable Wrench
- 10" Groove Joint



ATD-827 **\$137⁰⁵**

7-Pc Multi-Purpose Pliers Set

- 6" Needle nose pliers with side cutter
- 8" HD diagonal cutting pliers
- 8" Linesman pliers
- 8" Slip joint pliers
- 10" Crimping & cutting pliers
- 10" Tongue & groove pliers
- 12" Tongue & groove pliers



SUN-3610V **\$112⁸⁵**

5-Pc Multi-Purpose Pliers Set

- 8" Long nose pliers
- 8" Lineman's pliers
- 8" Slip joint pliers, bent jaw
- 8" Bent jaw cutter
- 12" Tongue & groove pliers, straight jaw



MLW-48-22-6331 **\$63⁷⁵**

3-Pc Comfort Grip Pliers Kit

- 8" Long Nose Pliers (#48-22-6101)
- 7" Diagonal Cutting Pliers (#48-22-6107)
- 10" Straight-Jaw Pliers (#48-22-6310)



GWR-82202-06 **\$107³⁵**

3-Piece Electrician's Pliers Set

- 9" Linesman Pliers (#82181)
- 8" Diagonal Cutting Pliers (#82179)
- 8" Long Nose Pliers (#82177)



GWR-82203C-06 **\$131⁷⁵**

4-Pc Mixed Pliers Set

- 8" Diagonal Cutting Pliers (#82179C)
- 8" Long Nose Pliers (#82177C)
- 8" Slip Joint Pliers (#82175C)
- 10" V-Jaw Tongue & Groove Pliers (#82172C)



GWR-82204C-06 **\$211⁵⁵**

6-Pc Mixed Pliers Set

- 8" Diag. Cutting Pliers (#82179C)
- 8" Long Nose Pliers (#82177C)
- 8" Slip Joint Pliers (#82175C)
- 9" Linesman Pliers (#82181C)
- 10" Straight Jaw Tongue & Groove Pliers (#82170C)
- 12" Straight Jaw Tongue & Groove Pliers (#82171C)



Mixed Pliers



KNI-9K 00 80 156 US **\$219⁴⁵**

3-Pc Top Selling Pliers Set

- 87 01 180: 7-1/4" Cobra® water pump pliers
- 86 01 180: 7-1/4" Pliers wrench
- 82 01 200: 8" TwinGrip slip joint pliers



KNI-9K 00 80 157 US **\$210⁹⁵**

3-Pc Professional Pliers Set

- #74 01 200: 8" High leverage diagonal cutter
- #09 01 240: 9-1/2" High leverage lineman's pliers
- #87 01 250: 10" Cobra® water pump pliers

Slip Joint Pliers

Slip Joint Pliers with Wire Cutting Shear

Item #	Length	
CNL-526	6.5"	\$21.45
CNL-528	8"	\$22.15



8" Long TwinGrip Slip Joint Pliers for Stripped Screws and Bolts

- Slim head design
- Large front and side gripping capacity: 5/32" - 7/8" (4mm - 22mm)



Cushion Grip Slip Joint Pliers with Wire Cutter

- 2 jaw positions

Item #	Length	Cut Capacity	Jaw Capacity	
GWR-82174C	6"	AWG12	1.25"	\$27.15
GWR-82175C	8"	AWG11	1.5"	\$30.05



Adjustable / Tongue & Groove Pliers



CNL-GLS-1 **\$58³⁵** 2-Pc GripLock® Tongue & Groove Pliers Set

- #GL10 - 9.5" Griplock®
- #GL12 - 12.5" Griplock®



CNL-PC-1 **\$156⁹⁵** 4-Pc Pro's Choice Tongue & Groove Pliers Set

- #424 - 4.5" • #426 - 6.5"
- #440 - 12" • #460 - 16.5"



SPEEDGRIP™ Straight Jaw Tongue & Groove Pliers

Item #	Length	Capacity	
CNL-GS-1X	2-Piece Set 8" & 10"	1.2" & 2"	\$98.15
CNL-428X	8"	1.2"	\$47.15
CNL-430X	10"	2"	\$51.05
CNL-440X	12"	2.32"	\$57.95



VISE-GRIP® GrooveLock Pliers

- Press-n-slide button adjusts jaws 2X faster

Item #	Model #	Length	Jaw Type	Jaw Capacity	
VIS-2078108	GV8®	8"	V-Jaw	1-3/4"	\$26.45
VIS-2078110	GV10®	10"	V-Jaw	2-1/4"	\$31.75
VIS-2078112	GV12®	12"	V-Jaw	2-3/4"	\$38.05



VISE-GRIP® Groove Joint Pliers

Item #	Model #	Length	Jaw Type	Jaw Capacity	
VIS-2078510	GJ10®	10"	Curved	2"	\$20.55
VIS-2078512	GJ12®	12"	Curved	2-1/4"	\$24.25



Ream & Punch™ Straight-Jaw Pliers

Item #	Length	Jaw Capacity	
MLW-48-22-6312	12"	2-3/4"	\$25.25
MLW-48-22-6316	16"	3"	\$58.05
MLW-48-22-6320	20"	5-1/2"	\$80.95

Adjustable / Tongue & Groove Pliers



Swedish Pipe Wrenches with Rapid Adjustment

- S-type jaw provides 3-contact point grip that securely handles round, square, hex and flat workpieces

Item #	Length	Max. Capacity	
KNI-83 61 010	13"	1-5/8"	\$139.05
KNI-83 61 015	17"	2-3/8"	\$208.15
KNI-83 61 020	22"	2-3/4"	\$314.95



86 04 100



86 04 100



KNIPEX Pliers Wrenches

- Perfect for gripping, holding, pressing and bending
- Smooth, parallel jaws with high degree of pressure
- Push-button adjustment directly on the workpiece (#86 04 100 is one-handed slide adjustment, no push-button)
- Pinch guard prevents fingers from being pinched

Item #	Length	Hex	Adjustments	
KNI-86 04 100	4"	3/4" (21mm)	10	\$87.05
KNI-86 03 180	7-1/4"	1-3/8" (35mm)	13	\$104.95
KNI-86 03 250	10"	2" (52mm)	19	\$121.45
KNI-86 03 300	12"	2-3/8" (60mm)	22	\$156.05



87 00 100



87 00 100



Cobra® High-Tech Water Pump Pliers

- Works on square, hex, round and flat workpieces
- Gripping surfaces with hardened teeth
- Push-button adjustment directly on the workpiece (#87 00 100 is one-handed slide adjustment, no push-button)
- Self-locking on pipes and nuts
- Pinch guard prevents fingers from being pinched

Item #	Length	Hex	Pipe	Adjustm.	
KNI-87 00 100	4"	1" (28mm)	1" (28mm)	11	\$60.45
KNI-87 01 125	5"	1-1/16" (27mm)	1-1/16" (27mm)	13	\$63.35
KNI-87 01 180	7-1/4"	1-27/64" (36mm)	1-1/2" (42mm)	18	\$68.75
KNI-87 01 250	10"	1-3/4" (46mm)	2" (50mm)	25	\$72.95
KNI-87 01 300	12"	2-3/64" (60mm)	2-3/4" (70mm)	30	\$101.75
KNI-87 01 400 US	16"	3-3/4" (95mm)	3-1/2" (90mm)	27	\$175.95
KNI-87 01 560 US	22"	4-3/4" (120mm)	4-1/2" (115mm)	20	\$263.05



Cobra® QuickSet High-Tech Water Pump Pliers

- Fully open, push, grab!
- Fast adjustment on the workpiece by sliding the pliers handle
- Self-locking on pipes and nuts
- The pliers stay locked in place and can only be readjusted by pressing the button and resetting



Item #	Length	Hex	Pipe	Adjustm.	
KNI-87 21 250	10"	1-3/4" (46mm)	2" (50mm)	25	\$76.15
KNI-87 21 300	12"	2-3/64" (60mm)	2-3/4" (70mm)	25	\$112.75



KNIPEX Cobra® ES Extra-Slim High-Tech Water Pump Pliers

- Long, narrow jaws
- Good access to the workpiece due to the very slim construction of head and joint area
- Grips flat material due to three-point rest
- Adjustment at the touch of a button directly on the workpiece
- Self-locking on pipes and nuts
- Pinch guard prevents fingers from being pinched



Item #	Length	Hex	Pipe	Adjustm.	
KNI-87 51 250	10"	1-3/8" (35mm)	1-1/4" (32mm)	19	\$77.65



KNIPEX Raptor™ Pliers

- Reliable and tight gripping of rounded, rusty or overly painted nuts and screws
- Quick tightening of nuts and bolts using ratchet action
- Ideal for work on vehicle brake systems
- Self-locking from 11/16" (17mm)
- Adjustment at the touch of a button directly on the workpiece
- Pinch guard prevents fingers from being pinched



Item #	Length	Hex	Adjustments	
KNI-87 41 250	10"	3/8" – 1-1/4" (10mm – 32mm)	15	\$81.55



KNIPEX Alligator® XL Pipe Wrench & Water Pump Pliers

- 50% lighter in weight than comparable wrenches
- Gripping surfaces with hardened teeth
- Self-locking on pipes and nuts
- Robust adjustment mechanism, dirt resistant, easy to clean
- Pinch guard prevents fingers from being pinched



Item #	Length	Hex	Pipe	Adjustm.	
KNI-88 01 400	16"	3-3/4" (95mm)	3-1/2" (90mm)	11	\$152.95

Adjustable / Tongue & Groove Pliers

KNI-00 20 72 V04 XS 2-Pc Mini Pliers Set in Belt Pouch

Includes:

- #87 00 100:
4" Cobra® XS
Water Pump Pliers,
1" gripping capacity
- #86 04 100:
4" Pliers Wrench XS,
3/4" gripping capacity

\$184²⁵

NEW



KNI-00 20 06 US1 **\$231²⁵**

3-Pc Cobra® High-Tech Water Pump Pliers Set

- 7-1/4", 10", and 12"

KNI-9K 00 80 149 US

8-Pc Cobra® Water Pump Pliers Set

Includes:

- #87 00 100 (4")
- #87 01 125 (5")
- #87 01 150 (6")
- #87 01 180 (7-1/4")
- #87 01 250 (10")
- #87 01 300 (12")
- #87 01 400 US (16")
- #87 01 560 US (22")

\$810³⁵

NEW



CHAN NEL LOCK

Nutbuster® Tongue & Groove Pliers



Item #	Length	Capacity	Adjust.	
CNL-410	9.5"	1.12"	4	\$36.45
CNL-414	13.5"	2"	6	\$59.25



CHAN NEL LOCK

Straight Jaw Tongue & Groove Pliers



Item #	Length	Capacity	Adjust.	
CNL-424	4.5"	0.5"	3	\$30.55
CNL-426	6.5"	0.87"	5	\$26.45
CNL-428	8"	1.5"	4	\$31.55
CNL-420	9.5"	1.5"	5	\$31.85
CNL-430	10"	2"	7	\$33.15
CNL-440	12"	2.25"	7	\$37.55
CNL-460	16.5"	4.25"	8	\$62.45
CNL-480	20.5"	5.5"	12	\$122.25



CHAN NEL LOCK

V-Jaw Tongue & Groove Pliers



Item #	Length	Capacity	Adjust.	
CNL-422	9.5"	1.5"	5	\$32.35
CNL-432	10"	2"	7	\$34.85
CNL-442	12"	2.25"	7	\$36.25



CHAN NEL LOCK

Code Blue® Tongue & Groove Pliers



Item #	Length	Capacity	Adjust.	
CNL-420CB	9.38"	1.5"	5	\$46.55
CNL-430CB	10.5"	2"	7	\$47.75



GW GEARWRENCH

Straight Jaw AutoBite Tongue & Groove Pliers

- Self-locking jaws



82592C

FIT BULL AUTO BITE

Item #	Length	Capacity	Jaw Positions	
GWR-82592C	10"	2.2"	25	\$42.95
GWR-82594C	4-Piece Set: 6", 8", 10", 12"			\$121.65

GW GEARWRENCH

FIT BULL

Cushion Grip



Dipped
Handles



Straight Jaw Tongue & Groove Pliers

Item #	Handles	Length	Capacity	Adjust.	
GWR-82169C	Cushion Grip	8"	1.6"	8	\$32.95
GWR-82170C	Cushion Grip	10"	2.1"	8	\$35.75
GWR-82166	Dipped Handles	16"	4.2"	8	\$65.85

GW GEARWRENCH

FIT BULL

Cushion Grip



Dipped
Handles



V-Jaw Tongue & Groove Pliers

Item #	Handles	Length	Capacity	Adjust.	
GWR-82168C	Cushion Grip	8"	1.6"	8	\$32.95
GWR-82172C	Cushion Grip	10"	2.1"	8	\$35.75
GWR-82173C	Cushion Grip	12"	2.6"	8	\$41.55
GWR-82167	Dipped Handles	16"	4.2"	8	\$65.85

Cutting Pliers

SUNEX
TOOLS

SUN-3710V **\$50⁵⁵**
11" Heavy Duty Cutting Pliers



GEARWRENCH **PIBULL**

Diagonal Cutting Pliers

- 20° head angle for flush cutting
- Reaming edges for deburring pipes



Item #	Length	Cut Capacity	
GWR-82178C-06	6"	AWG8	\$31.95
GWR-82183C-06	7"	AWG8	\$34.55
GWR-82179C-06	8"	AWG7	\$36.45

CHANNELOCK 

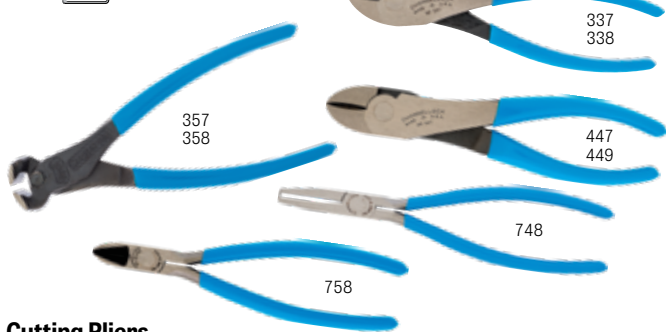

Cutting Pliers

Item #	Description	
CNL-337	7" High Leverage Diagonal Lap Joint Cutting Pliers	\$39.85
CNL-338	8" High Leverage Diagonal Lap Joint Cutting Pliers	\$43.55
CNL-357	7.5" End Cutting Pliers	\$46.15
CNL-358	8" End Cutting Pliers	\$52.65
CNL-447	8" High Leverage Curved Diag. Lap Joint Cutting Pliers	\$50.95
CNL-449	9.5" High Leverage Curved Diag. Lap Joint Cutting Pliers	\$57.95
CNL-748	8" End Cutting Long Reach Pliers	\$50.75
CNL-758	7.5" Flush Cutting Long Reach Pliers	\$63.95

IRWIN
WISE-GRIP

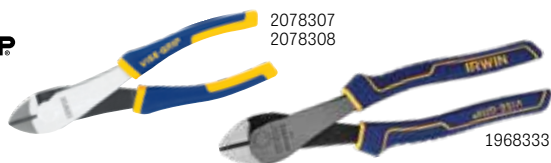

WISE-GRIP® Diagonal Cutting Pliers

Item #	Model #	Length	
VIS-2078307	DIA7®	7"	\$24.45
VIS-1968333		8"	\$46.55
VIS-2078308	DIA8®	8"	\$28.35

KNI-68 01 200 **\$57⁹⁵**

8" End Cutting Nippers

- Soft wire: 5/32" (4mm)
- Medium wire: 9/64" (3.5mm)
- Hard wire: 7/64" (2.8mm)



74 01 200



74 01 250

74 21 200
74 21 250



74 91 250

Cutting Pliers

Item #	Description	Med.	Hard	Piano	
KNI-74 01 200	8" Diagonal Cutters	11/64" (4.2mm)	1/8" (3mm)	3/32" (2.5mm)	\$68.35
KNI-74 01 250	10" Diagonal Cutters	3/16" (4.6mm)	9/64" (3.5mm)	1/8" (3mm)	\$89.65
KNI-74 21 200	8" Diag. Cutters, 12° Angle	11/64" (4.2mm)	1/8" (3mm)	3/32" (2.5mm)	\$71.15
KNI-74 21 250	10" Diag. Cutters, 12° Angle	3/16" (4.6mm)	9/64" (3.5mm)	1/8" (3.0mm)	\$92.25
KNI-74 91 250	10" Center Cutters	13/64" (5.2mm)	5/32" (3.8mm)	9/64" (3.6mm)	\$111.45

KNI-00 20 05 US **\$212¹⁵**

3-Pc High Leverage Diagonal Cutters Set

- 6" & 10" straight cutters
- 8" angled cutter



KNI-9K 00 80 129 US **\$172⁸⁵**

2-Pc High Leverage Diagonal Cutter Set

- 10" diagonal cutters



Diagonal Cutting Pliers

- Integrated reaming head and fish tape puller

Item #	Description	
MLW-48-22-6106	6" Cushion Grip	\$25.15
MLW-48-22-6107	7" Cushion Grip	\$27.25
MLW-48-22-6108	8" Cushion Grip 	\$29.85
MLW-48-22-6508	8" Dipped Handles	\$26.45

Milwaukee

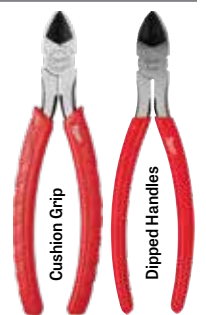

MLW-48-22-6102 **\$44⁴⁵**

9" Ironworker's Pliers

- For cutting and twisting rebar tie wire
- Iron carbide edge for 2X more cutting life



Long Nose / Needle Nose Pliers

IRWIN
WISE-GRIP

2078226
2078228



2078218

WISE-GRIP®
Long Nose Pliers with Cutting Edge

Item #	Model #	Length	Nose	
VIS-2078218	LN8®	8"	Straight	\$24.45
VIS-2078226	BN6®	6"	Bent	\$23.45
VIS-2078228	BN8®	8"	Bent	\$26.35

CHANNEL LOCK

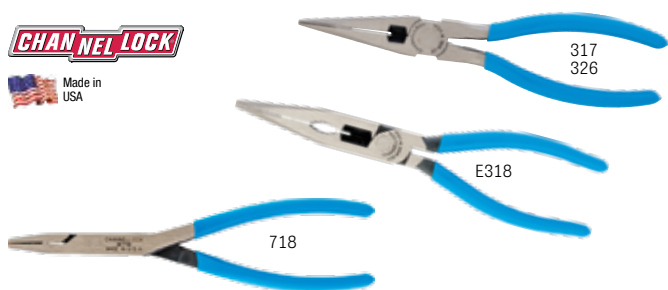

317
326

E318

718

Long Nose Pliers with Side Cutter

Item #	Description	
CNL-326	6" XLT™ Side Cutting Long Nose Pliers	\$43.15
CNL-317	8" Side Cutting Long Nose Pliers with Cutter	\$44.35
CNL-E318	8" XLT™ Long Nose Pliers with Cutter	\$45.75
CNL-718	8" Duck Bill Long Reach Pliers	\$39.25

GEARWRENCH
PROBULL



Long Nose Pliers with Wire Cutter

• Bolt grip zone for turning nuts and fasteners

Item #	Length	Cut Capacity	
GWR-82176C-06	6"	AWG11	\$31.35
GWR-82177C-06	8"	AWG11	\$35.95

Milwaukee



48-22-6101

48-22-6501

8" Long Nose Pliers

• Wire cutter
• Reaming head
• Fish tape puller

Item #	Handle	
MLW-48-22-6101	Cushion Grip	\$32.15
MLW-48-22-6501	Dipped Handle	\$26.45

EZR

EZR-KWP2 **\$37¹⁵**

2-Pc Kiwi Pliers Set

• Includes 6" short nose and 8" long nose



Long Nose Plier Sets

• Serrated jaws

Item #	Length	Content	
TIT-60769	11"	5-Piece Set: Straight, Flat, 45°, 90°, Large Hose Grip Pliers	\$68.45
TIT-60770	11"	3-Piece Set: Straight, 45°, 90°	\$40.85
TIT-60787	16"	3-Piece Set: Straight, 45°, 90°	\$56.95

GEARWRENCH

GWR-82106-06 **\$71⁵⁵**
2-Pc 16.8" Long Double-X™ Long Nose Pliers Set

• 45° and straight tip pliers



SUNEX
TOOLS

4-Pc Long Reach Needle Nose Plier Sets

• 90°, 45°, straight, 20° offset

Item #	Length	
SUN-3600V	11"	\$109.95
SUN-3706V	16"	\$136.15



ATD



ATD-814 **\$96⁵⁵**
4-Pc 11" Long Needle Nose Pliers Set
• Straight, 45°, 90° and S-type offset pliers



ATD-863 **\$101²⁵**
3-Pc 16" Long Needle Nose Pliers Set
• Straight, 45°, 90°

Cable Cutters

IRWIN
VISE-GRIP

VIS-2078328 **\$32²⁵**

8" Cable Cutting Pliers

- Cuts copper and aluminum wire
- Cuts up to 3/0 fine-stranded copper battery cable



CHAN
NET LOCK



CNL-911 **\$57⁷⁵**

9.5" Cable Cutter

- Cuts up to 4/0 and 2/0 copper
- Not for steel or ACSR



TOOL AID
PROFESSIONAL AUTOMOTIVE TOOLS

SGT-18830 **\$42⁶⁵**

9-3/8" Cable Cutter

- For cutting 8 - 2/0 AWG stranded copper wire



KLEIN
TOOLS

KLE-63050 **\$69⁵⁵**

9.5" High Leverage Cable Cutter

- Cutting capacity: 4/0 aluminum; 2/0 soft copper; 100-pair 24 AWG communications cable
- Jaw capacity: 1.06"



TITAN

TIT-11468 **\$57⁶⁵**

7" Wire Rope and Cable Cutter

- Cutting capacity: 3/16"
- For left and right-handed users
- For shearing stainless steel wire rope and cable, steel wire, aluminum wire, copper wire, and soft wire



KNI-95 61 190 **\$119⁵⁵**

7-1/2" Wire Rope Shears

- Cable: 9/32" (7mm)
- Wire rope: 1/4" (6mm)
- Medium wire: 5/32" (4mm)
- Piano wire: 7/64" (2.5mm)



EZR-B798 **\$102⁴⁵**

Heavy-Duty Cable Cutters

- Cuts cable up to 3/4" in diameter
- 14" long insulated handles
- Carbon steel blades
- For strand copper only



MLW-48-22-6104 **\$37⁴⁵**

9.5" Cable Cutting Pliers

- Cuts up to 4/0 aluminum
- Cuts up to 2/0 copper



Bolt Cutters



Angled
Blades

Straight
Blades

CoBolt® Compact Bolt Cutters



Recessed
Straight Blades

Item #	Length/ Blades	Soft	Medium	Hard	Piano	
KNI-71 01 160	6-1/4" Straight	13/64" (5.3mm)	11/64" (4.4mm)	1/8" (3.2mm)	1/8" (3mm)	\$89.15
KNI-71 01 200	8" Straight	1/4" (6mm)	13/64" (5.2mm)	5/32" (4.2mm)	9/64" (3.6mm)	\$109.65
KNI-71 01 250	10" Straight	—	7/32" (5.5mm)	5/32" (4.2mm)	5/32" (4mm)	\$137.95
KNI-71 21 200	8" 20° Angle	1/4" (6mm)	13/64" (5.2mm)	5/32" (4.2mm)	9/64" (3.6mm)	\$130.55
KNI-71 31 200	8" Straight	1/4" (6mm)	13/64" (5.2mm)	5/32" (.24mm)	9/64" (3.6mm)	\$117.05
KNI-71 31 250	10" Recessed Straight	—	1/4" (6mm)	11/64" (4.3mm)	11/64" (4.2mm)	\$144.15

RIDGID

Bolt Cutters



Item #	Length	Soft	Medium	Hard	
RGD-14218	19"	3/8" (9.5mm)	5/16" (7.9mm)	1/4" (6.4mm)	\$147.15
RGD-14223	24"	7/16" (11mm)	3/8" (9.5mm)	5/16" (7.9mm)	\$187.35
RGD-14228	31"	1/2" (12.7mm)	7/16" (11mm)	3/8" (9.5mm)	\$216.05
RGD-14233	38"	9/16" (14.3mm)	1/2" (12.7mm)	7/16" (11mm)	\$276.35
RGD-14238	44"	11/16" (17.5mm)	9/16" (14.3mm)	1/2" (12.7mm)	\$338.85

ECLIPSE

Heavy-Duty Tubular Handle Bolt Cutters

Item #	Length	Cutting Cap.	
ECL-ETBC14	14"	3/16"	\$28.25
ECL-ETBC18	18"	1/4"	\$32.85
ECL-ETBC24	24"	5/16"	\$44.95
ECL-ETBC30	30"	3/8"	\$62.75
ECL-ETBC36	36"	7/16"	\$80.15



Snips



WIS-WC5LN \$53⁰⁵
10" Long 5-Blade HVAC Hand Crimper
 • Compound action jaw



9" Long Hand Seamers

- Used for bending and flattening sheet metal
- 1/4" depth markings from 1/4" to 1-1/4"
- Produces a permanent, tight-fitting seam

Item #	Jaw Width	Handle	
WIS-WS3N	3"	Straight	\$60.65
WIS-WS6N	6"	Straight	\$103.15
WIS-WS4N	3"	Offset	\$69.75



WIS-CTFDUCTC \$60⁶⁵
17.5" Long Compound Action Flex Duct Cutter

- Dual-cut technology provides a serrated and smooth cutting surface
- Cutter integrated into the base for easy cutting of the hard still wire within the flex duct



Precision Sheet Metal Fabrication Tools

- Cuts 18 gauge sheet metal & 22 gauge stainless steel



LEN-22209C5 \$53⁴⁵
5 Blade Crimper



LEN-22211N2 \$53⁴⁵
1" V Notcher



Snips

Item #	Description	Size	
Aviation Snips			
IRW-2073111	Cuts left and straight	10"	\$26.45
IRW-2073112	Cuts right and straight	10"	\$26.45
IRW-2073113	Cuts straight and wide curves	10"	\$26.45
Offset Snips			
IRW-2073211	Cuts straight and angles or curves left	9.5"	\$29.65
IRW-2073212	Cuts straight and angles or curves right	9.5"	\$29.65
Tinner Snips			
IRW-22010	Cuts straight and wide curves	10"	\$26.85
IRW-22012	Cuts straight and wide curves	12-3/4"	\$33.95
IRW-23012	Cuts straight and tight curves	12-3/4"	\$34.45



TIT-11463 \$64⁸⁵
3-Pc Aviation Snip Set
 • Right, straight and left cut snips



Metalmaster® Compound Action Aviation Snips

- 9-3/4" long
- Cuts up to 18 gauge low carbon, rolled steel



Item #	Description	
WIS-M123R	3-Pc Set: Includes M1R, M2R, M3R	\$75.85
WIS-M1R	Cuts straight and left	\$30.35
WIS-M2R	Cuts straight and right	\$30.35
WIS-M3R	Cuts straight, left and right	\$30.35

Wire Stripping-Cutting-Crimping Pliers



CNL-909 **\$47⁵⁵**



9.5" Long Wire Cutter/Crimper

- Crimps and cuts insulated and non-insulated solderless connections and terminals
- Cuts 10-22 AWG wire



VIM-WS57 **\$47¹⁵**



7" Long Automotive Electrical Wiring Tool

- Twist, cut, strip, and crimp insulated and non-insulated connectors



KLE-1005 **\$61⁶⁵**



9-3/4" Crimping and Cutting Tool for Connectors

- Crimps 10 to 22 AWG insulated and non-insulated terminals



KLE-1009 **\$38⁹⁵**



7-3/4" Long-Nose Wire Stripper/Crimper

- Strips and cuts: 10-20 AWG solid, 12-22 AWG stranded wire
- Crimping capacity: 10-22 AWG insulated and non-insulated connectors
- Screw shearing: 6-32 and 8-32
- Do not use to cut steel wire



KLE-11046 **\$32⁰⁵**



6-1/4" Long Wire Stripper/Cutter

- Strips and cuts: 16-26 AWG stranded
- Wire looping and bending holes
- Do not use for cutting steel wire or bolts

KLE-11054EINS **\$97¹⁵**

8" Long 1,000 Volt-Rated Insulated Wire Stripper/Cutter

- Strips and cuts: 8-16 AWG solid, 10-18 AWG stranded
- Screw shearing: #6-32 and #8-32
- Do not use for cutting steel wire
- VDE certified; meets or exceeds ASTM F1505 and IEC 60900 standards for insulated tools



MLW-48-22-6579 **\$30³⁵**



9" Multi-Purpose Wire Stripper with Crimper

- Crimps insulated and non-insulated terminals
- Strips 10-20 AWG solid wire and 12-22 AWG stranded wire
- Cuts bolt sizes: 4-40, 5-40, 10-32 & 10-24



GWR-2162D **\$32⁹⁵**



Electrical Wire Cutter, Stripper, Crimper and Bolt Cutter

- Non-insulated: 7 & 8mm and 22-20 to 22-10
- Insulated: 22-20 to 12-10
- Cuts bolts in sizes: 4-40, 5-40, 6-32, 8-32, 10-32 and 10-24



TIT-11476 **\$59⁹⁵**

3-Pc Compact Electrical Tool Set

- 5.5" long pliers
- Cutting capacity: 30-10 AWG
- Stripping capacity: 22-10 AWG
- Crimping capacity: insulated terminals 22-10AWG



CNL-908 **\$38³⁵**

8.25" Wire Stripper/Cutter/Crimper

- Crimps insulated and non-insulated wire
- Cuts AWG 10-22
- Cuts bolt sizes: 10-24, 6-32, 8-32, 10-32, 4-40
- Crimps coax cable
- Crimps 7-8mm ignition terminals



CNL-957 **\$37⁵⁵**

7" Wire Stripper/Cutter

- Strips 10-20 AWG



CNL-968 **\$80¹⁵**

7.5" XLT™ Forged Wire Stripper/Cutter

- Xtreme Leverage Technology (XLT™)
- Ream and deburr up to 1" conduit
- Strips 8-18 AWG solid; 10-20 AWG stranded wire
- Cuts 6-32 and 8-32 bolts



Wire Stripping-Cutting-Crimping Pliers



OTC-5950D **\$72⁸⁵**
8" Long Angled Wire Stripper/Cutter
 • AWG20 to AWG12



Made in Germany

KNI-13 72 8 **\$108⁰⁵**
8" Forged Wire Stripper /Cutter

- Reaming head
- Cuts 6-32 and 8-32 screws
- Sheer-type cutter cuts 1/2" cable, fine-stranded
- Strips 10-20 AWG solid and stranded wire



MLW-48-22-3079 **\$43³⁵**
6-in-1 Combination Wire Plier

- Wire stripper: strips 8-18 AWG (solid wire); 10-20 AWG (stranded wire)
- Reaming head design smooths edges of metal pipe from 1/2" to 1"
- Bolt cutter: thread and cut #6 and #8 bolts
- Curved cutting blade for clean cuts through larger wire sizes



SGT-18950 **\$35⁷⁵**
Heavy Duty Automatic Wire Stripper

- Strips, crimps and cuts
- Automatically self-adjusts to strip solid or stranded 10-26 gauge wires



TIT-11475 **\$43⁶⁵**
Self Adjusting Wire Stripper

- For 10-24 AWG wires
- Built-in wire cutter
- Crimps 10-22 AWG insulated, 10-22 AWG non-insulated and 7-9mm ignition terminals



KLE-11063W **\$60⁸⁵**
6.5" Katapult® Solid & Stranded Wire Stripper/Cutter

- Strips and cuts: 8-20 AWG solid; 10-22 AWG stranded
- Compound action stripping: grip and strip via single-action squeezing motion
- Removes up to 1" long insulation jacket layer in a single step



KLE-11061 **\$50⁵⁵**
8-1/4" Self-Adjusting Wire Stripper/Cutter

- Strips and cuts: 10-20 AWG Solid; 12-22 AWG Stranded; 12/2 and 14/2 Romex® wire
- Adjustable stopper to control the length of the core strip
- Tensioning thumb wheel allows for precise stripping of smaller gauge wire



TIT-11980 **\$141¹⁵**
Hydraulic Cable Crimper

- 5-ton capacity
- Includes 9 dies
- Crimps aluminum and copper, AWG 12 to 2/0



TIT-11981 **\$163⁴⁵**
High Capacity Hydraulic Cable Crimper

- 70 kN (15,736 Lbf) capacity
- Includes 8 dies
- Aluminum: AWG 4-3/0 (25-95mm²)
- Copper: AWG 6-4/0 (10-120mm²)



IMP-IE150 **\$183⁸⁵**
Open & Closed Barrel Crimper

- Crimps insulated and non-insulated open & closed barrel and flag terminals, 10-22 AWG
- Screw sizing and cutting stations



SGT-18610 **\$67⁶⁵**
Open Barrel Crimping Tool

- Crimps 10-26 AWG non-insulated terminals
- Forms "B" crimp



SGT-18600 **\$48⁷⁵**

Open Barrel Crimping Tool

- Crimps most open barrel terminals such as Deutsch, computer sensor and Weather Pack
- Handles wire sizes 14-24 AWG



Terminal Crimpers for Deutsch Closed Barrel Terminals



Item #	Gauge	Contact Size	
SGT-18880	14, 16, 18	16	\$70.85
SGT-18890	20 & 22	20	\$68.95

SGT-18900 **\$55⁹⁵**
Professional Ratcheting Terminal Crimper

- Crimps 22-10 AWG insulated terminals



Wire Stripping-Cutting-Crimping Pliers

IMP-IE187 **\$113¹⁵**

Compact Head Five-Station Micro Terminal Crimper

- Crimps insulated and non-insulated open barrel and Weather Pack terminals, 14 to 24 AWG
- Works with GM micro terminals



TOOL AID
PROFESSIONAL AUTOMOTIVE TOOLS

SGT-18915 **\$52¹⁵**

Terminal Crimper for Weather Pack & Metri Pack Terminals

- Crimps 12-22 AWG open barrel Weather Pack, Metri Pack and Molex terminals
- Has 4 wire crimping and 2 seal crimping positions



SGT-18930 **\$77⁶⁵**

Ratcheting Terminal Crimper for Weather Pack Terminals & Other Open Barrel Terminals

- For most Weather Pack terminals and non-insulated open barrel connectors 10-22 AWG



SGT-18960 **\$215⁴⁵**

Ratcheting Terminal Crimping Kit with 7 Dies

- Includes 7 die sets for the most popular automotive terminals crimping applications



SGT-18920 **\$195⁶⁵**

Ratcheting Terminal Crimping Kit with 5 Dies

- Versatile kit includes 5 die sets that quickly interchange for a wide range of applications



Astro

AST-9478 **\$196⁴⁵**

220-Pc Weather Pack Interchangeable Ratcheting Crimping Tool & Accessory Set

- For assembling and crimping a wide range of the most common Delphi Weather Pack Connectors
- Specialized terminal release tool for disassembling packs



TOOL AID
PROFESSIONAL AUTOMOTIVE TOOLS

SGT-18870 **\$540⁹⁵**

18" Terminal Crimper for Deutsch Closed Barrel Terminals

- 6, 8 & 10 AWG



SGT-18840 **\$256⁹⁵**

26" Terminal Crimper with Rotating Die Set

- Crimps popular 8 - 4/0 AWG copper electrical and battery terminals using stranded copper wire



SGT-18650 **\$249¹⁵**

6-Pc Deutsch Terminals Service Kit

- Crimps both open barrel and closed barrel terminals
- Release tools for three applications: 14-16, 16-18 and 20-24 AWG wire



SGT-18700 **\$370³⁵**

11-Pc Master Terminals Service Kit

To crimp and release:

- Deutsch and other open and closed barrel terminals
- Weather Pack, Metri Pack, Molex terminals



OTC

CrimPro™ Wire Service Pliers

- Compact 7" design
- Gripping nose to pull, twist, bend, and shape
- Crimps 12-20 AWG insulated and non-insulated wire
- Strips 12-20 AWG wire
- Cutter make cuts below pivot



5950S



5950A

Item #	Tip	
OTC-5950S	Straight	\$45.45
OTC-5950A	Angled	\$64.75

IMP-IE145 **\$73⁸⁵**

Ignition Crimping Tool

- Insulated: 10-18 AWG terminals
- Non-insulated: 7-8mm Auto, W & F terminals
- Stripping stations for 7-8mm and 10-18 AWG
- Anvil-type cutter



Lineman's / Electrician's Pliers



KLE-D213-9NE **\$68²⁵**

9" Lineman's Side-Cutting Pliers

- Application: #8 AWG copper, aluminum and other soft metals
- Jaw capacity: 1.375" (3.5 cm)



KLE-D2000-9NE **\$84⁴⁵**

9" High-Leverage Heavy-Duty Cutting Lineman's Pliers

- Application: ACSR, screws, nails, most hardened wire
- Jaw capacity: 1.375" (3.5 cm)
- The 2000 series blades are designed for heavy-duty cutting



KLE-J213-9NE **\$82⁵⁵**

9.5" Journeyman™ Lineman's Side-Cutting Pliers

- Application: General purpose
- Jaw capacity: 1.375" (3.5 cm)
- Dual-material, comfort grip handles



MLW-48-22-6502 **\$40⁹⁵**

9" Long High Leverage Lineman's Pliers

- Cuts #2 ACSR



9" Long High Leverage Lineman's Pliers

- Cuts #2 ACSR
- Crimps insulated and non-insulated terminals
- Fish tape puller

Item #	Handle	
MLW-48-22-6100	Cushion Grip	\$37.45
MLW-48-22-6500	Dipped Handles	\$44.05



MLW-48-22-6503 **\$59³⁵**

9" Long High Leverage Lineman's Pliers with Thread Cleaner

- Cuts #2 ACSR
- Crimps insulated and non-insulated terminals
- A hinged opening on the pliers allows you to hold and clean 5/8" (16mm) pole line, bolts and threaded rod
- Fish tape puller



Lineman's Pliers with Wire Cutter & Crimper

- Reaming edges for deburring pipes
- Fish tape channel for flat steel fish tapes

Item #	Length	Cut Capacity	
GWR-82180C-06	8"	AWG5	\$38.35
GWR-82181C-06	9"	AWG6	\$43.05



GWR-82182C-06 **\$36⁰⁵**

8" Universal Pliers with Wire Cutter & Crimper

- Cut capacity: AWG6
- Bolt grip zone for turning nuts and fasteners



XLT™ Round Nose Lineman's Pliers



Item #	Length	
CNL-367	7.5"	\$55.45
CNL-368	8.5"	\$55.85
CNL-369	9.5"	\$57.75



WISE-GRIP® Lineman's Pliers with Cutting Edge

Item #	Model #	Length	
VIS-2078208	LP8®	8"	\$24.45
VIS-2078209	LP9®	9.5"	\$28.35



KNI-9K 00 80 158 US **\$263⁶⁵**

3-Pc Electrical Pliers Set

- 9 1/2" Lineman's pliers
- 8" Forged wire stripper
- 10" High leverage diagonal cutters

Hose Clamp Pliers

KNI-10 99 I220 **\$52¹⁵**

8-3/4" Ear Clamp Pliers with Additional Side Jaw

- For mounting 1-ear and 2-ear clamps (Oetiker system or similar)
- Versatile use for clamps on CV boots, cooler and fuel lines, air pressure systems, compressors
- Especially suitable for universal use thanks to the additional side jaw



CTA-4029 **\$40⁷⁵**
7" Long Clic® / Clic-R® Hose Clamp Pliers

- Securely locks and unlocks Clic® and Clic R® hose clamps

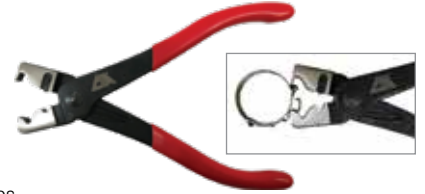

9CL-71180 **\$46⁸⁵**

Multi-Direction Hose Clamp Pliers

- For Audi and Volkswagen fuel lines, tank ventilation line clamps, and for general radiator hose clamps



LIS-17300 **\$126⁶⁵**

Flexible Hose Clamp Pliers

- 24" cable
- Expands hard-to-reach flat-band and Mobeax-type hose clamps found on radiator hoses, heater hoses and fuel lines



9CL-41172 **\$65³⁵**

13" Hose Clamp Pliers & Hose Remover

- Special pyramid-shaped tooth design efficiently grips hose clamps and helps remove melted rubber hoses near the engine



GWR-82115 **\$100²⁵**

Cable Hose Clamp Pliers

- Used to remove or install spring/flat band type hose clamps
- Can be used on clamps from 0" to 2" and from 1" to 3"



9CL-71280 **\$68¹⁵**

10" Hose Clamp Pliers with 35° Offset

- Pliers access limited spaces easily
- Special crossing grooves enable pliers to work from different directions



GEARWRENCH

GWR-3976D **\$42⁹⁵**

Straight Hose Clamp Pliers

- For use on flat band hose clamps



OTC-4502 **\$52⁴⁵**

2-Pc Hose Clamp Pliers Set

- Services most ring-type or flat-band hose clamps
- Ratchet locking mechanism
- Jaws swivel to access hose clamps in any position



MAY-28680 **\$163⁶⁵**

Professional Hose Clamp Pliers with Long Flexible Cable

OTC-4525 **\$94⁵⁵**
Flexible Hose Clamp Pliers

- Heavy duty 24" cable
- Allow access to flat-type hose clamps

AST-94093 **\$107⁸⁵** **Astro**

Multi-Cable Hose Clamp Pliers

- Features 3 cables and 4 different jaw types and sizes for use on most automotive tension hose clamps
- Includes standard, extra large, small and Clic-R® clamp jaws



AST-9409A **\$63⁹⁵**

Hose Clamp Pliers

- Allows for removal of plastic and/or metal self-tightening hose clamps with diameters of 11/16" - 2-1/2" (18mm - 54mm)



LIS-55230 **\$25³⁵**

Clic® & Clic-R® Hose Clamp Pliers

- Double-sided tool removes and installs Clic® and Clic-R® hose clamps without damaging the clamps

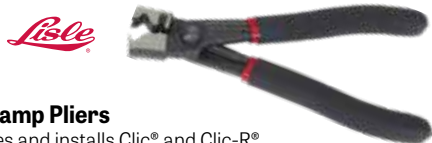

Hose Clamp Pliers



CTA-1224 **\$84¹⁵**

10.5" Long Locking Hose Clamp Pliers with Special Offset Angle Jaws

- Multi-directional slotted pattern for wide application range, including: tank ventilation line clamps, radiator hose clamps, transmission cooler lines and more
- Opens up to 2.5" (65mm)



SLY-16200 **\$67⁹⁵**

Mobeia Hose Clamp Lock Set

- Three sizes to fit most clamp styles
- These hose clamp locks keep the clamp loaded, freeing up pliers for the next clamp



Hose Pinching Pliers



LIS-22850 **\$10¹⁵**
2-Pc Hose Pinchers



Hose Pinch Off Pliers

Item #	Hose Size	Length	
LIS-67500	3/4"	5.5"	\$25.95
LIS-67600	1-1/4"	9.25"	\$50.75



GWR-145 **\$37²⁵**
10" Hose Pinch Off Pliers
• Automatic locking ratchet



Self Locking Hose Pinching Pliers

- Small: up to 3/4" (#1460)
- Medium: up to 1-1/4" (#1470)
- Large: up to 2-1/2" (#1480)



Item #	Hose Size	
LAN-1500	3-Pc Set: 3/4", 1-1/4", 2-1/2"	\$132.85
LAN-1460	3/4"	\$31.65
LAN-1470	1-1/4"	\$39.65
LAN-1480	2-1/2"	\$63.45



ATD-5465 **\$134⁷⁵**
3-Pc Hose Pinch Off Pliers Set

- 8", 10", 12"
- Cocking ratchet mechanism with heavy duty swivel jaws



3-Pc Hose Pinching Pliers Set

- Small: up to 3/8" (10mm)
- Medium: up to 5/8" (15mm)
- Large: up to 1" (24mm)



Item #	Description	
TIT-51752	Straight	\$20.75
TIT-51769	90° Angle	\$28.95



MIT-MVA7609 **\$43⁵⁵**

Locking Hose Pinch Off Clamps

- 6" and 8" clamps for hoses up to 1-1/4" (32 mm) diameter



PBT-70717 **\$17²⁵**

Small Line Clamps (Twin Pack)

- Seals flexible brake and fuel lines
- Range: 1/8" (3mm) – 5/16" (8mm)

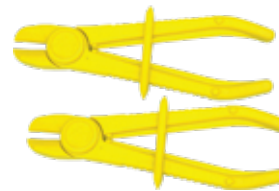

PBT-70730 **\$27⁶⁵**

Medium Line Clamp (Twin Pack)

- Seals heater hose, etc.
- Range: 1/2" (13mm) – 3/4" (19mm)

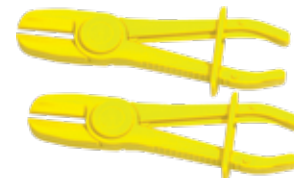

PLIERS

Hose Cutters

CAL-767 **\$38⁹⁵**

Ratcheting Tubing Cutter

- 1.5" diameter capacity
- Cuts hoses, PVC pipes, battery cables, copper cables and non metallic air brake hoses



SGT-14300 **\$43³⁵**



Mighty Cutter

- Cuts rubber or plastic hose, PVC pipe and certain types of wire and wire cable
- Handles up to 1-1/8" O.D. material



LIS-11420 **\$39⁷⁵**



Hose Cutter

- Cuts flexible hose up to 1-1/4"



ATD-906 **\$31⁷⁵**



Hose Cutter

- Capacity: 1-1/2" O.D.



RGD-23488 **\$27⁵⁵**

Plastic Pipe & Tubing Cutter

- Capacity: 1/8" - 1-5/8" O.D.
- Reversible blade

RGD-30088 **\$172⁸⁵**

Ratchet Action Plastic Pipe & Tubing Cutter

- Capacity: 1/8" - 2-3/8" O.D.

Hose Release Pliers

Ratchet Master.



Quick Release Pliers

Designed to remove many lines and valves, commonly:

- Push Lock connections & fittings
- PCV valves • Rubber lines on fuel filters
- Radiator water overflow lines
- Wiper assembly lines and more

Item #	Description	Fits Line Size	
RAT-QRPLA	Large Angle	3/8" to 5/8" (12mm to 16mm)	\$66.85
RAT-QRPSA	Small Angle	1/8" to 3/8" (3mm to 13mm)	\$66.85
RAT-QRPLV	Large Vertical	3/8" to 3/4" (12mm to 23mm)	\$66.85
RAT-QRPSV	Small Vertical	1/8" to 3/8" (3mm to 13mm)	\$66.85
RAT-QRP4S	4-Piece Set	All sizes above	\$262.95

Hose Grip Pliers

TITAN

TIT-60776 **\$44³⁵**

3-Pc 11" Long Hose Grip Pliers Set

- Serrated jaw
- Small, medium and large



SUNEX[®] TOOLS

SUN-3703V **\$81⁵⁵**

3-Pc 11" Long Hose Grip Pliers Set

- 5/16", 1/2", 3/4"

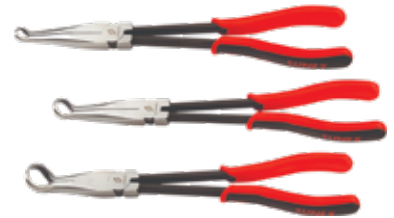

ATD-813 **\$90⁶⁵**

3-Pc 11" Long Ring Nose Pliers Set

- 5/16", 1/2", 3/4"



CV Boot Clamp Pliers



LIS-30600 **\$51⁵⁵**

Offset Boot Clamp Pliers

- Crimps ear-type clamps in hard-to-reach areas



LIS-30800 **\$54⁵⁵**

CV Boot Clamp Pliers

- For all ear-type clamps including GM FWD outboard CV joints

Welding Pliers

IRWIN VISE-GRIP



VIS-1873303 **\$39²⁵**

8" MIG Welding Pliers

- Specially-designed nose removes welding spatter
- Multiple jaws for drawing out wire and removing of installing tips and nozzles



Retaining Ring & Snap Ring Pliers

LANG  Made in USA

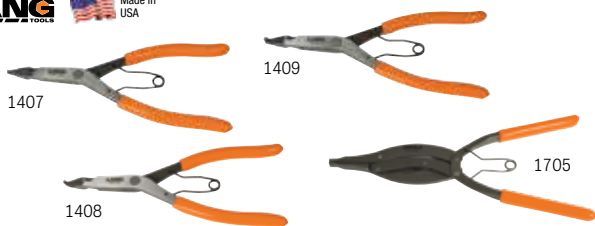

Locking Ring Pliers

- Spreads, removes and installs lock rings without holes

Item #	Description	
LAN-1407	9" Long – Straight Tip	\$46.15
LAN-1408	9" Long – Bent Tip	\$52.15
LAN-1409	9" Long – Right Angle Tip	\$51.05
LAN-1705	10" Long – Parallel Jaws	\$88.45

VIM

2-Pc Internal/External Snap Ring Pliers Set

- 1.8mm tips

Item #	Tip	
VIM-SR7	Straight	\$87.95
VIM-SRB7	Bent	\$87.95

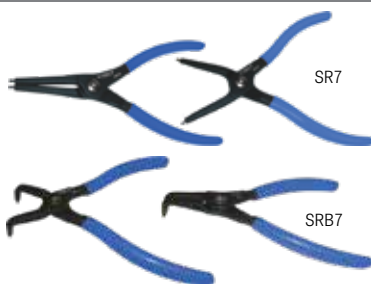

GW GEARWRENCH

GWR-3151 \$57²⁵ Universal Convertible Retaining Ring Pliers

- For up to 2" diameter rings



CNL-927 \$56⁵⁵ 8" Retaining Ring Pliers

- External: 1/4" to 2"
- Internal: 3/8" to 2"
- Straight tips: 0.039", 0.047", 0.074"
- 90° tips: 0.039", 0.047"

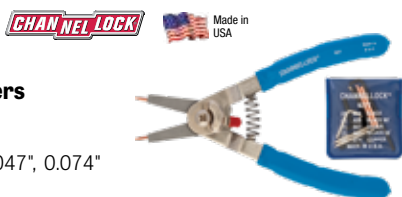

CNL-927T \$15²⁵ Universal Retaining Ring Tip Kit

- Straight tips: 2 x 0.039", 2 x 0.047", 2 x 0.074"
- 90° tips: 2 x 0.039", 2 x 0.047"



SUNEX
TOOLS

SUN-3614V \$101²⁵ 4-Pc 7" Snap Ring Pliers Set

- Internal: straight and bent nose
- External: straight and bent nose

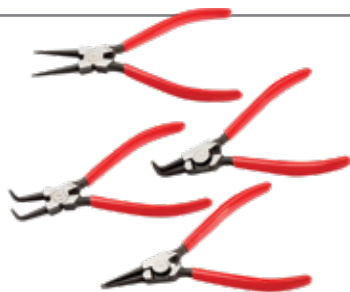

Astro

AST-9401 \$69⁰⁵ 10-Pc Internal/External Snap Ring Pliers Set

- 90° tip pliers: .038", .047", .070", .090"
- Straight tip pliers: .038", .047", .070", .090"
- (1) 5" hook tool; (1) 5" pick tool



OTC

OTC-4512 \$158⁹⁵ Internal/External Snap Ring Pliers Set

- Straight tip pliers: 0.090", 0.070", 0.047", 0.038"
- 90° tip pliers: 0.090", 0.070", 0.047", 0.038"
- Picks: straight tip and 90° tip



PLATINUM TECH  Made in USA

ATD-PLT99915 \$255¹⁵ 12-Pc Combination Internal/External Snap Ring Pliers Set

- Straight tip pliers: .038", .047", .070", .090"
- 45° tip pliers: .038", .047", .070", .090"
- 90° tip pliers: .038", .047", .070", .090"



PLATINUM TECH  Made in USA

ATD-PLT99913 \$149³⁵ 6-Pc Combination Internal/External Snap Ring Pliers Set

- Straight tip pliers: .038", .047", .070"
- 90° tip pliers: .038", .047", .070"



LANG  Made in USA

LAN-3495 \$217⁸⁵ 12-Pc Combination Internal/External Snap Ring Pliers Set

- Internal: 3/8" - 3" (10-76mm)
- External: 1/8" - 3-1/2" (3-89mm)



LANG  Made in USA

LAN-3595 \$297⁵⁵ 12-Pc Quick Switch Internal/External Snap Ring Pliers Set

- Internal: 3/8" - 3" (10-76mm)
- External: 1/8" - 3-1/2" (3-89mm)



Retaining Ring & Snap Ring Pliers

LANG  Made in USA

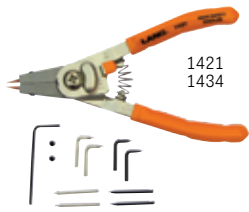

Quick Switch Snap Ring Pliers with Adjustable Stop and Tip Kit

Item #	Internal	External	
LAN-1421	1/4" to 1"	1/8" to 1"	\$41.75
LAN-1434	3/8" to 2"	1/4" to 2"	\$47.35
LAN-75	1-13/16" to 4"	1-1/2" to 4"	\$100.15
LAN-1450	2-Piece Set Includes #1421 & #1434		\$108.95
LAN-1465	3-Piece Set Includes #1421, #1434 and #75		\$205.55

GW GEARWRENCH

GWR-82110 **\$128⁵⁵** 2-Pc Double-X™ Internal/External Snap Ring Plier Set



LANG  Made in USA

Heavy Duty Snap Ring Pliers

- Spring ratchet locking mechanism securely holds against snap ring tension
- Straight 0.120" tip



Item #	Description / Size Range	
LAN-1485	INTERNAL Snap Ring Pliers 3-1/16" - 6-1/4" (78mm - 159mm)	\$131.85
LAN-1486	EXTERNAL Snap Ring Pliers 3-1/2" - 6-1/2" (89mm - 165mm)	\$131.85
LAN-1487	2-Piece Set Includes #1485 & #1486	\$250.55

Astro

AST-9402 **\$76⁰⁵**

2-Pc 16" Long Internal/External Snap Ring Pliers Set

- Includes 0°, 45°, and 90° tip sets



KNIPEX  Made in Germany

KNI-00 20 03 SB **\$191³⁵**

4-Pc Precision Snap Ring Pliers Set

- Straight tips: 15/32" to 2-23/64"

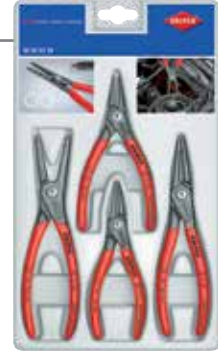

KNI-00 20 04 SB **\$402⁷⁵**

8-Pc Precision Snap Ring Pliers Set

- Straight tips: 15/32" to 2-23/64"
- Bent tips: 15/32" to 2-23/64"



Lisle

LIS-38700 **\$71⁰⁵**

Spindle Snap Ring Pliers for Ford Super Duty

- Replaces the spindle snap rings found on 2007 and newer Ford
- Fits into the 2-1/2" inside diameter of the hub
- Ratcheting lock mechanism



LANG  Made in USA

LAN-1489 **\$94⁹⁵** 26" Long Large Internal Snap Ring Pliers

- Used on GM 5L40, 5L50, 6L45, 6L50, 6L80 and 6L90 and some BMW transmissions to remove large internal snap ring



LAN-87 **\$173⁷⁵** Heavy-Duty Snap Ring Pliers with Tip Kit

- Provides safe and stable service of extra large retaining rings
- Internal: 3-1/2" - 7" (90mm - 175mm)
- External: 3-1/2" - 7" (90mm - 175mm)



Locking Pliers

Milwaukee

MLW-48-22-3690 **\$151²⁵**

While Qty. Last

10-Pc Torque Lock™ Locking Pliers Kit

- TORQUE LOCK™ and MAXBITE™ features provide faster tool setup maximized pressure points
- Contains curved jaw, straight jaw, long nose pliers and C-clamp locking pliers with regular jaws
- Limited lifetime warranty



IRWIN VISE-GRIP

VIS-1078TRAY **\$225²⁵**

10-Pc Original Locking Pliers Tray Set

- Contains: 10R®, 10CR®, 7R®, 7WR®, 7CR®, 5WR®, 6LN®, 9LN®, 6R® & 11R®



IRWIN VISE-GRIP

VIS-641 **\$140⁶⁵**

6-Pc Original Locking Pliers Kitbag with 6 Koozie Cups Set

- Contains: 10WR®, 9LN®, 7R®, 6LN®, 5CR® & 4WR®



IRWIN VISE-GRIP

VIS-68 **\$113²⁵**

5-Pc Original Locking Pliers Kitbag Set

- Contains: 10R®, 10CR®, 7WR®, 6LN®, & 5CR®



IRWIN VISE-GRIP

VIS-71 **\$90⁴⁵**

4-Pc Original Locking Pliers Kitbag Set

- Contains: 10CR®, 7R®, 6LN® & 5WR®



Straight Jaw Locking Pliers

Item #	Length	
MLW-48-22-3507	7"	\$18.35
MLW-48-22-3510	10"	\$19.65



Curved Jaw Locking Pliers

Item #	Length	
MLW-48-22-3610	10"	\$20.65



Locking Pliers with Grip

Item #	Length	
MLW-48-22-3410	10"	\$18.35



Long Nose Locking Pliers

Item #	Length	
MLW-48-22-3506	6"	\$18.45



Locking C-Clamps

Item #	Length	
MLW-48-22-3531	11"	\$29.95



Locking C-Clamps

Item #	Length	
MLW-48-22-3522	6"	\$20.35
MLW-48-22-3521	11"	\$31.75



Locking Chain Wrench

Item #	Length	
MLW-48-22-3542	9"	\$36.95



Straight Jaw Locking Pliers

Item #	Length	Cap.	
ECL-E10R	10"	1-3/4"	\$16.95



Curved Jaw Locking Pliers

Item #	Length	Cap.	
ECL-E10CR	10"	1-7/8"	\$19.15



Curved Jaw Locking Pliers with Wire Cutters

Item #	Length	Cap.	
ECL-E10WR	10"	1-7/8"	\$19.35



Locking C-Clamps, Regular Tips

Item #	Length	Cap.	
ECL-E11R	11"	3-1/8"	\$29.35



U-Jaw Locking Welding Clamp

Item #	Length	Cap.	
ECL-E9R	9"	1-3/4"	\$22.35



Locking Pliers

**IRWIN
VISE-GRIP®**

**VISE-GRIP®
Curved Jaw Locking
Pliers with Wire Cutter**



Item #	Model #	Length	Jaw Capacity	
VIS-1002L3	4WR®	4"	1"	\$19.55
VIS-902L3	5WR®	5"	1-1/8"	\$21.75
VIS-702L3	7WR®	7"	1-1/2"	\$22.35
VIS-502L3	10WR®	10"	1-7/8"	\$22.75

**VISE-GRIP®
Curved Jaw
Locking Pliers**



Item #	Model #	Length	Jaw Capacity	
VIS-4935578	7CR®	7"	1-1/2"	\$22.35
VIS-4935576	10CR®	10"	1-7/8"	\$22.75

**VISE-GRIP®
Straight Jaw
Locking Pliers**



Item #	Model #	Length	Jaw Capacity	
VIS-302L3	7R®	7"	1-1/2"	\$22.35
VIS-102L3	10R®	10"	1-7/8"	\$22.75

**VISE-GRIP®
Long Nose
Locking Pliers**



Item #	Model #	Length	Jaw Capacity	
VIS-1602L3	4LN®	4"	1-5/8"	\$22.15
VIS-1402L3	6LN®	6"	2"	\$23.55
VIS-1502L3	9LN®	9"	2-3/4"	\$28.15

**VISE-GRIP®
Large Jaw
Locking Pliers**



Item #	Model #	Length	Jaw Capacity	
VIS-12L3	12LC®	12"	3-1/8"	\$34.45

**IRWIN
VISE-GRIP®**

**VISE-GRIP®
Locking C-Clamps
with Regular Tips**



Item #	Model #	Length	Jaw Capacity	
VIS-17	6R®	6"	2-1/8"	\$20.95
VIS-19	11R®	11"	4"	\$35.35
VIS-21	18R®	18"	8"	\$51.75
VIS-275	24R®	24"	10"	\$63.75

**VISE-GRIP®
Locking C-Clamps
with Swivel Pads**



Item #	Model #	Length	Jaw Capacity	
VIS-18	6SP®	6"	2-1/8"	\$23.55
VIS-20	11SP®	11"	4"	\$37.95
VIS-22	18SP®	18"	8"	\$53.15
VIS-28	24SP®	24"	10"	\$66.35

**VISE-GRIP®
Locking
Chain Clamp**



Item #	Model #	Length	Jaw Capacity	
VIS-27ZR	20R®	9"	18"	\$50.15

**VISE-GRIP®
Locking
Welding Clamp**



Item #	Model #	Length	Jaw Capacity	
VIS-25ZR	9R®	9"	2-3/4"	\$39.55

**VISE-GRIP®
Locking
Sheet Metal Tool**



Item #	Model #	Length	Jaw Capacity	
VIS-23	8R®	8"	3-1/8"	\$33.15

Ball Pein Hammers



Ball Pein Hammers with Fiberglass Handles

- Meets or exceeds ANSI specs

Item #	Head Weight	
ATD-4035	5-Pc Set: 8, 12, 16, 24, 32 oz	\$164.25
ATD-4038	16 oz	\$32.35
ATD-4039	24 oz	\$45.55
ATD-4040	32 oz	\$56.35



Ball Pein Hammers

- Fiberglass handles with cushion grip

Item #	Weight	Overall Length	Face Diameter	
WLM-JHW20542	8 oz	10-3/4"	7/8"	\$16.65
WLM-JHW20543	12 oz	11-3/4"	7/8"	\$19.25
WLM-JHW20544	16 oz	13"	1-7/8"	\$22.55
WLM-JHW20545	24 oz	15"	1-1/4"	\$25.35
WLM-JHW20546	32 oz	15"	1-1/4"	\$28.25



B.A.S.H.[®] Ball Pein Hammers

Item #	Head Weight	Handle Length	Face Diameter	
WIL-32414	1.5 lbs (24 oz)	14"	1-1/2"	\$82.75
WIL-33214	2 lbs (32 oz)	14"	1-3/4"	\$93.95
WIL-34014	2.5 lbs (40 oz)	14"	1-7/8"	\$105.15



WIL-11110 **\$224⁴⁵**

3-Pc B.A.S.H.[®] Ball Pein Hammer Kit

- 1-1/2 lb head, 1-1/2" face diam.
- 2 lb head, 1-3/4" face diam.
- 2-1/2 lb head, 1-7/8" face diam.
- 14" handles



Sledge Hammers



Sledge Hammers

- Fiberglass handles

Item #	Weight	Overall Length	Face Diameter	
WLM-JHWSHF-4A	4 lbs	14"	1-5/8"	\$72.95
WLM-JHWSHF-6A	6 lbs	32"	1-3/4"	\$90.05
WLM-JHWSHF-8A	8 lbs	32"	2"	\$103.95
WLM-JHWSHF-10LA	10 lbs	32"	2-1/8"	\$131.15
WLM-JHWSHF-12A	12 lbs	32"	2-1/4"	\$143.85
WLM-JHWSHF-16LA	16 lbs	32"	2-5/8"	\$181.05
WLM-JHWSHF-20A	20 lbs	32"	2-3/4"	\$212.55



B.A.S.H.[®] Sledge Hammers

Item #	Head Weight	Handle Length	Face Diameter	
WIL-20416	4 lbs	16"	1-3/4"	\$123.05
WIL-20624	6 lbs	24"	1-7/8"	\$167.75
WIL-20636	6 lbs	36"	1-7/8"	\$187.85
WIL-20836	8 lbs	36"	2-1/8"	\$209.35
WIL-21036	10 lbs	36"	2-1/4"	\$241.75
WIL-21236	12 lbs	36"	2-1/4"	\$271.95
WIL-21436	14 lbs	36"	2-3/8"	\$295.65
WIL-22036	20 lbs	36"	2-3/4"	\$403.25

Double Face Sledge Hammers with 30" Long Indestructible Handles

Item #	Head Weight	
OTC-5790ID-830	8 lbs	\$222.05
OTC-5790ID-1030	10 lbs	\$235.55
OTC-5790ID-1230	12 lbs	\$253.45
OTC-5790ID-1430	14 lbs	\$255.35



Sledge Hammers with 16" Indestructible Handle

Item #	Head Weight	
ATD-4076	6 lbs	\$181.25
ATD-4079	8 lbs	\$177.75



Rubber Mallets

Rubber Mallets

Item #	Size	
TIT-63217	16 oz	\$14.35
TIT-63232	32 oz	\$20.25



Dead Blow Hammers



B.A.S.H.[®] Dead Blow Hammers



Item #	Head Weight	Handle Length	Face Diameter	
WIL-55114	1.5 lbs	14"	1-1/2"	\$82.75
WIL-55214	2 lbs	14"	1-3/4"	\$91.65
WIL-55314	3 lbs	14"	1-7/8"	\$102.85
WIL-55416	4 lbs	16"	2-1/4"	\$143.15
WIL-55830	8 lbs	30"	2-5/8"	\$198.55
WIL-11113	3-Pc Kit: 2 lb, 3 lb, 4 lb			\$265.45

Dead Blow Hammers

Item #	Head Weight	
MLW-48-22-9150	28 oz	\$43.75
MLW-48-22-9151	48 oz	\$56.65



Dead Blow Ball Pein Hammers

Item #	Head Weight	
MLW-48-22-9140	16 oz	\$67.05
MLW-48-22-9141	32 oz	\$92.85



Dead Blow Hammers

Item #	Head Weight	
TIT-63008	8 oz	\$14.25
TIT-63116	16 oz	\$16.75
TIT-63124	24 oz	\$20.05
TIT-63032	32 oz	\$22.95



TITAN

TIT-63143 **\$62⁸⁵**
3-Pc Double-Faced Dead Blow Hammer Set
 • 16 oz (1 Lb), 32 oz (2 Lb), 48 oz (3 Lb)



TITAN

TIT-63133 **\$61²⁵**
3-Pc Dead Blow Hammer Set
 • 12 oz. brass hammer
 • 1 lb ball-pein hammer
 • 1/2 lb dead blow hammer



ATD-4082 **\$77¹⁵**
3-Pc Dead Blow Hammer Set
 • Includes: 1/2 lb, 1 lb and 2 lbs



Dead Blow Hammers

• Non-marring polyurethane head



Item #	Weight	
GWR-82240	18 oz	\$38.25
GWR-82242	33 oz	\$53.55
GWR-82244	54 oz	\$68.85



Dead Blow Hammers

Item #	Head Weight	Overall Length	
GWR-69-550G	5.5 lbs	20"	\$168.35
GWR-69-551G	9 lbs	30"	\$192.95
GWR-69-552G	10.5 lbs	30"	\$271.35
GWR-69-554G	12 lbs	36"	\$301.55



Drilling Hammers



GWR-82255 **\$33⁶⁵**
3 Lb (48 oz) Drilling Hammer with Fiberglass Handle



WLM-JHW20678 **\$26³⁵**
2 Lb (32 oz) Drilling Hammer

• Fiberglass handle with cushion grip
 • Overall length: 10-1/4"



WIL-20212 **\$93⁹⁵**
B.A.S.H.[®] Drilling/Sledge Hammer

• Head weight: 2-1/2 lb
 • Face diameter: 1-1/2"
 • Handle length: 12"



Club/Hand Drill Hammers with Indestructible Handles



Item #	Head Weight	Handle Length	
OTC-5791ID-412	4 lbs	12"	\$110.75
OTC-5791ID-416	4 lbs	16"	\$118.45

Mixed Hammer Sets



ATD-14033 **\$253¹⁵**
3-Pc B.A.M. Indestructible Hammer Set

- Ball pein: 32 oz. head, 14" handle
- Cross pein: 2.5 lb head, 16" handle
- Sledge: 4 lb head, 12" handle



ATD-4045 **\$215⁶⁵**
5-Pc Hammer Set

- 16 oz and 32 oz ball pein hammers
- 3 lb sledge hammer
- 3 lb cross pein hammer
- 32 oz rubber mallet



TIT-63136 **\$149⁵⁵**
6-Pc General Hammer Set

- 3 lb cross pein hammer
- 3 lb sledge hammer
- 32 oz. rubber mallet
- 16 oz. and 32 oz. ball pein hammers
- 32 oz. dead blow hammer



TIT-63125 **\$117⁷⁵**
5-Pc Hammer Set

- 16 oz. ball pein hammer
- 32 oz. ball pein hammer
- 32 oz. rubber mallet
- 3 lb sledge hammer
- 3 lb cross pein hammer
- Comfortable, textured handles



WIL-11111 **\$224⁴⁵**
3-Pc B.A.S.H.[®] Mechanics Hammer Kit

- Sledge: 4 lb head, 12" handle
- Ball pein: 2 lb head, 14" handle
- Cross pein: 2 lb head, 16" handle



WIL-11109 **\$445⁵⁵**
6-Pc Master B.A.S.H.[®] Hammer Kit

- (2) Sledge: 2-1/2 lb and 4 lb heads, 12" handles
- (2) Dead blow : 1-1/2 lb and 2 lb heads, 14" handles
- (1) Cross pein: 24 oz. head, 16" handle
- (1) Ball pein: 24 oz. head, 14" handle



GWR-82303D **\$137⁷⁵**
5-Pc Hammer and Mallet Set

- 16 oz. ball pein hammer
- 3 lb. drilling hammer
- 16 oz. rubber mallet with hickory handle
- 12 oz. soft face hammer
- 16 oz. dead blow hammer



Cross Pein Hammers

WLM-JHW20651 **\$30⁴⁵**

- Cross Pein Hammer**
- Fiberglass handle with cushion grip handle
 - Weight: 40 oz
 - Overall length: 15-3/4"



TIT-63004 **\$35⁹⁵**
3 lb. Cross Pein Hammer



WIL-30316 **\$114⁰⁵**

- B.A.S.H.[®] Cross Pein Hammer**
- Head weight: 3 lb
 - Face diameter: 1-3/4"
 - Handle length: 16"



Non-Sparking Brass Hammers

ATD-4069 **\$253²⁵**
Cushion Grip Brass Hammer with Fiberglass Handle

- Head weight: 5 lbs



Brass Non-Sparking Hammers

Item #	Size	
TIT-63216	2 lbs	\$78.25
TIT-63040	3 lbs	\$111.85



PRY BARS

Screwdriver Pry Bars



MAY-31092 **\$29¹⁵**

2-Pc 6" Long Mini Pry Bar Set

- Straight and curved tips



3-Pc 5" Long Mini Pocket Pry Bars

- 3/16" diameter steel blade
- Tips: 0°, 27°, 55°



Item #	Description	
LAN-853-06-3ST	Orange	\$40.55
LAN-853-06-3ST-B	Blue	\$40.55
LAN-853-06-3ST-G	Green	\$40.55



LIS-35100 **\$11³⁵** 5" Long Pocket Size Pry Bar with Strike Cap

- 1/4" shaft



MLW-48-22-9214 **\$72⁸⁵** 4-Pc Pry Bar Set

- 8", 12", 18", 24"
- Lifetime guarantee



MAY-14074 **\$279⁶⁵** 3-Pc Dominator® Pro Straight & Curved Pry Bar Set

- 18" straight pry bar
- 24" & 36" curved pry bars



14116, 14117, 14119, 14120, 14123



Dominator® Curved Screwdriver Pry Bars

- Capped end for striking

Item #	Length x Body	
MAY-60148	24" x 1/2"	\$68.05
MAY-14116	31" x 1/2"	\$89.25
MAY-14117	36" x 5/8"	\$128.85
MAY-14123	44" x 7/8"	\$252.25
MAY-14119	48" x 3/4"	\$192.85
MAY-14120	58" x 3/4"	\$207.75



3-Pc Dominator® Curved Screwdriver Pry Bar Sets

- 12", 17" and 25"
- Capped end for striking

Item #	Colour	
MAY-61355	Black/Red	\$141.35
MAY-14071BL	Blue/Black	\$166.15



MAY-61366 **\$239⁴⁵**

5-Pc Dominator Curved Screwdriver Pry Bar Set

- 8", 12", 17", 25" and 31"
- Capped end for striking



CNL-PRY-3C **\$87⁶⁵**

3-Pc Screwdriver Pry Bar Set

- 12", 17", 25" pry bars with curved tips
- Capped end for striking



SUN-9803 **\$87⁹⁵**

3-Pc Pry Bar Set

- 12", 17", 25"



SUN-9704 **\$43⁷⁵**

4-Pc Pry Bar Set

- 8", 12", 18", 24"



Pry Bars with Bent Tips

- Capped end for striking
- Lifetime warranty



Item #	Description	
LAN-853-3ST	3-Pc Set: 12", 17", 25"	\$93.15
LAN-853-5ST	5-Pc Set: 12", 17", 25", 31", 36"	\$180.95
LAN-853-6ST	6-Pc Set: 12", 17", 25", 31", 36", 45"	\$284.65
LAN-853-12	12" \$29.15	LAN-853-31 31" \$43.75
LAN-853-17	17" \$31.35	LAN-853-36 36" \$54.95
LAN-853-25	25" \$40.25	LAN-853-45 45" \$94.05



ATD-63905 **\$183¹⁵**

5-Pc Pry Bar Set

- Capped end for striking
- Steel shank extends the entire length of the handle
- 12", 17", 25", 31", 36"



Indexing Pry Bars



Indexing Pry Bars

Item #	Description/Length	Price
GWR-82300	2-Pc Non-Extendable: 8" & 16"	\$86.85
GWR-82301D	3-Pc Non-Extendable: 8", 10" & 16"	\$134.25
GWR-82210	Non-Extendable: 10"	\$47.35
GWR-82216	Non-Extendable: 16"	\$71.05
GWR-82224	Non-Extendable: 24"	\$94.75
GWR-82233	Non-Extendable: 33"	\$142.15
GWR-82220	Extendable: from 18" to 29"	\$157.95
GWR-82248	Extendable: from 29" to 48"	\$217.85



OTC-7177 **\$288⁴⁵** Heavy Duty Extendable Indexing Pry Bar

- Designed for heavy duty uses such as positioning/repositioning engines or equipment
- Extends from 34" to 53"
- 31 locking positions
- Optimal loading of 1500 lbs to 2200 lbs



OTC-7175 **\$174⁹⁵** 3-Pc Indexing Pry Bar Set

- 10", 12" and 15"
- Indexible to 180° for better access
- 14 locking positions



Jimmy / Line-Up Pry Bars



Jimmy Bars	Item #	Length	Diameter	Price
	OTC-7166	18"	5/8"	\$44.05
	OTC-7167	24"	3/4"	\$52.95
	OTC-7168	30"	7/8"	\$62.75
	OTC-7420	46"	7/8"	\$149.05



MAY-69151-TR **\$176⁹⁵**

3-Pc Jimmy Bar Set

- 1/2" x 15", 5/8" x 19", 3/4" x 25"



MAY-40024 **\$154⁷⁵**

60" Line-Up Pry Bar

- Long, tapered end for aligning and adjusting metal or wood
- Angled chisel end for extra leverage



MAY-61306 **\$118⁸⁵**

3-Pc Line-Up Pry Bar Set

- Line-up pry bars: 14" & 20"
- Rolling head pry bar: 16"

Rolling Head Pry Bars



MAY-60150 **\$191²⁵** 3-Pc Professional Rolling Head Pry Bar Set

- 1/2" x 12", 5/8" x 16", 3/4" x 21"



SUN-9804 **\$73⁴⁵** 4-Pc Rolling Head Pry Bar Set

- 6", 12", 16", 20"



PUNCHES & CHISELS

TIT-17100 **\$13¹⁵** **TITAN**
Automatic Center Punch
 • Adjustable spring tensioner



FOW-72-500-290-0 **\$30⁹⁵**
Heavy Duty Automatic Center Punch
 • Features adjustable compression for marking a variety of materials



LIS-30280 **\$26⁶⁵** **Lisle**
Automatic Center Punch



MAY-66000 **\$434⁶⁵** **MAYHEW TOOLS**
16-Pc Hollow Punch Set
 • 1/8" to 1-3/16"



LAN-950 **\$80⁰⁵** **LANG TOOL**
11-Pc Gasket Hole Punch Set
 • Cuts holes and internal radiuses in gaskets and other soft material
 • 1/4", 5/16", 3/8", 7/16", 1/2", 9/16", 5/8", 3/4", 7/8", 1"



MAYHEW TOOLS MAY-50301 **\$54³⁵**
Safety Punch & Chisel Holder
 • Up to 1" diameter



SGT-14270 **\$103²⁵** **TOOL AID**
3-Pc Brass Drift Pin Punch Set
 • 1/2" x 7", 5/8" x 7", 3/4" x 8"



SGT-14290 **\$76⁴⁵** **TOOL AID**
4-Pc Brass Pin Punch Set
 • 1/8" x 4", 3/16" x 4", 1/4" x 4", 3/8" x 6"



MAYHEW TOOLS MAY-61367 **\$98⁵⁵**
9-Pc Brass Pilot Punch Set
 • 1/16" to 3/8"



MAY-62277 **\$71⁷⁵** **MAYHEW TOOLS**
4-Pc Brass Punch Set
 • 3/8" drift punch
 • 1/4" & 3/8" pin punches
 • 1/4" solid punch



MAY-61360 **\$83²⁵** **MAYHEW TOOLS**
3-Pc Brass Drift Punch Set
 • 3/8" - 10mm
 • 1/2" - 13mm
 • 3/4" - 19mm



OTC-4602 **\$62⁶⁵** **OTC**
Non-Sparking Brass Punch Set
 • 8" punch (5/8" hex, tapered to 3/8")
 • 10" straight punch (3/4" diameter)



OTC-4629 **\$394³⁵** **OTC**
9-Pc Brass Hammer and Punch Set
 • (2) hammers: 24 oz. & 12 oz.
 • (2) tapered punches
 • (1) hex tapered punch
 • (2) drift punches
 • (2) pin punches



ATD PLATINUM TECH **Made in USA** ATD-PLT99800 **\$88⁶⁵**
5-Pc Long Taper Punch Set
 • Self-centering nose
 • 1/8", 5/32", 3/16", 7/32", 1/4"



ATD PLATINUM TECH **Made in USA** ATD-PLT99801 **\$55¹⁵**
6-Pc Precision Punch Set
 • (1) Center punch
 • (4) Pin punches: 1/16", 5/64", 3/32", 1/8"
 • (1) Solid punch: 3/32"



ATD-762 **\$28¹⁵** **ATD**
5-Pc Roll Pin Punch Set
 • 1/8", 5/32", 3/16", 1/4", 5/16"
 • Vinyl roll pouch included



ATD PLATINUM TECH **Made in USA** ATD-PLT99803 **\$153⁷⁵**
12-Pc Roll Spring (Pin) Punch Set
 • Each roll spring (pin) punch has a pilot point
 • 1/16" - 1/2"





16" Extra-Long Pin Punches

- Striking end cap
- Reduced vibration
- Lifetime warranty

Item #	Description	
LAN-856-3ST	3-Pc Set (1/4", 5/16", 3/8")	\$105.25
LAN-856-08	1/4" Pin Diameter	\$37.45
LAN-856-10	5/16" Pin Diameter	\$37.45
LAN-856-12	3/8" Pin Diameter	\$37.45



GWR-82307 **\$59¹⁵**
4-Pc Long Taper Punch Set

GWR-82309 **\$47⁵⁵**
5-Pc Pin Punch Set



MayheW Punch and Chisel Sets

Item #	Description	
MAY-62065	5-Pc 8" Long Pro Pin Punch Set, 1/8" to 3/8"	\$83.65
MAY-62254	12-Pc Pro Pilot Punch Set, 1/16" to 1/2"	\$196.35
MAY-61044	14-Pc Punch & Chisel Set (Inch)	\$163.35
MAY-61020	20-Pc Punch & Chisel Set (Inch)	\$203.95
MAY-61050	24-Pc Punch & Chisel Set (Inch)	\$290.25



GWR-82306 **\$306²⁵**
27-Pc Punch and Chisel Set
• Includes a roll pouch



OTC-4605 **\$123⁷⁵**
13-Pc Interchangeable Punch & Chisel Set



AST-1600 **\$43⁶⁵**
16-Pc Punch and Chisel Set



ATD-714 **\$80⁸⁵**
14-Pc Punch & Chisel Set

ATD-720 **\$107¹⁵**
20-Pc Punch & Chisel Set

- 6 Pin punches: 3/32", 1/8", 5/32", 3/16", 1/4", 5/16"
- 5 Starter punches: 1/8", 5/32", 3/16", 1/4", 5/16"
- 3 Center punches: 1/4", 3/8", 1/2"
- 6 Flat chisels: 1/4", 3/8", 1/2", 5/8", 3/4", 7/8"



ATD-729 **\$140⁰⁵**
29-Pc Punch & Chisel Set

- 7 Pin punches: 3/32", 1/8", 5/32", 3/16", 1/4", 5/16", 3/8"
- 6 Starter punches: 3/32", 1/8", 5/32", 3/16", 1/4", 5/16"
- 4 Center punches: 1/4", 5/16", 3/8", 1/2"
- 7 Flat chisels: 1/4", 5/16", 3/8", 1/2", 5/8", 3/4", 7/8"
- 2 Cape chisels: 1/4", 5/16"
- 1 Half-round nose chisel: 5/16"
- 2 Diamond point chisels: 5/16", 3/8"



Steel Letter & Number Stamp Sets

- 27-Pc letter sets contain: A through Z and "&"
- 9-Pc number sets contain: 0 through 9 (6 and 9 are interchangeable)



Item #	Description	
ATD-9600	Letter Set: 3" x 3/16"	\$84.65
ATD-9602	Letter Set: 3" x 1/4"	\$106.85
ATD-9601	Number Set: 3" x 3/16"	\$28.85
ATD-9603	Number Set: 3" x 1/4"	\$36.25



FOW-72-482-028-0 **\$38⁹⁵**
28-Pc Transfer Punch Set
• Range: 3/32" - 1/2"

FOW-72-482-040-0 **\$168²⁵**
36-Pc Heavy Duty Transfer Punch Set

- Sizes ideal for heavy duty applications
- Range: 1/2"-1" in 1/64"
- 3 master punches and 33 individually sized sleeves



Hooks & Picks

ATD-8424 **\$29⁹⁵**

9-Pc Scraper, Hook & Pick Set

- Includes 4 mini precision tools and 5 full size tools



TITAN



TIT-17710 **\$9⁸⁵**

4-Pc Pick and Hook Set

TIT-17224 **\$41⁵⁵**

4-Pc Jumbo Bolstered Pick and Hook Set



MUK-500 220 **\$66⁷⁵**

2-Pc Hose Removal Set



LIS-80380 **\$68⁵⁵**

5-Pc Hose Remover Set

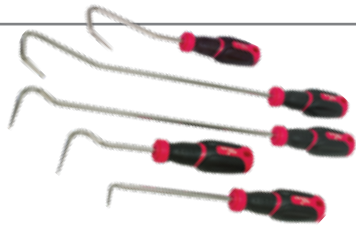

Made in USA

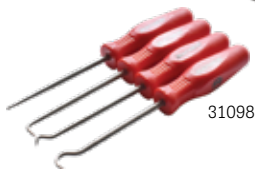

31098

4-Pc Micro Hook & Pick Set

- 5" long

\$34⁶⁵



60003

4-Pc Mini Hook & Pick Set

- 8-3/4" long

\$30¹⁵



13096

4-Pc ProGrip Hose Pick Set

- 13-3/4" long

\$112⁷⁵

GWR-84020H **\$65⁶⁵**

4-Pc Heavy-Duty Long Hook & Pick Set

- 14" overall length



GWR-84040H **\$37⁴⁵**

4-Pc Mini Hook & Pick Set

- 6-1/2" overall length



Big Hookers



Item #	Overall Length	Exposed Shaft	
SGT-13800	9-1/4"	4-1/2"	\$16.85
SGT-13810	16"	8-3/8"	\$29.25

OTC-7312 **\$14⁵⁵**

Oil Seal Pick



TITAN

TIT-17714 **\$12⁴⁵**

3-Pc Double-Ended Pick Set

- Overall length: 7-5/8"
- Non-marring composite material is flexible and strong, lightweight, non-conductive, and resists solvents

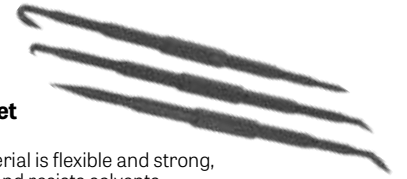

TITAN

TIT-17716 **\$15³⁵**

6-Pc Double-Ended Pick, Hook & Pry Set

- Overall lengths: 7-1/4" and 6-1/2"
- Non-marring composite material is flexible and strong, lightweight, non-conductive, and resists solvents



Seal Pullers



GWR-3245 **\$20⁹⁵**

Seal Puller

- Removes oil and grease seals on automobiles and light trucks
- Puller has 2 tip sizes for most applications



Made in USA

LAN-850 **\$40⁸⁵**

Universal Seal Puller Kit



LIS-56750 **\$20²⁵**

Seal Puller

- Designed to remove oil and grease seals



OTC-4508 **\$23⁰⁵**

Professional Style Seal Puller

- Designed to remove oil and grease seals when servicing cars, SUVs and light trucks without damaging the housing or bearing



Tool Storage

Homak



On all Homak Storage Products.



RS Pro Series Features:

- Full-length aluminum drawer pulls
- Removable ball-bearing glides in every drawer
- Custom PVC foam drawer liners included
- Lift latch drawer pulls
- 3 Power outlets in top till
- Roller cabinets with 6" casters
- Limited lifetime warranty; 1-year on paint finish.



54" RS Pro Series TOP CHEST

- 8 drawers
- 54" x 23-1/2" x 21-3/8"
- 279 lbs



Item #	
HOM-BK02065800	\$1392.95
HOM-BL02065800	\$1392.95
HOM-RD02065800	\$1392.95
HOM-LG02065800	\$1392.95
HOM-OG02065800	\$1392.95

54" RS Pro Series ROLLER CABINET

- 10 drawers
- 54-1/2" x 24" x 40-3/8"
- 370 lbs

Item #	
HOM-BK04054010	\$2094.35
HOM-BL04054010	\$2094.35
HOM-RD04054010	\$2094.35
HOM-LG04054010	\$2094.35
HOM-OG04054010	\$2094.35

Stainless Steel Tops for RS Pro Roller Cabinets



Item #	Model	Width	Weight	
HOM-SS05041244	41"	49 lbs	\$384.45	
HOM-SS05056185	54"	56 lbs	\$545.75	
HOM-SS05072185	72"	80 lbs	\$593.05	



41" RS Pro Series TOP CHEST

- 7 drawers
- 40-1/2" x 23-1/2" x 21-3/8"
- 226 lbs



Item #	
HOM-BK02004173	\$1741.45
HOM-BL02004173	\$1741.45
HOM-RD02004173	\$1741.45
HOM-LG02004173	\$1741.45
HOM-OG02004173	\$1741.45

41" RS Pro Series ROLLER CABINET

- 9 drawers
- 41" x 24" x 39"
- 308 lbs

Item #	
HOM-BK04004193	\$2423.35
HOM-BL04004193	\$2423.35
HOM-RD04004193	\$2423.35
HOM-LG04004193	\$2423.35
HOM-OG04004193	\$2423.35



72" RS Pro Series TOP CHEST

- 12 drawers
- 71-1/2" x 23-1/2" x 21-3/8"
- 393 lbs



Item #	
HOM-BK02072120	\$1892.75
HOM-BL02072120	\$1892.75
HOM-RD02072120	\$1892.75
HOM-LG02072120	\$1892.75
HOM-OG02072120	\$1892.75

72" RS Pro Series ROLLER CABINET

- 16 drawers
- 72" x 24" x 40-3/8"
- 563 lbs

Item #	
HOM-BK04072160	\$2784.85
HOM-BL04072160	\$2784.85
HOM-RD04072160	\$2784.85
HOM-LG04072160	\$2784.85
HOM-OG04072160	\$2784.85



HEAVY DUTY SERIES PROFESSIONAL TOOL STORAGE



72" HD SERIES TOP CHESTS AND ROLLING CABINETS

72" 9-Drawer Top Chest

- 2 Separate deep lids with **2 power strips**
- 19-gauge steel body
- 100 lb rated soft close drawer slides
- Pull-out work surface drawer with flip-up wood top
- PVC drawer liners and 4mm thick top chest mat
- 2 attachment plates for securing onto 72" roller cabinet
- Dimensions: 72" W x 23" D x 23" H
- Gross weight: 300 lbs

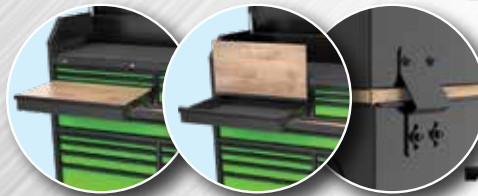

72" 15-Drawer Rolling Cabinet

- 18-gauge steel body
- 100 lb rated soft close drawer slides
(double slides on top wide drawer and 3 bottom deep drawers)
- Rated load capacity: 3,500 lbs
- Power strip on the left side wall
- 18mm wood work surface
- PVC drawer liners
- Six 6" x 2" HD casters (4 swivel with brake + 2 rigid)
- Dimensions: 72" W x 24" D x 39.5" H
- Gross weight: 516 lbs



72" HD Top Chests	6 Outlets	2 USB	72" HD Rolling Cabinets	
TBQ-TCBT720923ORBK			TBQ-RCBT721524ORBK	\$2457.45
TBQ-TCBT720923LGBK			TBQ-RCBT721524LGBK	\$2457.45
TBQ-TCBT720923RDBK			TBQ-RCBT721524RDBK	\$2457.45
TBQ-TCBT720923BLBK			TBQ-RCBT721524BLBK	\$2457.45

61" HD SERIES TOP CHESTS AND ROLLING CABINETS



****While Quantities Last ****
FREE 61" TOBEQ Top Chest
 with purchase of a matching colour 61" Roller Cabinet.

61" 6-Drawer Top Chest

- 19-gauge steel body • Deep clamshell lid with **built-in power strip**
- 100 lb rated soft close drawer slides • Privacy drawer with separate lock
- PVC drawer liners and 4mm thick top chest mat
- 2 attachment plates for securing onto 61" rolling cabinet
- Dimensions: 61" W x 23" D x 23" H • Gross weight: 262 lbs

61" 11-Drawer Rolling Cabinet

- 19-gauge steel body
- 100 lb rated soft close drawer slides (**double slides on top wide drawer and 2 bottom deep drawers**)
- Rated load capacity: 3,000 lbs
- Power strip on the right side wall
- Bulk storage with door and adjustable height shelf and storage bin
- 18mm wood work surface • PVC drawer liners
- Four 6" x 2" HD casters (2 swivel w/brake + 2 rigid)
- Dim.: 61" W x 23" D x 38.4" H • Gross weight: 383 lbs

61" HD Top Chests	6 Outlets	2 USB
TBQ-TCBT610623ORBK	\$1252.55	
TBQ-TCBT610623LGBK	\$1252.55	
TBQ-TCBT610623RDBK	\$1252.55	
TBQ-TCBT610623BLBK	\$1252.55	

61" HD Rolling Cabinets	
TBQ-RCBT611123ORBK	\$2499.95
TBQ-RCBT611123LGBK	\$2499.95
TBQ-RCBT611123RDBK	\$2499.95
TBQ-RCBT611123BLBK	\$2499.95



41" HD SERIES TOP CHESTS AND ROLLING CABINETS

****While Quantities Last ****
FREE 41" TOBEQ Top Chest
 with purchase of a matching colour 41" Roller Cabinet.

41" 4-Drawer Top Chest

- 19-gauge steel body • Deep clamshell lid with **built-in power strip**
- 100 lb rated soft close drawer slides
- PVC drawer liners and 4mm thick top chest mat
- 2 attachment plates for securing onto 41" rolling cabinet
- Dimensions: 41" W x 21.5" D x 23" H • Gross weight: 175 lbs

41" 11-Drawer Rolling Cabinet

- 19-gauge steel body
- 100 lb rated soft close drawer slides (**double slides on top wide drawer and 2 bottom deep drawers**)
- Rated load capacity: 2,500 lbs
- PVC drawer liners
- Four 6" x 2" HD casters (2 swivel with brake + 2 rigid)
- Dimensions: 41" W x 21.5" D x 40.3" H • Gross weight: 285 lbs

41" HD Top Chests	6 Outlets	2 USB
TBQ-TCBT410421ORBK	\$895.55	
TBQ-TCBT410421LGBK	\$895.55	
TBQ-TCBT410421RDBK	\$895.55	
TBQ-TCBT410421BLBK	\$895.55	

41" HD Rolling Cabinets	
TBQ-RCBT411121ORBK	\$1799.95
TBQ-RCBT411121LGBK	\$1799.95
TBQ-RCBT411121RDBK	\$1799.95
TBQ-RCBT411121BLBK	\$1799.95



TOOL STORAGE & ACCESSORIES

Tool Storage



On All Homak Storage Products.



LG02072010

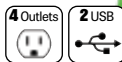

RS Pro Series Hutches

- Stainless steel shelf
- Lift latch drawer pulls
- Non-slip PVC drawer liner
- Toolboard back wall
- Power strip: 2 USB's, 4 outlets, grommet cut-outs

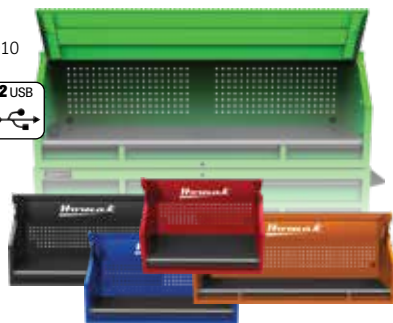

Item #	Description	Dimensions	
HOM-BK02041010	41" RS Pro Series 1-DRAWER HUTCH	W: 40-3/4"	\$1694.75
HOM-BL02041010		D: 23-1/2"	
HOM-RD02041010		H: 24-3/8"	
HOM-LG02041010		162 lbs	
HOM-OG02041010			
HOM-BK02054010	54" RS Pro Series 1-DRAWER HUTCH	W: 54"	\$2138.05
HOM-BL02054010		D: 23-1/2"	
HOM-RD02054010		H: 24-3/8"	
HOM-LG02054010		216 lbs	
HOM-OG02054010			
HOM-BK02072010	72" RS Pro Series 3-DRAWER HUTCH	W: 71.5"	\$2831.95
HOM-BL02072010		D: 23.5"	
HOM-RD02072010		H: 24-3/8"	
HOM-LG02072010		309 lbs	
HOM-OG02072010			

22" RS Pro Series Side Lockers

- 5 Drawers with lift latch pulls and PVC foam liners
- Full-length aluminum drawer pulls with black plastic end caps
- Removable ball-bearing glides in every drawer
- (2) 6" x 2" casters • 22" W x 24" D x 53-5/8" H • 205 lbs

Item #	
HOM-BK08021050	\$1946.05
HOM-BL08021050	\$1946.05
HOM-RD08021050	\$1946.05
HOM-LG08021050	\$1946.05
HOM-OG08021050	\$1946.05



14.5" RS Pro Series Side Cabinets with Stainless Steel Top

- 7 Drawers with lift latch pulls and PVC foam liners
- Full-length aluminum drawer pulls with black plastic end caps
- Removable ball-bearing glides in every drawer
- (2) 6" x 2" casters • 14-1/2" W x 24" D x 32-7/8" H • 147 lbs

Item #	
HOM-BK08014070	\$1383.35
HOM-BL08014070	\$1383.35
HOM-RD08014070	\$1383.35
HOM-LG08014070	\$1383.35
HOM-OG08014070	\$1383.35



Professional Series Top Chest & Roller Cabinet

- Double wall construction provides strength
- Reinforcement corner gussets
- Positive latching drawer retention
- Drawers equipped with 75 pound full extension ball bearing slides
- Drawer liners included at no extra charge
- Gas struts in lid of chest make lid easy to open and close
- Two point locking design adds extra security on all chests

55" TOP CHEST

- 10 drawers
- 55" W x 24" D x 28.5" H

Item #	
WLM-JHWW55TC10	
WLM-JHWW55TC10B	
WLM-JHWW55TC10BL	

55" ROLLER CABINET

- 11 drawers
- 55" W x 24" D x 39" H

Item #	
WLM-JHWW55RC11	
WLM-JHWW55RC11B	
WLM-JHWW55RC11BL	



Williams® Job Site Boxes

- Designed for the toughest outdoor work environments
- Heavy 16 gauge steel construction with 12 gauge feet
- Recessed and concealed locking area protects padlock for ultimate security against drills and bolt cutter
- Fully welded seams provide maximum strength
- Reinforced overlapping lid provides protection from weather and forced entry
- Heavy duty industrial lid stays prevents accidental closure

Item #	Colour	Dimensions W x D x H	
WLM-JHW50950B		32" x 19" x 17.5"	\$456.65
WLM-JHW50951B		42" x 20" x 23.5"	\$599.05
WLM-JHW50952B		48" x 24" x 27.5"	\$761.05

Tool Storage



MLW-48-22-8426 **\$149⁰⁵**
**PACKOUT™ Rolling Tool Box,
 250 Lbs Capacity**

- Modular connectivity with ALL PACKOUT™ components
- 9" all-terrain wheels
- Interior organizer tray
- Weather seal
- Retractable handle
- Box dim.: 22.1" W x 18.6" D x 15.5" H



#48-22-8426
 Shown in use.
 Tools not included.

MLW-48-22-8425 **\$115⁹⁵**
**PACKOUT™ Large Tool Box,
 100 Lbs Capacity**

- Modular connectivity with ALL PACKOUT™ components
- Interior organizer tray
- Weather seal
- Box dim.: 22.1" W x 16.1" D x 11.3" H



MLW-48-22-8443 **\$238⁹⁵**
**PACKOUT™ 3-Drawer Tool Box,
 50 Lbs Capacity**

- Modular connectivity with ALL PACKOUT™ components
- Ball bearing slides
- Metal reinforced corners
- Locking security bar
- Internal customizable quick-adjust dividers
- 22.1" W x 16.2" D x 14.3" H



MLW-2357-20 **\$259⁰⁵**
**M18™ PACKOUT™
 Light/Charger**

- 3,000/1,500/1,000 lumens
- Three independent pivoting light heads
- Power source: M18™ cordless or 120V corded (**battery not included**)
- 2.1 Amp USB output for USB device charging
- Small storage compartment for devices and small items
- Modular connectivity with ALL PACKOUT™ components



MLW-48-22-8488 **\$74⁹⁵**
**PACKOUT™
 Customizable Work Top,
 50 Lbs Capacity**

- Impact resistant polymer construction with 1/2" marine grade wood top
- Fastener-ready design, which allows you to attach vises, chargers, and a variety of other items for easy and secure transport
- Modular connectivity with ALL PACKOUT™ components
- 23.9" W x 15.32" D x 2.0" H



STANLEY

STST14710



014725R



**Professional
 Small Parts
 Organizers**

Item #	Description	Dimensions	
STN-STST14710	10 Removable compartments	17.5" x 14" x 4.5"	\$39.95
STN-014725R	25 Removable compartments	16.7" x 13.3" x 2.15"	\$34.65

STN-028001L **\$88⁵⁵**
**9.2 Gallon Extra Heavy Duty
 Professional FatMax® Toolbox**

- Water resistant • Portable half tray
- V-groove with ruler on lid holds materials such as lumber & pipes in place for cutting
- 27.3" L x 12.48" W x 11.31" H



STN-019151M **\$30⁴⁵**
Series 2000 Tool Box with Tray

- Two lid organizers for small parts storage – accessible without opening the tool box
- Built-in pad lock eye for small locks
- 19" L x 10" W x 10" H



STN-020800R **\$203⁵⁵**
**FatMax® 4-in-1 Heavy Duty
 Mobile Work Station**

- Storage includes toolbox, part bins, portable tray and oversized lower bin for larger items
- Telescopic handle
- Ball bearing slides
- V groove on top lid for onsite cutting needs
- Heavy duty metal latches with pad lockable eyelets
- 21.6" L x 16.2" W x 24.8" H



KNI-00 21 50 LE **\$606⁵⁵**
**Modular X18 Tool Backpack,
 33 Lbs Capacity**

- Removable tool board, • Padding for your back
- Two separate inner compartments for tools, measuring instruments, notebook or tablet
- Durable fabric, splash-proof and easy to clean
- Waterproof, impact-resistant molded bottom for a secure upright position
- A total of 21 retaining loops and 37 pockets, some with zips
- Luggage strap for fixing to telescopic handles of tool cases
- 20-7/8" x 13-3/8" x 8-1/4" • **Tools not included**

NEW



KNIPEX

Homak®

TOOL STORAGE



CASTERS CAPACITY
660LBS



CASTERS CAPACITY
520LBS



24" DEEP

100/200 LBS
DRAWER CAPACITIES

NON-SLIP
PVC DRAWER LINER

UV PROTECTIVE
FINISH

CONSTRUCTED WITH
16 GAUGE STEEL FRAME

LIFT LATCH
DRAWER PULLS

RS

PRO



CAPACITÉ DE ROULETTE
660LBS



CAPACITÉ DE ROULETTE
520LBS



24" PROFONDEUR

FINI À PROTECTION UV
100/200 LBS
CAPACITÉ DES TIROIRS:

DOIGNIÈRES DE TIROIR À LOQUET VERS LE HAUT
DOUBLURE DE TIROIR EN PVC ANTIDÉCAPANTE

CONSTRUIT AVEC UN
CADRE EN ACIER
DE CALIBRE 16

GLOBALLY
KNOWN & TRUSTED
PROFESSIONALLY
Since 1947



PLEASE CALL YOUR
DEALER FOR PRICE.

VEUILLEZ APPELER
VOTRE DISTRIBUTEUR
POUR LE PRIX.

AVAILABLE IN
27" 36" 41" 54" 72"

AVAILABLE IN
BK BL RD LG OG

DISPONIBLE EN
27" 36" 41" 54" 72"

DISPONIBLE DANS CES COULEURS
BK BL RD LG OG

Service Carts



TBQ-UC300420 **\$530¹⁵**
4-Drawer Heavy Duty Utility Cart
 • Two gas struts in lid • Keyed lock
 • Ball bearing slides
 • Aluminum drawer pulls
 • Long screwdriver holder
 • Heavy plastic protective corners
 • 5" x 2" casters with pedal brake
 • 31" L x 20" W x 40" H • Weight: 123 lbs



SUN-8005SC **\$298⁰⁵**
Multi-Purpose Service Cart
 • Load capacity: 350 lbs
 • 30" L x 16" W x 35.3" H
 • Weight: 39.33 lbs

**SUNEX
TOOLS**



SUN-8013A **\$460⁴⁵**
Service Cart with Locking Top Drawer
 • Load capacity: 350 lbs
 • 30" L x 16" W x 35.3" H
 • Weight: 64.45 lbs



SUN-8035R **\$867⁸⁵**
Compact Slide Top Utility Cart
 • Load capacity: 450 lbs
 • 29.25" L x 20.7" W x 39.4" H
 • Weight: 123.2 lbs



SUN-8013ADELUXE **\$838⁶⁵**
4-Drawer Deluxe Service Cart
 • Load capacity: 350 lbs
 • Roller bearing drawer slides
 • Locking screwdriver/pry bar holder
 • Side work shelf
 • 31" L x 17" W x 35.75" H
 • Weight: 135 lbs



SUN-8057 **\$1,145⁰⁰**
6-Drawer Service Cart
 • Load capacity: 600 lbs
 • Locking lid with gas struts
 • Roller bearing drawer slides
 • Drawer liners included
 • 34.5" L x 20" W x 39.5" H
 • Weight: 214.5 lbs



RS Pro 8-Drawer Power Service Carts

- 100 lbs drawer capacities
- Lift latch drawer pulls
- Non-slip PVC drawer liners
- Ball bearing slides
- Dedicated security compartment with power strip
- 40.5" L x 26.8" W x 42.5" H
- Weight: 319 lbs



- Dedicated cordless tool drawer with power strip



Item #	Colour	Price
HOM-BK06044080	Black	\$1899.95
HOM-BL06044080	Blue	\$1899.95
HOM-GR06044080	Grey	\$1899.95
HOM-RD06044080	Red	\$1899.95

GRI-52240 **\$149⁹⁵** **Industrial Plastic 2-Tier Service Cart**

- Load capacity: 500 lbs
- Trays: 16" x 30" x 3"
- Smooth rolling 5" casters
- 40" L x 17" W x 33" H
- Weight: 36.5 lbs



ATD **300 Lbs Capacity Heavy Duty Plastic Utility Carts**

- Trays are 3-1/2" deep
- 2 locking casters

ATD-7016 **\$208⁶⁵**
2-Tray Service Cart
 • 16" W x 30" L x 31" H
 • Weight: 21 lbs



ATD-7017 **\$281⁶⁵**
3-Tray Service Cart
 • 18" W x 32" L x 47" H
 • Weight: 27 lbs



500 Lbs Capacity Heavy Duty Plastic Utility Carts

Item #	L x W x H	Weight	Price
SUN-8034	41" x 17" x 33"	39.5 lbs	\$380.95
SUN-8036	46" x 25" x 33"	55 lbs	\$454.85

Tool Organizers

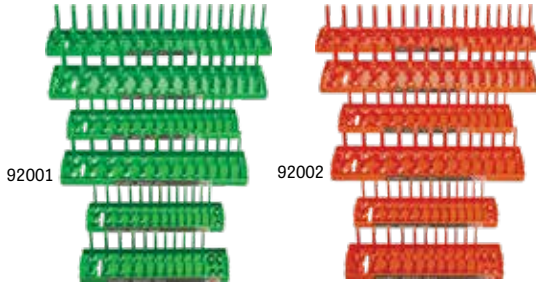

Set of 6 Socket Trays for Regular & Deep Sockets

- 1/4" metric: 4-15mm (14 slots)
- 1/4" SAE: 1/8" - 5/8" (13 slots)
- 3/8" metric: 6-20mm (15 slots)
- 3/8" SAE: 1/4" - 1" (13 slots)
- 1/2" metric: 10-27mm (17 slots)
- 1/2" SAE: 3/8" - 1-1/4" (14 slots)

Item #	Colour	
HAN-92001		\$98.25
HAN-92002		\$98.25

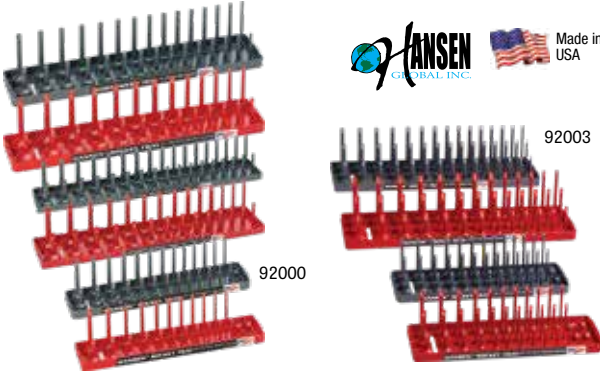

2-Row Trays for Regular and Deep Sockets

Item #	Drive	Size	Colour	Slots	
HAN-1402	1/4" Metric	4mm - 15mm		26	\$16.15
HAN-3802	3/8" Metric	6mm - 20mm		30	\$16.45
HAN-1202	1/2" Metric	10mm - 27mm		34	\$19.05
HAN-1401	1/4" SAE	1/8" - 5/8"		26	\$16.15
HAN-3801	3/8" SAE	1/4" - 1"		26	\$16.45
HAN-1201	1/2" SAE	3/8" - 1-1/4"		28	\$19.05
HAN-9302	Set of 3 Metric Grey Socket Trays Includes #: 1202, 1402, 3802				\$46.25
HAN-9301	Set of 3 SAE Red Socket Trays Includes #: 1201, 1401, 3801				\$46.25
HAN-92000	Set of 6 Red & Grey Socket Trays Includes #: 1201, 1202, 1401, 1402, 3801, 3802				\$109.15

3-Row Trays for Regular, Semi-Deep and Deep Sockets

Item #	Drive	Size	Colour	Slots	
HAN-14023	1/4" Metric	4mm - 15mm		42	\$19.15
HAN-38023	3/8" Metric	6mm - 20mm		45	\$20.55
HAN-14013	1/4" SAE	1/8" - 5/8"		39	\$19.15
HAN-38013	3/8" SAE	1/4" - 1"		39	\$20.55
HAN-92003	Set of 4 Red & Grey Socket Trays Includes #: 14013, 14023, 38013, 38023				\$77.85



VIM-V444 **\$52³⁵**
6" x 18" Socket Tray with 4 Rails
 • 20 clips in each drive size - 1/4", 3/8" & 1/2"



17" Long Socket Holder Rails



Item #	Drive / Clips	
VIM-V420	1/4" drive - 16 clips	\$9.85
VIM-V421	3/8" drive - 16 clips	\$10.45
VIM-V422	1/2" drive - 16 clips	\$10.35
VIM-V424	3/4" drive - 10 clips	\$12.55
VIM-V423	3-Pc Set: 1/4", 3/8", 1/2"	\$27.35



Magnetic Aluminum Socket Rails

- Accepts standard and deep sockets

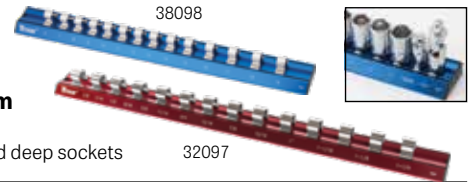

Item #	Dr.	Colour	Slots	Size Range	Rail Size	
TIT-36098	1/4"		12	4mm - 13mm, Adapter, U-Joint	8" x 1-5/16"	\$24.45
TIT-38098	3/8"		14	6mm - 19mm	12-3/4" x 1-5/16"	\$39.05
TIT-32098	1/2"		14	10mm - 22mm, U-Joint	16" x 1-5/16"	\$48.75
TIT-36097	1/4"		12	5/32" - 1/2", Adapter, U-Joint	8" x 1-5/16"	\$24.45
TIT-38097	3/8"		14	1/4" - 1", U-Joint	14-1/4" x 1-5/16"	\$39.05
TIT-32097	1/2"		14	3/8" - 1-1/4"	17" x 1-5/16"	\$48.75

Lock-A-Socket - 3-Row Socket Trays

- Accommodates for 36 sockets

Item #	Drive	
MTS-LASTRAY38	3/8"	\$54.25
MTS-LASTRAY50	1/2"	\$54.25

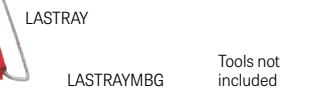

Lock-A-Socket - 5-Row Socket Trays

- Accommodates for 76 sockets
- 1/4" - 1 row, 20 posts
- 3/8" - 2 rows, 28 posts
- 1/2" - 2 rows, 28 posts

Item #	Colour	
MTS-LASTRAY	Red Tray with Black Pegs	\$89.55
MTS-LASTRAYMBG	Matte Black Tray with Green Pegs	\$93.55

Tool Organizers



LAS25MBG

LAS25



Lock-A-Socket – Single Row Socket Rails

- The underside contains a full length, high-powered, no-adhesive magnet

Item #	Colour	Drive	Locking Posts	
MTS-LAS25MBG	Mat Black/Green	1/4"	13	\$38.35
MTS-LAS38MBG	Mat Black/Green	3/8"	14	\$41.05
MTS-LAS50MBG	Mat Black/Green	1/2"	16	\$43.75
MTS-LAS25	Red	1/4"	13	\$35.25
MTS-LAS38	Red	3/8"	14	\$38.05
MTS-LAS50	Red	1/2"	16	\$40.75

Lock-A-Socket – 2-Row Socket Trays

- Accommodates all types of sockets
- No-adhesive magnet on the underside
- Simply turn the socket to lock or unlock



Item #	Drive	Posts	
MTS-LASDR25	1/4"	26	\$56.55
MTS-LASDR38	3/8"	28	\$72.35
MTS-LASDR50	1/2"	32	\$99.55



67211

2-Pc Magnetic Socket Holder Sets

- SAE and metric holders for both shallow and deep sockets

Item #	Drive	Slots	Size Range	
GRI-67209	1/4"	26	1/8" - 5/8"	\$22.25
GRI-67211	3/8"	26	1/4" - 1"	\$35.05
GRI-67215	1/2"	19	3/8" - 1-1/4"	\$37.85

EZR-FSR18-R **\$47⁷⁵** 3/8" Drive Magnetic & Ultra-Flexible Socket Holder Rack, Red

- Holds 18 sockets



Tools not included.



EZRED magnetic organizers shown in use.

EZR-FWR12-R **\$69²⁵** 12-Slot Magnetic & Ultra-Flexible Wrench Holders

- Hold 12 wrenches up to 10 lbs
- Can be used on curved or angled metal surfaces
- 12-1/4" L x 2.4" W x 0.94" H

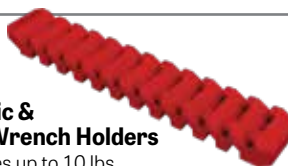

Tools not included.



EZR-WR10-RD **\$39⁴⁵** 10-Slot Magnetic Wrench Rack

- Adjustable magnetic holders
- Magnetic bottom



Easy Carry Wrench Racks

Item #	Slots	Size Range	
TIT-98012	12	8 – 19mm	\$7.65
TIT-98013	13	1/4" – 1"	\$7.65

TITAN

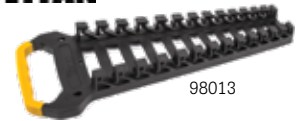

98013



Wrench Racks

Item #	Description	Slots	
VIM-V512	Stubby Wrench Gripper	10	\$18.95
VIM-V514	Wrench Gripper	15	\$22.75
VIM-V516	Wrench Rack	16	\$22.65

GEARWRENCH

GWR-83121 **\$39⁵⁵** 2-Pc 16 Slot Reversible Wrench Rack Set

- Reversible side rails with a quick-change design
- 2 side rail colours for easy differentiation
- Size range up to 1" / 25mm

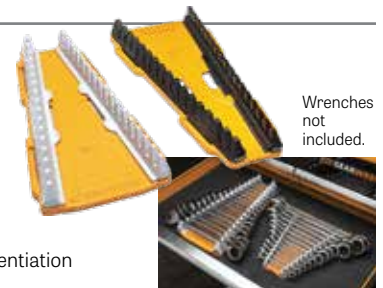

Wrenches not included.



Made in USA



13-Slot Low Profile Wrench Racks

- Sizes are pre-marked on rails (#5301 & #5302)
- Peel-off size labels in metric & SAE (#3500 & #5300)

Item #	Description	Colour	Metric	SAE	
HAN-3500	Reversed Universal	Grey	6–20mm	1/8" – 1"	\$10.65
HAN-5300	Universal	Blue	6–20mm	1/8" – 1"	\$10.65
HAN-5301	Quick-Pick SAE	Red		1/4" – 1"	\$11.75
HAN-5302	Quick-Pick Metric	Black	7–19mm		\$11.75



13-Slot Pliers & Wrench Racks

- Ten 5/8" wide slots for narrow tools and three 7/8" wide slots for larger tools
- Only 1-5/8" tall



Item #	Colour	
LIS-40460	Black	\$29.15
LIS-40490	Red	\$30.45

TOOL STORAGE & ACCESSORIES

Tool Organizers

TIT-30931 **\$19⁹⁵**
Tool Box Drawer Liner
 • 16" x 8 ft.
 • Non-adhesive gripping fabric
 • Washable • Easily cuts to size



EZRED
 EZR-EZCH3-R **\$40⁹⁵**
3-Pack Magnetic Spray Can & Cap Holder



EZRED magnetic organizers shown in use.

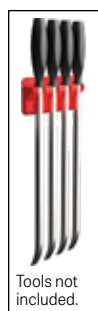

Tools not included.

EZR-EZPB4-R **\$68²⁵**
Magnetic Pry Bar Holder
 • Holds (4) pry bars

EZR-EZBIT-R **\$34⁶⁵**
Flexible Magnetic Bit Holder, Holds 48 Bits



Bits not included.



EZR-MAGMAT-R **\$59⁰⁵**
Magnetic Ultra-Flexible Tool Mat
 • Non-marring
 • Will fold, bend, or roll for use on curved or angled surfaces
 • 8.75" x 5.5"



MTS
 MTS-12X12 **\$61⁰⁵**
Magna Panel - 12"x12" Magnetic Tool Organizer

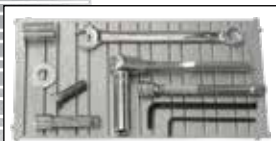
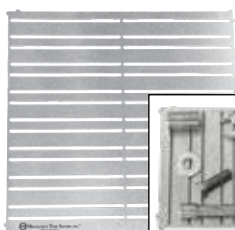

Shown in use



LIS-21400 **\$73⁸⁵**
24" Magnetic Tool Holder

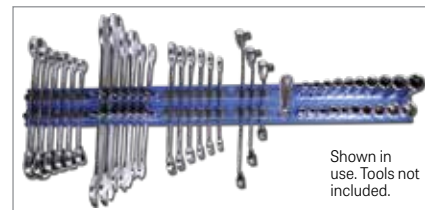

Shown in use. Tools not included.

Magrail TL - Tool Organization System

- Pick a rail, single or double width, length, colour and movable studs
- Magnetic track and backside

Item #	Length	Colour	
MAGRAIL TL - Single Width (1" Wide)			
VIM-MR12B	12"	Blue	\$48.45
VIM-MR12BK	12"	Black	\$48.45
VIM-MR12R	12"	Red	\$48.45
VIM-MR16B	16"	Blue	\$64.65
VIM-MR16BK	16"	Black	\$64.65
VIM-MR16R	16"	Red	\$64.65
VIM-MR20B	20"	Blue	\$80.75
VIM-MR20BK	20"	Black	\$80.75
VIM-MR20R	20"	Red	\$80.75
MAGRAIL TL - Double Width (2" Wide)			
VIM-MRD12B	12"	Blue	\$95.15
VIM-MRD12BK	12"	Black	\$86.45
VIM-MRD12R	12"	Red	\$86.45
VIM-MRD20B	20"	Blue	\$144.65
VIM-MRD20BK	20"	Black	\$144.65
VIM-MRD20R	20"	Red	\$144.65



Magrail TL Studs and Posts

- Universal MR-POSTS separate wrenches and other tools
- Lift rings help lift the magnetic rail



Item #	Description	Quantity	
VIM-MR-POST	1/4" Round Post/Separator	10	\$5.35
VIM-MRRL1	Lift Ring for Magrail TL	10	\$11.25
VIM-MR-SA	1/4" Studs	10	\$4.85
VIM-MR-SA100	1/4" Studs	100	\$34.85
VIM-MR-SB	3/8" Studs	10	\$6.05
VIM-MR-SB100	3/8" Studs	100	\$52.65
VIM-MR-SC	1/2" Studs	10	\$7.35
VIM-MR-SC100	1/2" Studs	100	\$63.45
VIM-MR-SD	3/4" Studs	10	\$8.95
VIM-MR-SE	1" Studs	10	\$9.85

Tool Organizers



STEELMAN^{PRO}

STE-79011 **\$26¹⁵**

Lug Bucket Magnetic Parts Holder

- Grooved dividers help separate parts while working
- 3 powerful magnets and 6 magnet positions
- Dimensions: 5" x 7" x 3.5"



8761



8762



8760



8763



Magnetic Parts Trays

Item #	Description	Size	Magnets	
ATD-8760	Round	5-3/8" diameter	1	\$11.15
ATD-8761	Rectangular	8-3/4" x 5"	2	\$24.05
ATD-8762	Square	10-3/4" x 10-3/4"	4	\$44.75
ATD-8763	Large Rectangular	14" x 6"	3	\$31.55



GRI-67486

\$10¹⁵

8" Magnetic Storage Tray

- 1" deep



EZR-EZTRAY-CLR **\$37⁹⁵**

Set of 3 Collapsible Magnetic Trays, 4" x 4"

- Expands from 3/4" to 2"



QUAD Expandable Magnetic Trays

- Expands from 3/4" to 2"
- Magnets on the inside hold loose parts
- 9" x 9" x 3/4"



\$51⁶⁵

EZR-EZTRAY-QRD
Red

\$51⁶⁵

EZR-EZTRAY-QGR
Vert



VIM-RTT20

\$95⁹⁵

20" Low Profile Rolling Tool Tray

- Center metal plate to attach any magnetic tray or light with magnetic base



TOOLGRID[®]

ORGANIZATION SYSTEM

Customizable Tool Organization System

- Tools not included

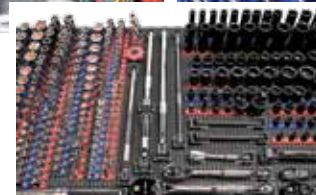

Item #	Description	Pieces	
TLG-SOCKETBDL400	*1/4", 3/8", 1/2" Drive Socket Bundle	397 Holders 400 Screws	\$208.65
TLG-WRENCHBDL200	*Wrench Bundle – Metric & SAE	200 Holders 200 Screws	\$150.35
TLG-HANDBDL150	*Hand Tool Bundle (Pliers & Screwdrivers)	148 Holders 200 Screws	\$162.75
TLG-34DRBDL100	*3/4" Drive Socket & Ratchet Bundle	98 Holders 100 Screws	\$104.85
TLG-CONTBDL52	*Container & Divider Bundle	52 Contain./Dividers 100 Screws	\$85.55
TLG-52000	TG-04, Board 24-1/2" x 26-1/16"	1	\$63.55
TLG-52001	TG-05, Board 29-1/16" x 26-1/16"	1	\$75.35
TLG-52002	TG-06, Board 15-7/8" x 26-1/16"	1	\$44.95
TLG-52003	TG-10, Board 24-1/2" x 22-3/16"	1	\$55.65

* The Toolgrid™ board is not included in the bundles.

www.MANTISCANADA.com

TGB-6X6 – 6" x 6" Modular Boards

- Fully customizable and fun to configure!
- TGB-6X6 boards work with all Toolgrid holders and screws and are compatible with the original Toolgrid boards
- Trim off the right amount, for a perfect fit
- Each colour is sold in packs of 16



Item #	Colour	
TLG-52015	White	\$135.45
TLG-52016	Black	\$135.45
TLG-52017	Grey	\$135.45
TLG-52018	Blue	\$135.45
TLG-52019	Red	\$135.45
TLG-52020	Yellow	\$135.45
TLG-52021	Green	\$135.45



Tool Belts

\$185⁸⁵



MLW-48-22-8120

Contractor's Belt with Suspension Rig

- 24 pockets
- Smart phone pocket
- Fits 30" to 53" waists



Gear, Bearing & Pulley Pullers / Splitters



Mechanical Grip-O-Matic® Gear & Bearing Pullers

- Remove and install parts for fast, effective repairs



Item #	Capacity	Style	Max. Reach	Max. Spread	
OTC-1020	1-Ton	2-Jaw	2-1/8"	3-1/4"	\$73.15
OTC-1021	1-Ton	3-Jaw	2-1/8"	3-1/4"	\$84.65
OTC-1022	2-Ton	2-Jaw (Rev. Jaws)	3-1/4"	4"	\$78.95
OTC-1023	2-Ton	2/3-Jaw (Rev. Jaws)	3-1/4"	4-3/4"	\$95.35
OTC-1024	5-Ton	2-Jaw (Rev. Jaws)	3-1/4"	6"	\$152.05
OTC-1026	5-Ton	2/3-Jaw (Rev. Jaws)	3-1/4"	7"	\$252.45
OTC-1025	5-Ton	2-Jaw (Rev. Jaws)	5-1/2"	6"	\$185.85
OTC-1027	5-Ton	2/3-Jaw (Rev. Jaws)	5-1/2"	7"	\$315.75
OTC-1035	7-Ton	2-Jaw (Rev. Jaws)	5"	9"	\$165.55
OTC-1037	7-Ton	2/3-Jaw (Rev. Jaws)	5"	10-1/2"	\$238.05
OTC-1036	7-Ton	2-Jaw	8-3/4"	11"	\$151.55
OTC-1038	7-Ton	2/3-Jaw	8-3/4"	11"	\$206.95
OTC-1039	13-Ton	2-Jaw	11"	12"	\$244.45
OTC-1041	13-Ton	2/3-Jaw	11"	12"	\$512.75

3-in 1 "GripLock" Pullers

- 2 or 3 jaw application
- Both external and internal pulling action



Item #	Capacity	Max. Reach	Max. Spread	
OTC-464	2-Ton	4"	3" - 4"	\$151.55
OTC-465	5-Ton	7"	3" - 7"	\$255.85

OTC-522 **\$137⁶⁵**

Large Gear & Pulley Puller

- Easily remove a wide range of gears, pulleys, or other parts that have tapped holes
- Puller spread is 2" to 7-3/4"
- Forcing screw is 3/4" - 16 x 11-5/8" long



OTC-7393 **\$78²⁵**

Gear & Pulley Puller

- Perfect for removing timing gears, fan pulleys, harmonic balancers, and many other parts having tapped holes
- Puller spread: 1-1/2" to 4-1/4"



OTC-6614 **\$216⁸⁵**

Heavy-Duty Gear Puller

- Removes gears up to 7-1/4" in diameter, including most cam gears
- Rated at 8 tons, for most heavy-duty applications; includes a pair of M12x1.75" x 90mm metric bolts



Push Pullers

- To remove and install press-fit parts

Item #	Capacity	Max. Reach	Max. Spread	
OTC-927	10-Ton	8-1/4"	2-1/8" - 7-1/4"	\$254.05
OTC-938	17-1/2 Ton	11-1/2"	3-1/8" - 11-3/4"	\$473.25
OTC-939	30-Ton	10-1/2"	7" - 16-1/4"	\$889.35

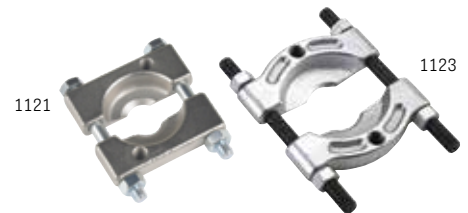

Bearing Splitters

Item #	Maximum Spread	Minimum Spread	
OTC-1121	15/16"	1/4"	\$82.65
OTC-1122	2"	1/8"	\$96.45
OTC-1123	4-5/8"	1/2"	\$161.55
OTC-1124	5-3/4"	1/2"	\$328.65
OTC-1130	9"	1/2"	\$374.65
OTC-1126	8"	5/8"	\$552.15
OTC-1127	13-3/8"	3/4"	\$1326.15

OTC-4518 **\$242²⁵**

5-Ton Bar-Type Puller/Bearing Separator Set

- Set includes two most popular 2" and 3" bearing splitters



OTC-4534 **\$309⁶⁵**

Multipurpose Bearing & Pulley Puller Set

- For a wide range of pulling jobs, including: bearings, alternators, generators, power steering and crankshaft pulleys, timing gears, and harmonic balancers

Gear, Bearing & Pulley Pullers / Splitters



ATD-3056 **\$123⁰⁵** 5 Ton Bar-Type Puller/ Bearing Splitter Set

- Perfect for a wide variety of pulling jobs
- Can be used separately or with other pullers or tools



K-2030-10+S



K-2030-20+S



K-2030-10-S

Universal 2-Jaw & 3-Jaw Puller Sets

- Reversible for internal and external applications
- For removing bearings, gears, discs, etc.

K-2030-20-S

	KKU-K-2030-10+S	KKU-K-2030-10-S	KKU-K-2030-20+S	KKU-K-2030-20-S
Capacity	5-Ton	5-Ton	10-Ton	10-Ton
Jaw Type	Narrow Jaws with Quick-Adjust Knobs	Narrow Jaws	Stand. & Narrow Jaws with Quick-Adjust Knobs	Standard & Narrow Jaws
2-Jaw Width	1-3/16" to 4-3/4" (30-120mm)		1-5/8" to 7-7/8" (40-200mm)	
2-Jaw Depth	3-7/8" to 13-3/4" (100-350mm)		5-7/8" to 23-5/8" (150-600mm)	
3-Jaw Width	1-1/16" to 5-1/8" (27-130mm)		1-3/8" to 7-7/8" (35-200mm)	
3-Jaw Depth	3-7/8" to 13-3/4" (100-350mm)		5-7/8" to 17-23/32" (150-450mm)	
	\$1254.75	\$1296.25	\$2050.05	\$1822.25

K-22-A



K-22-B



Internal (Blind Hole) Puller Sets with Counterstay & Slide Hammer

- For extracting inner bearings, bearing outer rings and bushings

Item #	Application	Inner Diameter of Ball Bearing	
KKU-K-22-A	Automotive	1/4" - 1-3/16" (6mm-30mm)	\$722.45
KKU-K-22-B	Industrial	1-1/8" - 2-3/4" (28mm-70mm)	\$1106.15



SUN-3909 **\$330⁷⁵** 10 Ton Capacity Hydraulic Gear Puller

- Provides up to 10 ton of pulling force with hydraulic ram
- Makes 8 different pulling combinations for total versatility



GRI-21120 **\$87⁰⁵** 3-Pc 3-Jaw Gear Puller Set

- Removes gears, pulleys, bearings and flywheels
- 3", 4", 6"



MUK-650 200 **\$367³⁵** Universal Race Puller

- Universal three-legged bearing ring puller provides equal gripping power on each side, avoiding any tilt
- Adjustable clamping chain offers ideal grip and power
- Fits all kinds of bearings and sleeves between 40mm and 60 mm
- For manual use, not with an impact tool



OTC-7494A **\$120⁵⁵** Rear Axle Bearing Puller Set

- For the removal of semi-floating rear axle bearings
- Set includes three pullers: 1" to 1-7/8", 1-5/16" to 2-3/8", 1-3/8" to 2-7/8"



9CL-40291 **\$640¹⁵** 16-Pc Blind Hole Bearing Puller & Slide Hammer Set

- 8mm to 58mm, M10 x 1.50, M8 x 1.25, M6 x 1.00



CAL-29 **\$358⁶⁵** Blind Hole Bearing Puller

- 2.5 lbs slide hammer
- Includes 4 collets: 3/8" - 1/2" (10-14mm), 9/16" - 11/16" (15-19mm), 5/8" - 1" (18-25mm), 1" - 1-1/4" (25-32mm)



Flange-Type Pullers

OTC-6930 **\$86⁷⁵** **OTC**
Flange-Type Puller Combination

- Pulls harmonic balancers, timing gears and parts having two or three tapped holes



OTC-525 **\$166⁶⁵** **OTC**
Flange-Type Puller Kit

- Flange-type puller for removal of harmonic balancers, timing gears, and other parts with two or three tapped holes
- Puller for removal of steering wheel, pulley, and flywheel



OTC-7790 **\$232⁸⁵** **OTC**
48-Pc Flange-Type Puller Set

- Versatile puller capable of removing a wide variety of components having tapped pulling holes, including harmonic balancers, gears, crankshaft pulleys, etc.



Slide Hammer Pullers

Astro

AST-78415 **\$104⁹⁵**
Locking Pliers Slide Hammer

- Universal puller
- 2.5 lbs slide hammer



TOOL AID[®]
PROFESSIONAL AUTOMOTIVE TOOLS



SGT-66370 **\$357⁵⁵**
10 Lb Slide Hammer & Pullers for Front Wheel Hubs and Rear Axles

- Pullers fit 4, 5 and 6 bolt patterns for use on most domestic and imported cars and light trucks

Cal-Van TOOLS

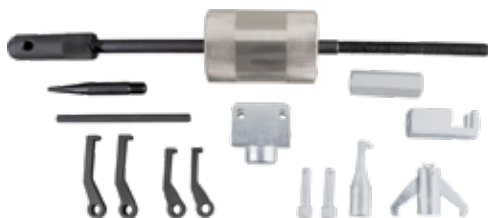

CAL-49700 **\$134³⁵**
14-Pc Slide Hammer and Puller Set

- 2 lb. slide hammer
- Can be used to pull seals, bearings, pressed studs, or even for straightening body panels
- Capable of inside spreads from 3/8" to 1-1/4" and outer spreads up to 3"
- Puller reaches depths up to 2-1/2"

OTC-7703 **\$170⁹⁵** **OTC**
10 Lb Heavy-Duty Slide Hammer Puller

- 24" long
- 5/8" - 18 threaded end adapts to any of OTC's pulling attachments



OTC-4579 **\$244⁶⁵**
9-Way Slide Hammer Puller Set

- 5 lb hammer
- Pulls flange-type rear axles and most front-wheel drive hubs
- Pulls bearings, gears and seals
- Dent puller attachment for sheet metal or other unique pulling requirements



SUNEX[®]
TOOLS

SUN-3911 **\$189⁸⁵**
5 Lb. Slide Hammer Puller

- Jaws can be set up for 2 or 3 jaw internal or external pulling

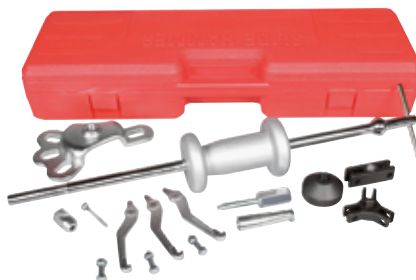

OTC-7947 **\$424⁶⁵**
8-Way Slide Hammer Puller Set

- 5 lb. hammer
- Use for 2/3-way internal or external jobs. Pull flange-type rear axles, stubborn oil seals and bearings, and other press-fit parts



Power Steering & Alternator Pulley Pullers



LAN-5238 **\$179⁸⁵**

Master Power Steering Pulley Remover and Installer Set

- Designed to remove and install press-on-type belt-driven accessory pulleys found on most major domestic vehicle platforms
- Applications include: GM Quad 4, GM 3.1L and Ford 4.6L engines



OTC-6359 **\$314²⁵**
Power Steering Pulley Puller

- Also used to remove alternator pulley on Chrysler vehicles
 - Similar to Miller #MLR-C-4333A
- Applications:
- Chrysler 2006-2008 Pacifica, Sebring, Town & Country
 - Jeep 2006 - 2008 Liberty, Wrangler
 - Dodge 2006 - 2008 Stratus, Caravan, Grand Caravan PT Cruiser
 - Plymouth 2006 - 2008 Grand Voyager, Voyager



LIS-57650 **\$51²⁵**
Alternator Decoupler Pulley Tool Kit

- For removing and installing many alternator decoupler pulleys (one way and overriding/freewheeling) on the most popular domestic vehicles



OTC-7830A **\$169⁴⁵**

Power Steering Pump Pulley Kit

- Removes and installs power steering pump pulleys in Chrysler, Ford, and GM vehicles with Saginaw, Thompson, and Ford C111 and C2 power steering pumps



OTC-6358 **\$160³⁵**
Alternator Decoupler Pulley Remover & Installer Tool

- 10mm male and female ends
- Applications include 2004+ Chrysler/Dodge/Jeep vehicles
- Similar to Miller #MLR-8433A



OTC-4529 **\$87⁴⁵**

Power Steering/Alternator Pulley Puller/Installer Set

- Properly replaces pressed-on power steering and alternator pulleys on Ford, Chrysler, and late GM engines



OTC-4530 **\$88⁶⁵**
Power Steering Pump Pulley Remover/Installer Set

- Works on most domestic vehicles
- Fits pulley hubs with diameters of 1-1/8", 1-1/4", 1-5/16" and 1-3/8"
- Includes the necessary adapters for servicing: GM 3.1 L, 3100, 3400, and 3800 V6 engines, GM 2.3L Quad 4 four-cylinder engines and Ford 4.6L, 5.4L, and 5.8L modular V8 engines



OTC-7185 **\$80¹⁵**
Power Steering Pump Pulley Puller

- Removes power steering pulleys on most Ford, Chrysler, VW, and GM vehicles with Saginaw, Thompson, and Ford C2 and C111 power steering



Steering Wheel/Column Pullers



ATD-3052 **\$108¹⁵**
Alternator/Power Steering Pulley Puller and Installer

- Remove pressed-on alternator and power steering pulleys on late model GM, Ford & Chrysler engines
- Installs late model GM alternator & power steering pulleys, incl. Quad 4
- Puller fits AMC vehicles



ATD-3059 **\$182³⁵**
Steering Wheel Remover & Steering Column Service Tool Set

- For most domestic and import vehicles with standard or tilt/telescoping columns



Harmonic Balancer Pullers

CAL-38000 **\$131⁹⁵**

Ratcheting Harmonic Balancer Puller

- Three ratcheting legs with puller feet eliminate the need for bolts
- Applications:
 - Ford 5.0 Coyote
 - GM 5.3L, 5.7(LS1), 6.0(LS2), 6.2(LS3), 7.0L
 - Most 3 and 6 spoke harmonic balancers/pulleys



LIS-51450 **\$165⁴⁵**

Harmonic Damper Pulley Puller

- For Chrysler, GM, Mitsubishi, and Dodge



OTC-4531 **\$260⁷⁵**

Harmonic Balancer Puller/Installer Set

- For easy removal and installation of most press-fitted harmonic balancers and drive pulleys
- Harmonic balancers adapter sizes included: M16 x 2.0, M14 x 1.5, M12 x 1.5, 1/2"-20, 7/16"-20, 3/4"-16, 5/8"-18, and 9/16"-18



OTC-6667 **\$160⁵⁵**

Harmonic Balancer Puller

- Designed for removing damper pulleys in tight engine compartments, without removing the radiator
- Covers many GM, Cadillac, Chevrolet trucks, Chrysler, Ford, Mitsubishi Eclipse models



OTC-6669 **\$189⁹⁵**

Harmonic Balancer Puller Kit

Applications:

- GM 2000 Generation III 4.8L, 5.3L, 5.7L 6.0L, and 8.1L V8s
- Cadillac 4.5, 4.6, and 4.9L V8s beginning in 1988
- Chevrolet trucks 2003+ 4.2L I6, 2004-current 3.5L I5; 2005-current 2.8L I4
- Chrysler engines from 1990+, including 2.0L, 2.4L-cyl; plus 2.5L, 2.7L, 3.3L, 3.5L, and 3.8L V6s
- Ford 1995+ V8 engines with 3 spoke pressed-on damper
- Mitsubishi Eclipse 1995-1999 2.0L DOHC non-turbo
- Saab 9-7X: 200-2009 4.2L, 5.3L, 6.0L
- Volkswagen Routan: 2009-2010 4.0L



Lisle

LIS-54810 **\$379⁴⁵**

Master Harmonic Balancer Puller Set

- Removes most automotive harmonic balancers



TOOLS
SIBLEY PRODUCTS INC.

Harmonic Balancer Pulley Puller Kits with Side-Turn Legs



Item #	Jaws	Applications	
SLY-17400	2-Jaw	Low-profile, narrow design for smaller cars with 4-spoke pulleys	\$268.05
SLY-18350	3-Jaw	GM 3.6L Camaro, 2018+ Ford Coyote engines and other vehicles equipped with 3-spoke and 6-spoke pulleys	\$362.15

SLY-18000 **\$593⁹⁵**

15-Pc Master Harmonic Damper Pulley Puller Set

- 4 pulley puller kits in one: #64900B, #18350, #17400 and #13450A
- This kit accommodates a multitude of applications that include, but are no limited to:
 - 2018+ Ford Coyote engines as well as various models and production years of GM/Chevrolet and other vehicles equipped with 3- and 6-spoke pulleys
 - Many Ford, Dodge, Chrysler, GM and other domestic vehicles as well as some import vehicles and compact cars equipped with 3-, 4- and 6-spoke pulleys

TOOLS
SIBLEY PRODUCTS INC.



AST-78450 **\$114²⁵**

Heavy-Duty Harmonic Crank Pulley Puller

- For use on three winged style crank pulley dampeners without female threaded holes
- Works on: GM LS, Ford Coyote, GMC, Chrysler, Dodge & Jeep



Drum & Rotor Pullers

AST-78830 **\$282¹⁵**

Heavy Duty Hub, Drum & Rotor Puller Kit

- Impact grade
- Small, medium and large hub adapters



OTC-6980 **\$279⁴⁵**

Brake Drum and Rotor Puller

- Handles large components such as brake drums, rotors, drive wheels, gears, flywheels, and pulleys
- Spread to 12-3/4" and 5" of reach
- 7-tons of force



OTC-6979 **\$525⁸⁵**

Heavy Duty Brake Drum and Rotor Puller

- Designed for removing frozen, rusted or seized drums and rotors found on 1-ton pickups, school buses and larger vehicles
- Spread to 17.5" and a max. reach of 12.25"



Slack Adjuster Pullers

TIGER TOOL



TGR-10406 **\$298¹⁵**

Manual Slack Adjuster Puller

- Safely and efficiently removes all makes and models of manual slack adjusters
- Eliminates dangerous hammering and cutting torch methods
- Can be used with a 1/2" impact tool



TGR-10409 **\$298¹⁵**

Gunite/Brunner/Bendix Slack Adjuster Puller

- Can be used with a 1/2" impact tool



TGR-10410 **\$365³⁵**

Haldex Multi Adjustable Slack Adjuster Puller

- Can be used with a 1/2" impact tool



TGR-20602 **\$1522⁴⁵**

Slack Adjuster Service Kit

- Works with all major brands of manual and automatic self-adjusting type slack adjusters

Kit includes:

- Manual slack adjuster puller
- Rockwell slack adjuster puller
- Gunite/Brunner/Bendix slack adjuster puller
- Haldex slack adjuster puller, including left offset, right offset, and standard elongated arm designs from either side
- Brake clevis pin press
- Slack adjuster rod pin press



OTC

OTC-5055 **\$255⁷⁵**

Heavy-Duty Manual Slack Adjuster Puller

- Puller fits many manual types



OTC-5056 **\$258²⁵**

Heavy-Duty Automatic Slack Adjuster Puller

- Works on Rockwell, Haldex, Gunite, and Bendix automatic adjusters

U-Joint Pullers

U-Joint Pullers

- Three sizes to work on many cars, trucks and agricultural equipment



Item #	Size	Applications	Bearing Caps	
LIS-42890	Small	Cars, L-Duty Trucks, Farm Equip.	1" to 1.25"	\$108.15
LIS-42900	Medium	Cars, M-Duty Trucks, Farm Equip.	1.25" to 1.7"	\$149.35
LIS-42910	Large	Class 7 & 8 Trucks	1.5" to 2.2"	\$279.95



U-Joint Pullers

- For disassembling even the most seized U-joints in minutes on virtually all cars, light-duty trucks and farm machinery



Item #	Size	Applications	Bearing Caps	
CAL-905	Small	Cars, L-Duty Trucks, Farm Equip.	1" to 1.25"	\$117.25
CAL-199	Large	Class 7 & 8 Trucks	1.5" to 2.2"	\$267.95

OTC-5190A **\$559⁴⁵**

Heavy-Duty U-Joint Puller

- Designed to fit all Class 7 and 8 trucks, including a wide variety of drivelines from Spicer and Meritor



CAL-20300 **\$310³⁵**

Heavy-Duty U-Joint Bearing Cup Installer

- Applications: Dana®/Spicer® SPL 140, 170, and 250 Series U-joints found in Class 6-8 commercial vehicles and equipment

TIGER TOOL

TGR-10102 **\$367⁴⁵**

Commercial U-Joint Puller

- Commonly found on class 6-8 transportation trucks and equipment (Kenworth, Peterbilt, Freightliner, Mack, Volvo, etc.)
- U-joints with bearing cups 1.5" to 2.2" O.D.
- Spicer 1610, 1710, 1760, 1810, 1880 Series
- Spicer SPL 140, 170, & 250 Life Series
- Meritor (Rockwell) 16N, 17N, 18N, 1710 Series
- Meritor RPL 20, 25 Permalube Series



TGR-10201 **\$133³⁵**

Bolt-Retained Bearing Cap Installer

- Commonly found on Class 6-8 transportation trucks and equipment

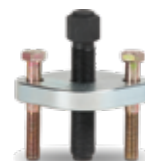

TGR-20175 **\$839⁹⁵**

Heavy-Duty Truck Driveline Service Kit

Kit includes:

- #10102 - Heavy-duty U-joint puller
- #10803 - Heavy-duty yoke puller



Wheel Hub Pullers



Made in Canada

TBQ-1190A **\$522²⁵**

Universal Axle Shaft Puller

- Improved model
- 15 lbs slide hammer



TBQ-1197 **\$797⁶⁵**

Universal Axle Shaft Puller & Pusher Super Kit

- Includes #TBQ-1190A and #TBQ-1196



TBQ-1195 **\$518¹⁵**

Drive Shaft Pusher/Hub Puller with Extractor Jaw

- Includes #TBQ-1193 and #TBQ-1196

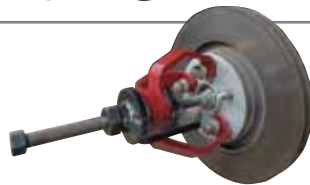

TBQ-1193 **\$267²⁵**

Three Adapter Legs

- Works with older model #CVO-1190



TBQ-1196 **\$354⁹⁵**

Extractor Jaw with 30cm Push Screw



MUK-433 414 **\$387¹⁵**

Original "VIBRO-IMPACT" Universal Drive Shaft Pusher/Hub Puller

- Pushes out bonded or heavily corroded drive shafts
- Suitable for almost all 4- and 5-hole wheel hubs with a pitch circle diameter up to 136 mm
- For use with an impact wrench



KKU-229-2 **\$700¹⁵**

10-Ton Capacity Hydraulic Wheel Hub Puller

- For all 4 and 5-hole hubs on almost all passenger cars, including VW, Audi, Volvo, Fiat, etc.
- Also for extracting drive shafts for vehicles with front wheel drive



OTC-6575 **\$1173⁴⁵**

Hub Grappler™ Wheel Hub Service Kit

- For servicing wheel hubs and bearings on the vehicle without removing the steering components or knuckle
- Coverage up to 2018 model year
- Includes tie rod/ball joint tool and 2 Ford axle installers



OTC-6575H

Hydraulic Hub Grappler™ Kit

- Same as #OTC-6575 but also includes the Hydraulic Kit



OTC-6574 **\$315⁷⁵**

Universal Heavy-Duty Hub Puller with Plate

- For use on frozen hubs, axle shafts, and other tough pulling applications
- Fits wheel hubs with 5"-8"+ bolt circles



OTC-6575-1 **\$385⁴⁵**

Hub Grappler™ Puller

Yoke Pullers

TGR-10803 **\$524⁹⁵**

Heavy-Duty Yoke Puller

- For the removal of heavy-duty yokes on drive shafts, transmissions and rear-end differentials without damage to yokes or other components

Applications:

- Yokes with a bearing diameter between 1-7/8" and 2-3/16"
- Spicer and Meritor 1610, 1710, 1760, 1810 Series
- Spicer SPL 140, 170, 250 Series
- Meritor/Rockwell RPL 20, 25 Series



TIGER TOOL

TGR-10850 **\$257⁷⁵**

Automotive Yoke Puller

- Commonly found on Class 1-2 trucks, cars and equipment. (Ford F-150/350, Chevrolet 1500/3500, Ram 1500/3500, etc.)



CAL-497 **\$493⁸⁵**

Heavy-Duty Yoke Puller

- For the removal of heavy-duty yokes on driveshafts, transmissions, and drive axles without damage to yokes or other components
- Services an extensive range of Class 6-8 trucks
- Fits on multiple Spicer full and half round yokes
- Fits on Meritor (Rockwell) RPL 20 & 25 series



Cal-Van TOOLS

LIS-60050 **\$373²⁵**

Commercial Heavy-Duty Yoke Puller

- Used to remove commercial heavy-duty yokes on transmissions and rear-end differentials
- For use on yokes with a bearing diameter between 1-7/8" and 2-3/16" commonly found on Class 6-8 trucks



Pitman Arm Pullers



LIS-41970 **\$67⁶⁵**
Heavy-Duty Pitman Arm Puller for Ford

- For the large Pitman arms on 2005 and later Ford F250 and F350 trucks



OTC-7314A **\$80¹⁵** **OTC**
Pitman Arm Puller

- Will handle nearly any Pitman arm job on passenger cars and light trucks
- Spread between jaw tips: 1-5/16"



OTC-6496 **\$161⁵⁵**
Pitman Arm Puller

- New design saves time and increases productivity
- Works on most domestic 4WD SUVs and pickups



OTC-6497 **\$181⁶⁵**
Super-Duty Pitman Arm Puller

- Works on 2005 and newer Ford F-250 and F-350 4WD Super-Duty trucks
- Maximum jaw spread is 3-1/4"



TIGER TOOL

TI Made in Canada



TGR-10385 **\$241⁴⁵**
Sheppard M100 Pitman Arm Puller

TGR-10389 **\$356⁹⁵**
Sheppard M110 Pitman Arm Puller



SLY-11880A **\$676⁸⁵**
Large Pitman Arm Remover

- Works with Ford F250/F350 and many 3/4 to 1 ton pickup trucks using the larger TRW steering box, and now the F450/F550 models with ZF steering gear



SLY-14900 **\$552⁵⁵**
Sheppard Pitman Arm Remover

- Applications:
- M80, M90, M100, M110, 292, 392, 492 & 592
 - Used on Chevy/GMC, Freightliner, Kenworth, Mack, Navistar, Paccar, Peterbuilt, Volvo, and many others



Tie Rod Pullers

OTC-7503 **\$127¹⁵**
5 Ton Capacity Outer Tie Rod Remover

- Works on FWD and RWD import and domestic vehicles



OTC-7503HD **\$253⁵⁵**
10 Ton Capacity Universal Heavy Duty Tie Rod and Ball Joint Remover

- For use on a variety of cars, trucks, SUVs and heavy-duty vehicles
- 3" jaw spread and 4" reach for a wider variety of applications and larger vehicles
- Forcing screw: 3/4"-10, 6.5" long
- Interchangeable tips including cone, flat and cup for multiple applications
- The tool will also remove pitman arms and can be used in many pulling situations that require a 2 jaw puller on other vehicles types and machinery



Dent Pullers



SGT-81100 **\$464⁸⁵**
The Slugger - 10 Lb. Dent Puller & Slide Hammer



SGT-81500 **\$95³⁵**
Junior Slugger - 3 Lb. Dent Puller & Slide Hammer



Wiper Arm / Battery Terminal Pullers

9CIRCLE®
 9CL-83170 **\$147⁷⁵**
5-Pc Wiper Arm Puller Set

- Includes 4 cup extractors and 1 adjustable puller to work on a wide range of applications



LIS-54150 **\$41⁸⁵**
Battery Terminal & Wiper Arm Puller



GWR-202D **\$30⁶⁵**
Battery Terminal Puller

Bottle Jacks



Bottle Jacks

Item #	Capacity	Lift Height		Weight	
		Low	High		
Hydraulic Bottle Jacks					
NRC-76502B	2-Ton	7.13"	14.5"	6 lbs	\$115.95
NRC-76503B	3-Ton	7.5"	15.56"	8 lbs	\$132.45
NRC-76505B	5-Ton	9.06"	18.88"	11.5 lbs	\$175.95
NRC-76508B	8-Ton	9.06"	18.75"	14 lbs	\$202.15
NRC-76512B	12.5-Ton	6.69"	13.19"	15 lbs	\$212.45
NRC-76412B	12.5-Ton	9.45"	18.9"	18 lbs	\$220.55
NRC-76820B	22-Ton	8.27"	14.96"	25 lbs	\$316.55
NRC-76520B	22-Ton	10.83"	20.2"	31 lbs	\$326.75
NRC-76560	60-Ton	12"	18.75"	82 lbs	\$978.45
Air/Hydraulic Bottle Jacks					
NRC-76320B	20-Ton	10.88"	20.5"	41 lbs	\$645.35
NRC-76350	50-Ton	12"	19"	70 lbs	\$1030.55
NRC-76399	100-Ton	11.8"	17.7"	190 lbs	\$3473.15



ESC-10450 **\$313⁹⁵**
20-Ton Air/Manual Bottle Jack
 • Extension screw gives added height
 • Min./Max. height: 10.3"/19.2"
 • Weight: 35 lbs



ESC-10382 **\$365⁷⁵**
Pro Series 20-Ton "Shorty" Air/Hydraulic Bottle Jack
 • Min. height: 7-1/8"
 • Max. height: 12-5/8"
 • Weight: 34 lbs



ESC-10383 **\$551⁴⁵**
Pro Series 30-Ton Air/Hydraulic Bottle Jack
 • Min. height: 10-7/8"
 • Max. height: 20" • Weight: 63 lbs



Bottle Jacks

Item #	Capacity	Lift Height		Weight	
		Low	High		
Hydraulic Bottle Jacks					
SUN-4402	2-Ton	7.1"	13.6"	5.5 lbs	\$55.45
SUN-4404	4-Ton	7.6"	14.7"	7.3 lbs	\$60.45
SUN-4406	6-Ton	8.3"	16.3"	9.9 lbs	\$84.55
SUN-4408	8-Ton	9.1"	18.1"	11.5 lbs	\$95.75
SUN-4412S	12-Ton Short	7.5"	14.4"	12.8 lbs	\$149.95
SUN-4412	12-Ton	9.1"	17.3"	14.3 lbs	\$109.85
SUN-4420S	20-Ton Short	7.5"	13.8"	17.9 lbs	\$200.15
SUN-4420	20-Ton	9.5"	17.8"	20.5 lbs	\$186.05
SUN-4430	30-Ton	11"	17.5"	26.9 lbs	\$430.05
Air/Hydraulic Bottle Jacks					
SUN-4412AH	12-Ton	9.6"	18.7"	29.8 lbs	\$365.55
SUN-4420AH	20-Ton	9.6"	18.7"	38.8 lbs	\$539.95



Professional Hydraulic Bottle Jacks

Item #	Capacity	Lift Height		Weight	
		Low	High		
TBQ-BJH02000	2-Ton	6"	12.1	5.3 lbs	\$35.85
TBQ-BJH04000	4-Ton	7.7"	14.7"	6.4 lbs	\$41.05
TBQ-BJH08000	8-Ton	7.9"	14.9"	9.7 lbs	\$59.75
TBQ-BJH12000	12-Ton	8"	15.4"	13.2 lbs	\$67.05
TBQ-BJHS12000	12-Ton Low Profile	7.5"	13.8"	12.1 lbs	\$64.55
TBQ-BJH20000	20-Ton	9.6"	17.5"	21 lbs	\$98.15
TBQ-BJHS20000	20-Ton Low Profile	7.5"	13.4"	18.7 lbs	\$94.15
TBQ-BJH30000	30-Ton	10"	17.9"	38.6 lbs	\$177.55

Bottle Jacks

TBQ-ABJH20000A **\$209⁹⁵**

20-Ton Heavy Duty Air/Manual Bottle Jack

- Minimum height: 10-1/8"
- Maximum height: 19-13/16"
- Ram travel: 6.5"
- Screw adjustment: 3-3/16"
- Weight: 33.4 lbs



TBQ-ABJL20000A **\$230⁵⁵**

20-Ton Heavy Duty Low Profile Air/Manual Bottle Jack

- Minimum height: 6-15/16"
- Maximum height: 12-11/16"
- Ram travel: 3-3/8"
- Screw adjustment: 2-3/8"
- Weight: 28.5 lbs



AST-5302A **\$334⁰⁵**

20-Ton Air/Manual Bottle Jack

- Minimum height: 10-3/8"
- Maximum height: 20-1/16"
- Lift: 5.16" • Screw: 3.15"



AST-5304A **\$315⁰⁵**

20-Ton Low Profile Air/Manual Bottle Jack

- Minimum height: 7"
- Maximum height: 12.75"
- Lift: 3-3/8" • Screw: 2-3/8"



Floor Jacks

Floor Service Jacks

SUNEX
TOOLS

Item #	Capacity	Lift Height		Chassis Length	Weight	
		Low	High			
Hydraulic Floor Jacks						
SUN-6602LP	2-Ton	2.75"	24"	36"	97 lbs	\$530.95
SUN-6602ASJ Aluminum Body	2-Ton	3.5"	20"	26.5"	58 lbs	\$630.25
SUN-6604	5-Ton	5"	22"	55.5"	225 lbs	\$1499.95
SUN-6609	10-Ton	6.25"	22.5"	61"	359 lbs	
Air/Hydraulic Floor Jacks						
SUN-6606	5-Ton	5"	22"	55.5"	230 lbs	
SUN-6614	10-Ton	6.25"	22.5"	61"	364 lbs	
SUN-6620	20-Ton	7.3"	24.6"	59"	589 lbs	



Floor Service Jacks

norco

On all Norco Floor Jacks

Item #	Capacity	Lift Height		Chassis Length	Weight	
		Low	High			
Hydraulic Floor Jacks						
NRC-71233B	2-Ton	2-3/4"	20"	27-7/8"	92 lbs	\$549.45
NRC-71331 FASTACK	3-Ton	3"	19-3/4"	31"	71 lbs	\$649.45
NRC-71335A	3.5-Ton	4"	21-3/8"	28-1/2"	106 lbs	\$669.95
NRC-71500G FASTACK	5-Ton	5-5/8"	27-1/4"	62-1/4"	270 lbs	
NRC-71000D FASTACK	10-Ton	6-1/8"	27-1/4"	69-1/2"	455 lbs	
Air/Hydraulic Floor Jacks						
NRC-71550G FASTACK	5-Ton	5-5/8"	27-1/4"	62-1/4"	270 lbs	
NRC-71100A FASTACK	10-Ton	6-1/8"	27-1/4"	68-1/2"	466 lbs	
NRC-72230A	20-Ton	7-1/4"	26-1/4"	71-1/2"	670 lbs	



Floor Jacks



LDJ35



HDJ5
HDJ10

HDJ20

LDJA2

HDJ5P
HDJ10P

Floor Service Jacks

Item #	Capacity	Lift Height		Chassis Length	Weight	
		Low	High			
Hydraulic Floor Jacks						
OTC-LDJA2	2-Ton	3.25"	18.625"	25.125"	47 lbs	\$749.05
OTC-LDJ35	3.5-Ton	5.2"	21.9"	28.5"	100 lbs	\$597.05
OTC-HDJ5	5-Ton	6"	22"	56"	254 lbs	\$1795.95
OTC-HDJ10	10-Ton	5"	22"	55.5"	280 lbs	\$2011.15
OTC-HDJ20	20-Ton	6.25"	22.5"	61"	561 lbs	
Air/Hydraulic Floor Jacks						
OTC-HDJ5P	5-Ton	5.875"	22"	55.5"	375 lbs	\$1750.55
OTC-HDJ10P	10-Ton	6.375"	22"	61"	410 lbs	\$3650.45



TBQ-SJ03500A **\$249⁹⁵**
3.5-Ton Floor Jack with Double Pump Technology
 • Min. height: 4-3/4"
 • Max. height: 18-1/8"
 • Weight: 68.2 lbs



CPT-80021 **\$624⁰⁵**
2-Ton Low Profile Service Jack
 • Min. height: 3"
 • Max. height: 19.9"
 • Weight: 86 lbs



CPT-80031 **\$708⁵⁵**
3-Ton Low Profile Service Jack
 • Min. height: 3.7"
 • Max. height: 21.7"
 • Weight: 99.2 lbs



BHK-B6350 **\$400⁷⁵**
3.5-Ton Fast Lift Service Jack
 • Min. height: 5.25"
 • Max. height: 20"
 • Weight: 89.10 lbs



7344B



7317



7343A

Floor Service Jacks

Item #	Capacity	Frame	Lift Height		Weight	
			Low	High		
ATD-7344B	1.5-Ton	Aluminum	3.125"	14"	35.6 lbs	\$498.75
ATD-7317	2-Ton	Steel	2.75"	24"	106 lbs	\$799.65
ATD-7343A	3-Ton	Aluminum	3.74"	18.9"	57.3 lbs	\$1041.55

Floor Jacks



OTC-LDJA2-SET **\$1010⁵⁵**

2-Ton Aluminum Racing Jack Pack

2-ton service jack (OTC-LDJA2):

- Min./Max. height: 3-1/4" / 18-5/8"
- Weight: 47 lbs

Pair of 2 ton jack stands (OTC-SA02):

- Min./Max. height: 9.5" / 15.2"
- Weight: 4.6 lbs



OME-25055B **\$642¹⁵**

2.5-Ton Magic Lift Service Jack and 3-Ton Jack Stands Combo

2.5-ton low profile service jack:

- Min./Max. height: 3.35" / 19.3"
- Weight: 69.5 lbs

3-ton jack stands:

- The rated capacity is per pair
- Min./Max. height: 11.5" / 17"
- Weight: 16 lbs



ATD-7500 **\$482⁹⁵**

3-Ton Jack Pack

3-ton service jack:

- Min. height: 5-3/8"
- Max. height: 19-1/2"
- Weight: 78 lbs

Pair of 3 ton jack stands:

- Min. height: 11-13/16"
- Max. height: 7-5/16"
- Weight: 15 lbs



\$ While Qtys. Last

SUN-6603ASJPK **\$574⁹⁵**

3-Ton Aluminum Service Jack Pack

3 ton service jack (#6603ASJ):

- Min. height: 3.8"
- Max. height: 19.3"

Pair of 3 ton jack stands (#1003AJ):

- Height range: 10.6" to 15.4"



Air/Hydraulic Axle Jacks



Air/Hydraulic Jacks

Item #	Capacity	Lift Height		Weight	
		Low	High		
TBQ-AJ22000A	22-Ton	8-3/4"	17-11/16"	72.6 lbs	\$794.55
TBQ-TAJ40200	40/20-Ton	5.9"	16.1"	79.4 lbs	\$1651.85
TBQ-AJ50000	50-Ton	11-3/8"	21-1/4"	101.2 lbs	\$1193.35
TBQ-TAJ53150	50/30/15-Ton	5.9"	17"	123.5 lbs	\$2268.75
TBQ-TAJ60000	60-Ton	16.5"	40.6"	278 lbs	\$3411.35

NRC-72200D **\$1596⁷⁵**

22-Ton Capacity Air/Hydraulic Axle Jack

- Min./Max height: 9"/22"
- Weight: 115 lbs



NRC-72218

33/20-Ton Capacity Air/Hydraulic Floor Jack

- Min./Max height: 6"/12"
- Weight: 100 lbs



10771



ESC-10771

50/30/15-Ton Capacity Air/Hydraulic Service Jack

- Min. Height: 5.5"
- Max. Height: 11.9"
- Weight: 143 lbs

LIFTING EQUIPMENT

Air/Hydraulic Axle Jacks

CPT-85030 
30/15-Ton Air/Hydraulic Axle Jack

- Min. height: 5.9"
- Max. height: 16.1"
- Weight: 84 lbs



CPT-85050 
50/25/15-Ton Air/Hydraulic Axle Jack

- Min. height: 6.3"
- Max. height: 18.5"
- Weight: 132 lbs



OTC-UA22 **\$1460¹⁵**
22-Ton Capacity Air/Hydraulic Under Axle Jack

- Min. height: 8.27"
- Max. height: 20-7/8"
- Weight: 110 lbs





OTC-UA27 
27.5-Ton Cap. Air/Hydraulic Under Axle Jack

- Min. height: 8-1/4"
- Max. height: 21-3/8"
- Weight: 128 lbs



Truck Jacks

Item #	Capacity	Lift Height		Weight	
		Low	High		
SUN-6622	22-Ton	9"	21"	119 lbs	\$1011.55
SUN-6822	22-Ton	8.75"	22.2"	90.2 lbs	\$1558.65
SUN-6635	22/35-Ton	8.625"	19.75"	119 lbs	\$1615.45
SUN-6744	44-Ton	8.25"	21"	95 lbs	
SUN-6855	55/33/16.5-Ton	5.9"	16.75"	129 lbs	

Air Lift Jacks

SUN-6710 
10-Ton Portable Air Lift Jack

- Low height: 17-3/4"
- Extended height: 49"
- Weight: 187 lbs



Portable Air Lift Jacks

Item #	Capacity	Lift Height		Weight	
		Low	High		
NRC-82990C	10-Ton	17-3/4"	49-3/8"	178 lbs	\$1558.75
NRC-82992	15-Ton	18-1/8"	51-3/8"	240 lbs	



OTC-1591B 
10-Ton Combination Air Lift & Stand

- Min. height: 18-3/4"
- Max. height: 50-1/2"
- Weight: 187 lbs

End Lift Jacks

NRC-82999AI 
10-Ton Capacity End Lift Air Jack

- For lifting entire front or rear of a vehicle
- Low lift height: 12.25"
- High lift height: 49.5"
- Saddle reach: 13.5"
- Weight: 817 lbs



OTC-1590 
10-Ton Capacity End Lift Air Jack

- Low lift height: 13"
- High lift height: 52"
- Saddle spread: 29" to 41-3/4"
- Weight: 709 lbs



Off-Road/Manual Jacks

APP-14100 **\$210⁵⁵**
4-Ton Power Jack

- A must for the off-roader
- Lightweight for easy use
- Low pick up, lifting nose only 4.5" from the base
- 4" long lifting nose • Safety shear pin • Lifetime warranty

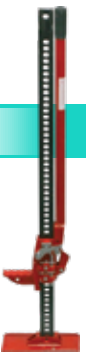

Jack Stands



SUNEX
TOOLS



Jack Stands
• Sold in pairs

Item #	Capacity	Lift Height		Net Weight	
		Low	High		
Ratcheting Jack Stands					
SUN-1003C	3-Ton	11-5/8"	16-3/4"	15 lbs	\$89.55
SUN-1006C	6-Ton	15-3/4"	24"	30 lbs	\$156.05
SUN-1012C	12-Ton	19-1/2"	30"	71 lbs	\$406.05
Pin Type Jack Stands					
SUN-1210	10-Ton	11"	17.3"	58 lbs	\$328.95
SUN-1410	10-Ton	28.1"	46.5"	115.6 lbs	\$481.25
SUN-1522A	22-Ton	11.8"	19.7"	72.7 lbs	\$332.55



Jack Stands
• Sold in pairs

Item #	Origin	Capacity (each stand)	Lift Height		Weight
			Low	High	
Jack Stands with Lock Handle					
NRC-81004C	Imported	3 Tons	12"	17-1/2"	19 lbs \$101.45
NRC-81012	Imported	12 Tons	19-5/8"	29-3/8"	86 lbs \$424.85
Jack Stands - Pin Type with Square Base					
NRC-81205	USA	5 Tons	9-1/2"	15-3/4"	38 lbs \$479.95
NRC-81205i	Imported	5 Tons	9-1/2"	15-3/4"	38 lbs \$245.05
NRC-81225	USA	25 Tons	12"	20"	65 lbs \$853.75
NRC-81225i	Imported	25 Tons	12"	20"	65 lbs \$500.35
Jack Stands - Pin Type with Four Legged Base					
NRC-81208i	Imported	10 Tons	10-1/2"	17"	60 lbs \$416.65
NRC-81209	USA	10 Tons	18-1/2"	30"	80 lbs \$964.45
NRC-81209i	Imported	10 Tons	18-1/2"	30"	80 lbs \$551.45
NRC-81210	USA	10 Tons	28"	47"	106 lbs \$1196.55
NRC-81210i	Imported	10 Tons	28"	47"	106 lbs \$714.85



TUBER Pair of Jack Stands

Item #	Capacity	Lift Height		Net Weight	
		Low	High		
Ratcheting Jack Stands • Spring loaded for quick lifting					
TBQ-JS06000B	6-Ton	15-7/16"	23-5/16"	32 lbs	\$107.15
TBQ-JS12000B	12-Ton	18-7/8"	29-1/8"	68 lbs	\$219.45
Pin Type Jack Stands					
TBQ-JS22000B	22-Ton	12-3/8"	19-5/8"	61 lbs	\$246.95

Ratchet Style Jack Stands

• Sold in pairs



Item #	Capacity	Height	
ATD-7443A	3-Ton	11-13/16" – 17.5"	\$117.55
ATD-7446A	6-Ton	15-7/8" – 24.5"	\$188.75



OTC-SA02 **\$187.05**
2-Ton Aluminum Jack Stands (Pair)
• Min. height: 9.5"
• Max. height 15.44"



12-Ton Capacity Jack Stands

• Sold individually

Item #	Height Range	
OTC-1778B	19" – 29-1/2"	\$637.65
OTC-1779B	33-3/4" – 44-1/4"	\$727.35



ESC-10459 **\$452.25**
22 Ton EZ-Wheel Jack Stands (Pair)
• Easy to wheel and maneuver with included extended handle
• 3 height positions: 13.5"/16.5"/20"



ESC-10456 **\$464.15**
22-Ton Jack Stands (Pair)
• Adjustable screw top saddle
• 3 height positions: 15.5"/17.5"/20.5"
• Saddle extension: 2"
• Max. height: 22.5"



LIFTING EQUIPMENT

Jack Stands



10802
10803



20-Ton Screw Style Jack Stands

- Adjustable screw for height extension/retraction
- Sold per stand

Item #	Height	Weight	
ESC-10802	16.5" – 26.5"	65 lbs	\$427.55
ESC-10803	24" – 46"	82 lbs	\$623.85



ESC-10804 **\$453⁰⁵**

25-Ton Pin Style Jack Stand

- Pin adjustable height
- Min./Max. height: 27" / 41"
- Weight: 79 lbs • Sold per stand



ESC-10493 **\$978⁰⁵**

10-Ton Heavy-Duty High-Lift Jack Stand

- Foldable tripod stand
- Three-spring loaded wheels
- Min./Max. height: 43" / 69-1/4"
- Weight: 200 lbs • Sold per stand

AME-14361 **\$106⁵⁵**

4-Ton Flat Top Jack Stands (Pair)

- Flat top rubber pad grips the lifting point
- 2 tons per stand
- Min. height: 13.8"
- Max. height: 21.81"



\$612³⁵

20-Ton OTR (Off-The-Road) Screw Style Jack Stand

- Min. height: 26"
- Max. height: 46"



\$449⁹⁵

24-Ton Heavy Duty Jack Stands (Pair)

- 12 tons per stand
- Min. height: 12"
- Max. height: 18"



\$414⁶⁵

40-Ton Heavy Duty Jack Stands (Pair)

- 20 tons per stand
- Min. height: 12"
- Max. height: 20"

AME-14401 **\$565⁶⁵**

44-Ton Heavy Duty Pin Style Jack Stands with Wheels and Handle (Pair)

- 22 tons per stand
- Wheels and 2-pc handle for easy placement and maneuverability
- Min. height: 13"
- Max. height: 20"



Rams & Accessories



ESC-10316 **\$492⁰⁵**

10-Ton Stak-Able Hydraulic Ram Kit

- Ideal for low clearance applications
- 1", 2" and 3" extensions, .375" saddle
- Retracted height: 3.5" • Max. height: 11.25"



10-Ton Hydraulic Rams

- Used to break the beads on the backside of the tire • 3-year warranty

Item #	Retracted Height	Stroke	
ESC-10301	4.75"	2-1/8"	\$406.65
ESC-10302	6.75"	4-1/8"	\$434.45
ESC-10303	9.75"	6-1/8"	\$473.45
ESC-10304	11.75"	8"	\$525.45
ESC-10305	13.75"	10-1/8"	\$545.85



High Flow Hydraulic Couplers

- Interchange with Enerpac C604 and Power Team/OTC 9795



Item #	Description	
AME-16000	Male & Female Set	\$79.95
AME-16050	Male End	\$35.95
AME-16060	Female End	\$39.95



Foot Pumps



SUNEX
TOOLS

SUN-4998 **\$598⁹⁵**
Air/Hydraulic Foot Pump

- Develops 10,000 PSI
- 98 cu. in. of usable oil



NRC-910130A **\$590²⁵**
Air/Hydraulic Foot Pump with 10,000 PSI Capacity

- Aluminum reservoir



OTC-2510A **\$687⁵⁵**
Air/Hydraulic Foot Pump

- Develops 10,000 PSI
- 98 cu. in. of usable oil



ESC-10518 **\$705⁵⁵**
Pro Series 1/2 Gallon Air/Hydraulic Foot Pump

- Develops 10,000 PSI
- High volume 135 cu. in. of usable oil

Transmission Jacks



On all TOBEQ Transmission Jacks

Transmission Jacks

Item #	Capacity	Low Height	High Height	Weight	
TBQ-TJ00500A	1/2-Ton	32-7/16"	69-5/8"	107 lbs	\$799.95
TBQ-TJ01000	1-Ton	33-1/4"	72-1/4"	158 lbs	\$1190.25
TBQ-TJ01500	1.5-Ton	7.85"	36.2"	319 lbs	\$1862.05

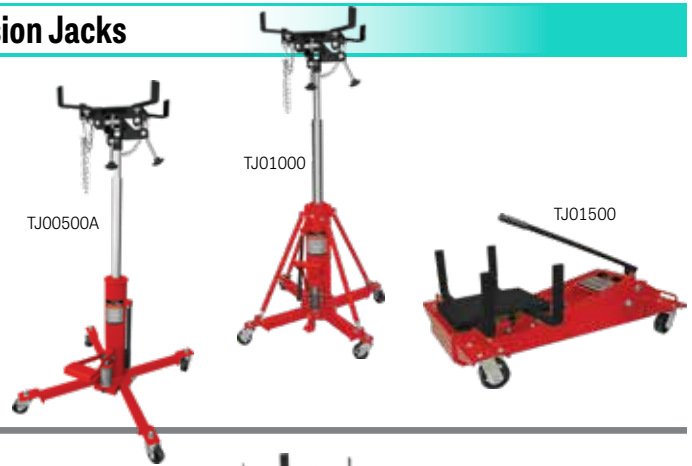

On all Sunex Transmission Jacks

Telescopic Transmission Jacks

Item #	Capacity	Low Height	High Height	Weight	
SUN-7700C	1/3-Ton	50.8"	70.5"	68 lbs	\$543.15
SUN-7793B	1/2-Ton	35.5"	75.5"	171 lbs	
SUN-7796	1/2-Ton Air/Hydraulic	35.5"	73.5"	167 lbs	



Low Profile Transmission Jack

Item #	Capacity	Low Height	High Height	Weight	
SUN-7752C	1.5-Ton	8.6"	36.6"	300 lbs	



On all Norco Transmission Jacks

Under Hoist Transmission Jacks

Item #	Capacity	Lift Height		Base Dim.	Weight (Lbs)	
		Low	High			
Hydraulic Under Hoist Transmission Jacks						
NRC-72550B <i>FASTACK</i>	1/2-Ton	35"	72"	34" x 37"	178	
NRC-72700A	1-Ton	45-3/4"	74-1/4"	38" x 38"	292	
Air/Hydraulic Under Hoist Transmission Jacks						
NRC-72450B <i>FASTACK</i>	1/2-Ton	36"	75"	34" x 34"	175	
NRC-72475A <i>FASTACK</i>	3/4-Ton	36-1/2"	75-1/4"	36" x 36"	196	



Transmission Jacks

Item #	Capac.	Lift Height		Overall Dim.		Weight (Lbs)	
		Low	High	Length	Width		
Hydraulic Transmission Jacks							
NRC-72050E	1/2-Ton	7-3/8"	32-1/8"	36"	26-1/2"	152	\$1036.55
NRC-72025 <i>Wide Chassis</i>	1.5-Ton	4-3/4"	36-1/2"	43-1/4"	32-3/4"	414	
NRC-72000E	1.5-Ton	7-3/4"	36-1/2"	45"	28"	310	
NRC-72000Ei	1.5-Ton	7-3/4"	36-1/2"	45"	28"	310	

LIFTING EQUIPMENT

Transmission Jacks

OTC

OTC-1522A



2,000 Lbs Capacity Low Lift Transmission Jack

- Includes adapter plate for Eaton® Fuller® RoadRanger® transmissions
- Height range: 6-7/8" to 35-1/4"
- Weight: 352 lbs



OTC

OTC-5019A



2,000 Lbs Capacity Low-Lift Transmission Jack

- Special mounting adapter fits popular Eaton® Fuller® RoadRanger® transmissions used on nearly all Class 7 and 8 heavy-duty trucks
- Min. height: 8-1/4" • Max. height: 36-1/2"
- Weight: 376 lbs



OTC

OTC-TJH10



1,000 Lbs Capacity High-Lift Transmission Jack

- Universal saddle, adjustable corner brackets and safety chains
- Head tilts front to back and side to side
- Min. height: 35"
- Max. height: 71-5/8"
- Weight: 158 lbs



OTC

OTC-5078



2,000 Lbs Capacity High-Lift Transmission Jack for Trucks & Buses

- Foot-operated air pump
- Includes an adapter for Allison 500 and 600 series automatic transmissions
- Min. height: 41-1/2"
- Max. height: 65"
- Weight: 312 lbs



**HEIN-WERNER
AUTOMOTIVE**

HWA-HW93718



1-Ton Manual Floor Transmission Jack

- Designed for heavy duty transmissions
- Low height: 10.25"
- High height: 45.25"
- Base: 47.5" x 28.25"
- Weight: 309 lbs



Engine Lifting Equipment & Accessories

**SUNEX
TOOLS**



8300GB

SUN-8300GB **\$797⁶⁵** 1/2-Ton Capacity Folding Engine Stand

- 63 to 1 ratio gearbox easily rotates engine to desired position by turning a crank handle
- Overall length x width: 38.6" x 35.8"
- Weight: 96 lbs



8400

SUN-8400 **\$510⁴⁵** 1-Ton Capacity Folding Engine Stand

- 8 locking positions secure the engine at multiple angles for different applications
- Overall length x width: 41.7" x 28.5"
- Weight: 132 lbs

**SUNEX
TOOLS**

SUN-8300DP **\$80⁰⁵** Oil Drip Pan for Engine Stand

- For use on engine stands with "T" or "I" shaped bases



NORCO

NRC-78230



2,000 Lbs Capacity 75:1 Gear-Driven Engine Stand

- Capable of handling large automotive engines and small diesel engines
- Height: 42"
- Width (front): 21-1/4" (rear): 40"
- Length: 38-1/4" – 53-1/4"
- Weight: 289 lbs



OTC

OTC-1735B



2,000 Lbs Capacity Heavy-Duty Motor-Rotor® Universal Repair Stand

- Handles a wide variety of engines, transmissions, torque converters, and rear axles from trucks, tractors, and construction machinery
- Universal arm assemblies
- Dimensions: 59" x 24" x 16"
- Weight: 290 lbs



Engine Lifting Equipment & Accessories

NORCO

NRC-72850A

2,500 Lbs Capacity Powertrain Lift/Work Table

- Handles powertrain components like engines, transmissions, transaxle assemblies, rear ends and large electric vehicle batteries
- Air/hydraulic foot pump
- Lift height: 31" to 78"
- Overall dim.: 50" L x 33" W x 35" H
- Table size: 19" x 36"
- Saddle tilt: 15°
- Weight: 665 lbs



OTC

OTC-1585A

1,250 Lbs Capacity Power Train Lift with Tilting Plate

- Ideal for engine and transaxle service
- Height range: 29-1/2" to 68-1/2"
- Weight: 372 lbs



ATD-7478

2,500 Lbs Capacity Powertrain Lifting Table

- Designed to handle heavy engine, drive axle assemblies, transmissions, electric vehicle batteries and other vehicle components
- Air/hydraulic foot pump
- Capacity @ 100 psi: 2,500 lbs
- Lifting range: 33" - 77"
- Table size: 19.7" x 32"
- Table tilt: +/- 11°
- Overall dim.: 48" x 33" x 33"
- Weight: 586 lbs



OTC

OTC-1750A

6,000 Lbs Capacity Revolver® Diesel Engine Stand

- Rotates components 360°; handle locks in any position
- Universal adapter assembly permits use with a wide variety of mounting plates
- Weight: 722 lbs



SUN-5222 **\$1051⁸⁵**

2-Ton Engine Crane

- Folding, space-saving design
- Dual pump pistons rapidly reach max height
- 4 boom positions adjust for optimal reach based on required capacity
- Weight: 225 lbs

SUNEX
TOOLS

SUNEX
TOOLS

SUN-5207

Engine Transverse Bar with Arm Support

- Extends from 34.5" to 61"



APP-PP7136

\$58⁰⁵

Engine Lift Sling Combo™

- Lifts up to 600 lbs
- Use either slip hooks or engine bolt attachments
- Use as a sling or engine lift



AMERICAN
POWER PULL

OTC-4305

\$161¹⁵

1,500 Lbs Capacity Engine Load Leveler

- Designed to hook to a crane or hoist to handle and position large, bulky components
- Adjustable horizontal tilt



NORCO

NRC-78099

\$371⁷⁵

700 Lbs. Capacity 4-Point Engine Support Tool

- Fully adjustable, up to 47-1/2"



OTC-7100

\$106⁵⁵

Pair of Lifting Brackets, 4,000 Lbs Capacity

- Attach directly to component for easy lifting
- Will take 1/2" diameter bolts



Under Hoist Stands

NORCO

\$259³⁵

NRC-81034A
3/4-Ton Capacity Under Hoist Stand with Foot Pedal

- Designed to support vehicle components, not the vehicle
- Low height: 55-1/4"
- Extended height: 81-1/2"
- Weight: 40 lbs

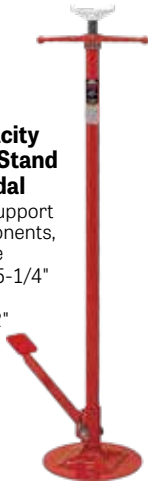

NORCO

\$273⁶⁵

NRC-81035A
1.5-Ton Capacity Under Hoist Stand

- To assist in stabilizing and supporting a vehicle that is raised by an in-ground or above-ground lift. Should be used in pairs.
- Low height: 48-7/8"
- Extended height: 85-3/8"
- Weight: 48 lbs



TORBEQ

\$179⁹⁵

TBQ-UHS03400A
3/4 Ton Capacity Under Hoist Stand

- Cast iron handle
- Height adjustment spin handle
- Height adjustment: 53-1/2" to 80"
- Base diameter: 12"
- Weight: 31 lbs

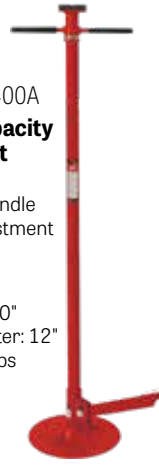

TORBEQ

\$225²⁵

TBQ-UHS01500A
1.5 Ton Capacity Heavy Duty Under Hoist Stand

- Adjustable saddle screw for additional height
- Large saddle with rubber pad
- Five height adjustments ranging from 49-1/4" to 79-15/16"
- Weight: 35.2 lbs



SUNEX TOOLS

\$214²⁵

SUN-6809A
3/4-Ton Capacity Under Hoist Stand

- Designed to support vehicle components only
- Low height: 53"
- Extended height: 79"
- Weight: 29 lbs



OTC

\$238⁰⁵

OTC-UH15
1,500 Lbs Capacity Underhoist Auxiliary Stand

- Min. height: 54-1/4"
- Max. height: 80-3/4"

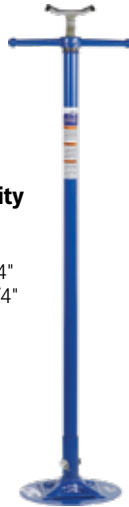

OTC

\$265³⁵

OTC-UH15FP
1,500 Lbs Capacity Underhoist Auxiliary Stand with Foot Pedal

- Min. height: 54-1/4"
- Max. height: 80-3/4"



OTC

\$377⁷⁵

OTC-UH20
2-Ton Capacity High Reach Underhoist Supplementary Stand

- Min. height: 56-1/4"
- Max. height: 85"



Trailer Stabilizing Stands

SUNEX TOOLS

SUN-1622 **\$350⁴⁵**
20-Ton Capacity Trailer Stabilizing Stand

- Designed to stabilize and assist in supporting the front or rear of a tractorless trailer
- Low height: 39"
- Extended height: 50-1/2"
- Weight: 55 lbs



NORCO

20-Ton Capacity Trailer Stabilizing Stand

- To stabilize and assist in supporting the front or rear end of a loaded or unloaded tractorless trailer
- Low height: 39"
- Extended height: 50-5/8"
- Weight: 55 lbs

Item #	Origin	Price
NRC-81022B	USA	\$620.85
NRC-81022Bi	Imported	\$526.95



NORCO

NRC-81050 **\$1098⁵⁵**
50-Ton Capacity Trailer Stabilizing Stand

- Static load cap.: 100,000 lbs
- Lifting capacity: 15,000 lbs
- Removable pipe handle
- Low height: 39"
- Extended height: 51"
- Base diameter: 14"
- Saddle diameter: 8"
- Weight: 152 lbs



Truck Ramps



ATD-7321A **\$1838¹⁵**
20-Ton Capacity
Pair of Truck Ramps
 (10 ton each ramp)
 • Accepts tire widths up to 15.5"
 • Telescopic T-handle
 • Weight: 348 lbs



20-Ton Capacity
Pair of Truck Ramps
 • 10 ton each ramp
 • Telescopic 34" T-handle



Item #	Max. Tread Width	L x W x H	Ship Weight	
NRC-82019	10"	48.25" x 12.625" x 9"	204 lbs	\$1180.55
NRC-82020	16"	50.5" x 18.375" x 9.25"	346 lbs	\$1620.85

Vehicle Positioning Dollies



Vehicle Positioning Dollies

- For normal shop use, standard "Right Hand" units are all you need
- The "Left Hand" version is useful if the car is disabled and the front tire is turned at an extreme angle. In this situation, the foot pedal on the "Left Hand" GoJak is oriented to point out of the wheel well.

Item #	Pedal Style	Max. Tire W x D	Max. Cap. Per Dolly	Max. Vehicle Cap. (4 Dollies)	
GOJ-G5211	Right	11" x 34"	1,300 lbs	5,200 lbs	\$487.85
GOJ-G6313	Right	13" X 36"	1,575 lbs	6,300 lbs	\$519.35
GOJ-G6313L	Left	13" X 36"	1,575 lbs	6,300 lbs	\$519.35

ATD-7466 **\$161⁰⁵**
Car Dollies - Set of 2
 • Capacity: 1,500 lbs per dolly
 • 3" casters (2 locking)
 • 12" x 16" x 4.8"



ATD-7465 **\$265³⁵**
Hydraulic Vehicle Position Jack
 • Capacity: 1,500 lbs per jack
 • Tire capacity: up to 12" wide
 • Min./Max. Opening: 13.58" / 21.6"



OTC-1580 **\$407³⁵**
Stinger® Easy Roller™ Hydraulic Vehicle Position Jack
 • Capacity: 1,500 lbs per jack
 • Fits tread widths up to 12"



Wheel Dollies / Tire Carts



GAI-GTJ-01 **\$199⁸⁵**
TRAC Tire Jack - Tire & Wheel Assembly Assistance Cart for Tire Rotations & Installs
 • 350 lbs capacity
 • Allows to remove or install a tire from a vehicle near the ground, by simply sliding it under the tire and carrying it off or on the vehicle
 • Manipulate tires without lifting with your back
 • Steel construction with convenient rollers



JDI-JDI-TT1 **\$122⁵⁵**
Tire Taxi™
 • Maximum load of 265 lbs
 • Transports 5 tire and wheel assemblies or up to 8 tires



GAI-GTRP-01 **\$124³⁵**
TRAC Roller Plate Accessory
 • For use with the TRAC Tire Jack
 • Allows for an easier alignment of the holes of the wheel to the studs of the hub
 • Heavy-duty welded steel construction



SUN-1501 **\$1095³⁵**
1,500 Lbs Capacity Hydraulic Wheel Dolly
 • For the removal, installation, and transportation of single, tandem, and duplex tire and wheel combinations up to 52" diameter
 • Lift range: 0" to 9.25"
 • Lift arm spread: 21" to 25"
 • Overall dim.: 31" L x 43" W x 35" H
 • Weight: 143 lbs



Wheel Dollies / Tire Carts

TBQ-WD01500A **\$829⁰⁵**

1,500 Lbs Capacity Hydraulic Wheel Dolly

- Lift arms can be adjusted to handle different wheel combinations
- Safety chain for securing loads
- Lift arm length: 25-3/16"
- Lift arm min./max. spread: 23-7/16" - 27"
- Ram: 4-11/16"
- 40-15/16" L x 42-3/4" W x 35" H
- Weight: 143 lbs



MRI-MTWL

Rechargeable Wheel Lifter for SUV & Light Truck Tires

- Capacity: 187 lbs
- Automatic 3 speed acceleration
- Max. lift height: 48"
- Max. tire diam. x width: 35" x 11"
- Includes:
 - Hardware tray
 - Impact wrench holder
 - Wheel safety strap
 - (2) 12V rechargeable batteries & (1) DC12.6V - 1A charger
- Dim.: 31" L x 29-1/2" W x 64" H
- Weight: 147 lbs



GAI-Y471106 **\$766⁹⁵**

SAFERGO - Truck Tire Dolly

- The easiest way to install and remove truck wheels without having to manually lift wheel sets
- Simply slide the rollers underneath the tire and use the jack handle to raise it to the desired height
- Use the included Gaither O-LINE-ER® to perfectly position the wheel for easy installation
- Lifting capacity: 350 lbs
- Collapsible handle frame



GAI-Y471147HD3

Smart Cart - Truck Wheel & Tire Cart

- When the Smart Cart is pushed toward the stack of tires, the spring-action arms grasp the tires without the need for cumbersome pedals, levers, or gas springs
- Use the push/pull handle to remove the cart from the tire stack
- Accommodates 25" to 33" tires
- Load capacity: 441 lbs



NRC-82306

200 Lbs Capacity Air Operated Tire/Wheel Lift

- Offset design offers open access from the rear to mount wheel to the vehicle
- 6-1/4" low height of support legs
- Lift travel: 39"
- Built-in tray for holding lug nuts
- Overall dim.: 16" L x 17" W x 58" H
- Weight: 210 lbs



MRI-MSTC

Tire Rider Standard Tire Cart

- Handles up to 8 tires
- Max. tire diameter: 29"
- Load capacity: 440 lbs
- Weight: 44 lbs



MRI-MTC

Tire Cart

- Handles up to 8 tires
- Load capacity: 550 lbs
- Weight: 79 lbs



GAI-Y472270

Wheel Assist - Wheel & Tire Lifter and Mover

- Easily lift and move heavy tire/wheel assemblies
- Handles all passenger sizes, including run-flats
- Comes equipped with a loading ramp, sliding tire roller sleeves, and an assist step
- The Wheel Assist travels from floor to post-lift height and is free of hydraulics, pneumatics, and electric components making it virtually maintenance-free
- Lifting capacity: up to 80 lbs without assist, up to 150 lbs with assist



Wheel Assist shown in use

MRI-MSTWD

Truck & Bus Wheel Dolly

- Handles tires between 36" and 48" O.D.
- Load capacity: 275 lbs
- Weight: 22 lbs

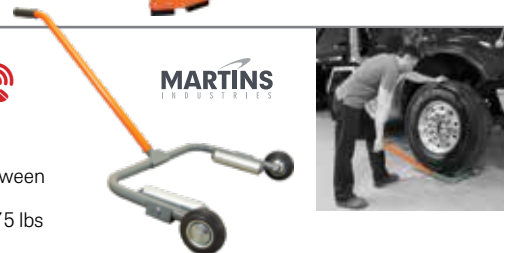

Wheel Dollies / Tire Carts

ATD-7229 **\$206⁶⁵**
300 Lbs Capacity Heavy-Duty Tire & Wheel Cart

- Remove and install truck tire and wheel assemblies
- For 36" to 48" diameter tires



AME-71300 **\$195⁶⁵**
Truck Wheel Dolly

- Accommodates low profile tires
- For 36" to 48" diameter tires

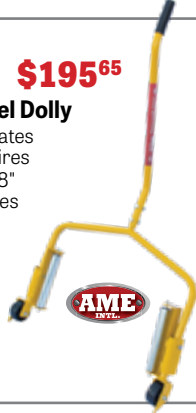

ESC-70132 **\$199⁸⁵**
450 Lbs Capacity HD Super Wheel Dolly

- Designed for super single and flotation tires
- 14" wide rollers accommodate even the largest super single wheels



ESC-70134 **\$286⁴⁵**
330 Lbs Capacity HD Adjustable Wheel Dolly

- Capable of handling a wide range of tires
- For use with 23.5" - 43.5" tires



ESC-90538

Agricultural & Earthmover Wheel Dolly

- Handles large wheels from 49" up to 94.5" diameter, and up to 41.3" in depth
- Lifting capacity: 3,528 lbs • Weight: 350 lbs



Brake Drum Dollies

SUN-1330 **\$659³⁵**
Brake Drum Handler

- Handles 15" and 16.5" outboard mounted brake drums and inboard mounted drums with disc wheel hubs found on most class 7 and 8 tractor and trailer brake systems
- Low height: 10.25" • High lift height: 15.25"
- Weight: 62 lbs



OTC-5090
Back Buddy™ II - Truck Hub and Brake Drum Handler

- Remove and install heavy truck brake drums and hub assemblies • Ratcheting jack with 14" lift
 - Tilting mechanism and fold-down handle
 - Onboard lube tray and toolbox • Weight: 113 lbs
- Included adapters:
- #513926: 10 stud inboard hub & drum assemblies - 335mm
 - #513927: 10 hole outboard drums - 3/4" thick back plates



Cribbing & Safety

Super Stacker Cribbing Blocks

- Non-conducting plastic resists oil and most chemicals
- Does not splinter, like wood
- Working load limit is based on a single-layer application



Item #	Dimensions	Lanyard	Working Load Limit/Block	
AME-15210	4" x 4" x 18"	Yellow - Light	45,194 lbs	\$126.55
AME-15230	6" x 7" x 24"	Blue - Medium	111,010 lbs	\$365.95
AME-15239	6" x 7" x 24"	Orange - Heavy	129,631 lbs	\$404.95

Jack Plates

- Jack plates provide greater stability to bottle jacks and hydraulic rams
- Non-skid surface



Item #	Capacity	Dimensions	
AME-14464	50 Tons	12" x 12" x 1"	\$153.75
AME-14465	100 Tons	12" x 12" x 1.5"	\$226.45
AME-14466	200 Tons	18" x 12" x 3"	\$449.95

AME-15273

8-Pc Super Stacker Cribbing Kit

- Includes:
- (6) #15239
 - (1) #14465
 - (1) #14466

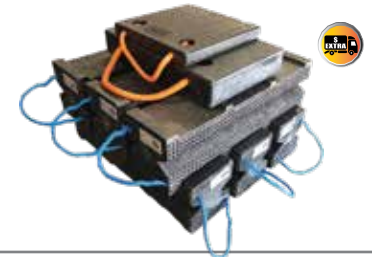

AME-15255

10-Pc FR Industrial Super Stacker Cribbing Kit

- Includes:
- (3) #15210
 - (6) #15230
 - (1) #14465



AME-15300 **\$26⁸⁵**
Rubber Wheel Chock

- Durable rubber construction
- Ribbed pyramid design • Sold individually
- Dimensions (LxWxH): 11.5" x 10" x 7.25"



Lifting Jack Pads

TBQ-4JPT **\$24⁹⁵**
4-Pc Lifting Jack Pads for Tesla Models S, 3, X, Y

- These rubber pads are positioned under the designated Tesla lift points to prevent damage to the battery or the side rails of the vehicle when lifting
- Load capacity (4 pads): 5 ton



CARGO HANDLING / HOISTING EQUIPMENT

Power Pulls

APP-EZ2000 **\$73⁶⁵**
1 Ton Capacity Porta Puller*

- 13:1 leverage • 8 foot pull
- Collapsible handle
- Includes a carrying case
- 25-year warranty

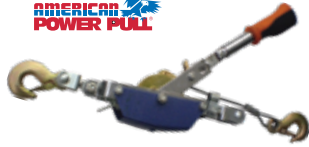

APP-72A **\$109⁴⁵**
2-Ton Power Pull

- 36:1 leverage • 6 foot pull
- Releases load one notch at a time
- Lifetime warranty



ATD-7495 **\$117⁴⁵**
2-Ton Power Puller

- Leverage: 32:1
- Maximum pull: 6 ft.
- Cable: 3/16"
- Releases load one notch at a time



ATD-7496 **\$173³⁵**
4-Ton Power Puller

- Leverage: 34:1
- Maximum pull: 6 ft.
- Cable: 1/4"
- Releases load one notch at a time



Load Binders

Ratchet Load Binders

- 25-year warranty

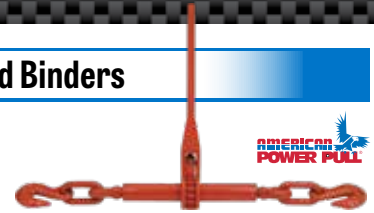

Item #	Size Grade	Take Up	Take Up Working Load Limit	Proof Test Load	Minimum Breaking Strength	
APP-13070	5/16" : 70 3/8" : 40	9-5/16"	5,400 lbs	10,800 lbs	19,000 lbs	\$107.15
APP-13080	3/8" : 70 1/2" : 10	8-5/8"	9,200 lbs	18,400 lbs	33,000 lbs	\$122.25
APP-13085	1/2" : 70 5/8" : 30	8"	13,000 lbs	26,000 lbs	46,000 lbs	\$137.65

Tie-Downs/Binders

ATD-8071 **\$54⁶⁵**
2" x 27" Ratcheting Tie Down with Double J-Hooks

- 10,000 lbs break strength
- 3,333 lbs working load limit



ATD-8072 **\$74⁹⁵**
4-Pc 1" x 15 Ft. Ratcheting Tie Down Set

- Quick automatic release
- 1,500 lbs tie down capacity
- Adjusts from 1 to 15 feet



Chain Hoists/Chain Pullers

400 Series Chain Block Hoists

- Thick steel construction
- Drop forged safety hooks
- Triple geared • Lifetime warranty

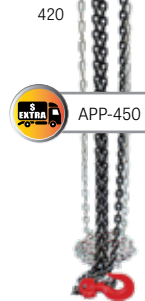

Item #	Rated Capacity	Unit Lift	Load Chain Diameter	
APP-402	1/4 Ton	10 feet	3/16" (4mm)	\$279.35
APP-405	1/2 Ton	10 feet	1/4" (6mm)	\$270.15
APP-410	1 Ton	10 feet	1/4" (6mm)	\$356.75
APP-415	1.5 Ton	10 feet	5/16" (8mm)	\$452.55
APP-420	2 Ton	10 feet	5/16" (8mm)	\$486.95
APP-430	3 Ton	10 feet	5/16" (8mm)	\$583.35
APP-450	5 Ton	10 feet	13/32" (10mm)	\$734.05

600 Series Chain Pullers

- Thick steel construction with drop forged hooks
- Lifetime warranty

Item #	Rated Cap.	Unit Lift	Load Chain Diameter	
APP-602	1/4 Ton	5 feet	3/16" (4mm)	\$221.25
APP-603	1/2 Ton	5 feet	3/16" (4mm)	\$315.05
APP-605	3/4 Ton	5 feet	1/4" (6mm)	\$307.35
APP-610	1 Ton	5 feet	1/4" (6mm)	\$355.95
APP-615	1.5 Ton	5 feet	5/16" (8mm)	\$409.35
APP-635	3 Ton	5 feet	13/32" (10mm)	\$566.85
APP-660	6 Ton	5 feet	13/32" (10mm)	\$1104.15
APP-690	9 Ton	5 feet	13/32" (10mm)	\$2553.35

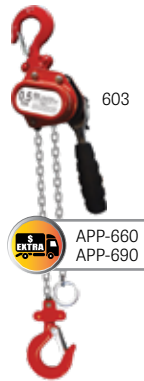

Professional Electric Chain Hoists

- Built-in, multiple-disc, magnetic brake provides positive load holding and spotting
- Adjustable upper and lower limit switches for maximum flexibility in regulating load travel

Item #	Capacity	Lift	Lifting Speed	Chain	Control Cord Length	HP	Voltage (AC)*	Full Load Motor Amps*	Phase
MLW-9560	1/2 Ton	10 Ft.	16 Ft./Minute	Single	6 Ft.	1/2 HP	115V/230V	7.6/3.8	Single
MLW-9561	1/2 Ton	15 Ft.	16 Ft./Minute	Single	11 Ft.	1/2 HP	115V/230V	7.6/3.8	Single
MLW-9562	1/2 Ton	20 Ft.	16 Ft./Minute	Single	16 Ft.	1/2 HP	115V/230V	7.6/3.8	Single
MLW-9565	1 Ton	10 Ft.	16 Ft./Minute	Single	6 Ft.	1 HP	115V/230V	14/7	Single
MLW-9567	1 Ton	15 Ft.	16 Ft./Minute	Single	11 Ft.	1 HP	115V/230V	14/7	Single
MLW-9568	1 Ton	20 Ft.	16 Ft./Minute	Single	16 Ft.	1 HP	115V/230V	14/7	Single
MLW-9570	2 Ton	10 Ft.	8 Ft./Minute	Double	6 Ft.	1 HP	115V/230V	14/7	Single
MLW-9572	2 Ton	15 Ft.	8 Ft./Minute	Double	11 Ft.	1 HP	115V/230V	14/7	Single
MLW-9573	2 Ton	20 Ft.	8 Ft./Minute	Double	16 Ft.	1 HP	115V/230V	14/7	Single

* Refer to the Operator's Manual for specific amperage draw, nominal voltage, electrical requirements and installation by a certified professional.





CHOOSING A WATER PUMP

- **Water transfer pumps:** General-purpose pumps that effectively move water.
- **High pressure pumps:** Greater pressure, but lower volume. Push water greater distances.
- **Chemical pumps:** Move a variety of agriculture and industrial chemicals such as liquid fertilizer.
- **Semi-trash pumps:** For applications with dirty water. Will handle dirt, grit and solids up to 5/8". Tool-less access when the pumps need to be cleaned out.
- **Trash pumps:** Powerful and rugged pumps. Will handle solids up to 1" diameter. Easy access system for opening and cleaning out refuse.



APPLICATION	WATER TRANSFER PUMP	HIGH PRESSURE PUMP	NYLON CHEMICAL PUMP	SEMI-TRASH PUMP	TRASH PUMP
CLEAR WATER	✓	✓	✓	✓	✓
GREY WATER	✓	✓	✓	✓	✓
SEPTIC TANK	✓	✓	✓	✓	✓
SALT WATER		✓	✓	✓	✓
SLIMY WATER			✓	✓	✓
MUCK WATER			✓	✓	✓
MUD WATER			✓	✓	✓
ABRASIVE WATER				✓	✓
SLOW SEEPAGE DITCH WATER				✓	✓
MAN HOLES				✓	✓
BRUSH FIRES		✓			
LIQUID FERTILIZER			✓		
HIGH SOLID CONTENT WATER					✓

Water Transfer Pumps



Water Transfer Pumps



	BEP-WP-1015HT	BEP-WP-2070S	BEP-WP-2065HL	BEP-WP-3065HL	BEP-WP-4013H
Series	WORKSHOP	WORKSHOP	COMMERCIAL	COMMERCIAL	COMMERCIAL
Engine Type / CC	HONDA GX25 / 25CC	POWER EASE R225 / 223CC	HONDA GX200 / 196CC	HONDA GX200 / 196CC	HONDA GX390 / 389CC
Inlet/Outlet Port Size	1"	2"	2"	3"	4"
Flow	36 GPM	158 GPM	158 GPM	264 GPM	430 GPM
Suction Lift / Total Lift	26 ft. / 100 ft.	23 ft. / 82 ft.	26 ft. / 85 ft.	26 ft. / 85 ft.	26 ft. / 115 ft.
Fuel Tank Capacity	0.6L (0.15 GAL)	3.1L (0.82 GAL)	3.1L (0.82 GAL)	3.1L (0.82 GAL)	6.1L (1.6 GAL)
Shipping Dimensions (LxWxH)	16" x 12" x 16"	21" x 17" x 19"	21" x 17" x 19"	21" x 17" x 19"	26" x 18" x 22"
Weight	32 lbs	60 lbs	62 lbs	67 lbs	112 lbs
Warranty (For Manufacture Defects)	2 Years Pump 3 Years Engine	2 Years Pump 2/5 Years Engine	2 Years Pump 3 Years Engine	2 Years Pump 3 Years Engine	2 Years Pump 3 Years Engine
	\$711.35	\$390.65	\$711.35	\$853.85	\$1601.95

Semi-Trash & Trash Pumps

BE

Semi-Trash Pumps & Trash Pumps



	BEP-TP-2065HT	BEP-TP-3070R	BEP-TP-3065HR	BEP-TP-3013HM	BEP-TP-4013HM
Series	COMMERCIAL	WORKSHOP	COMMERCIAL	INDUSTRIAL	INDUSTRIAL
Pump Type	SEMI-TRASH	SEMI-TRASH	SEMI-TRASH	TRASH	TRASH
Engine Type / CC	POWER EASE HONDA GX200 / 196CC	POWER EASE R225 / 223CC	POWER EASE HONDA GX200 / 196CC	POWER EASE HONDA GX390 / 389CC	POWER EASE HONDA GX390 / 389CC
Inlet/Outlet Port Size	2"	3"	3"	3"	4"
Flow	158 GPM	264 GPM	264 GPM	370 GPM	580 GPM
Suction Lift / Total Lift	26 ft. / 85 ft.	26 ft. / 85 ft.	26 ft. / 85 ft.	26 ft. / 98 ft.	26 ft. / 95 ft.
Fuel Tank Capacity	3.1L (0.82 GAL)	3.1L (0.82 GAL)	3.1L (0.82 GAL)	6.1L (1.6 GAL)	6.1L (1.6 GAL)
Capacity for Solids	Up to 5/8"	Up to 5/8"	Up to 5/8"	Up to 1"	Up to 1"
Shipping Dimensions (LxWxH)	21" x 17" x 19"	21" x 17" x 19"	21" x 17" x 19"	26" x 18" x 22"	26" x 18" x 22"
Weight	80 lbs	90 lbs	90 lbs	144 lbs	152 lbs
Warranty (For Manufacture Defects)	2 Years Pump 3 Years Engine	2 Years Pump 2/5 Years Engine	2 Years Pump 2/5 Years Engine	2 Years Pump 3 Years Engine	2 Years Pump 3 Years Engine
	\$1079.45	\$718.45	\$1150.65	\$2611.35	\$2741.95

Chemical Pumps

NP-2070R



Chemical Pumps

NP-3070R



NP-2065HR



NP-3065HR



	BEP-NP-2070R	BEP-NP-3070R	BEP-NP-2065HR	BEP-NP-3065HR
Series	WORKSHOP	WORKSHOP	COMMERCIAL	COMMERCIAL
Engine Type / CC	POWER EASE R225 / 223CC	POWER EASE R225 / 223CC	POWER EASE HONDA GX200 / 196CC	POWER EASE HONDA GX200 / 196CC
Inlet/Outlet Port Size	2"	3"	2"	3"
Flow	154 GPM	265 GPM	154 GPM	265 GPM
Suction Lift / Total Lift	26 ft. / 115 ft.	26 ft. / 92 ft.	26 ft. / 115 ft.	26 ft. / 92 ft.
Fuel Tank Capacity	3.1L (0.82 GAL)	3.1L (0.82 GAL)	3.1L (0.82 GAL)	3.1L (0.82 GAL)
Shipping Dim.(LxWxH)	21" x 17" x 19"	21" x 17" x 19"	21" x 17" x 19"	21" x 17" x 19"
Weight	60 lbs	64 lbs	60 lbs	64 lbs
Warranty (For Manufacture Defects)	2 Years Pump 2/5 Years Engine	2 Years Pump 2/5 Years Engine	2 Years Pump 3 Years Engine	2 Years Pump 3 Years Engine
	\$521.35	\$587.85	\$1067.55	\$1126.95

High Pressure Fire Style Pumps

BEP-HPFK-2070R **\$913¹⁵**

High Pressure Water Pump Kit

- Engine: 225cc • Flow: 126 GPM
- Fuel tank capacity: 3.6L (0.95 gal)
- Inlet/Outlet: 2"
- Suction lift/Total lift: 26/197 ft.
- Kit includes: 50 ft. fire hose, fire hose nozzle, 12 ft. suction hose
- Ship dim.: 28" x 20" x 18" • Weight: 86 lbs
- Warranty: 2/5 yrs Engine/2 yrs Pump



BEP-HPFC-2065HR **\$1435⁶⁵**

Fire Suppression Pump Cart

- Engine: 196cc
- Flow: 126 GPM
- Fuel tank capacity: 3.6L (0.95 gal)
- Inlet/Outlet: 2"
- Suction lift/Total lift: 26/197 ft.
- Kit includes: 12 ft. suction hose with foot valve, 50 ft. fire hose, fire hose nozzle
- Shipping dim.: 30" x 29" x 23"
- Weight: 130 lbs
- Warranty: 3 yrs Engine/2 yrs Pump

\$1388¹⁵

BEP-WS1565H Fire Suppression Pump

- Engine: 196cc
- Flow: 85 GPM
- Fuel tank capacity: 3.6L (0.95 gal)
- 1.5" inlet/outlet • (2) 1" outlets
- Suction lift/Total lift: 26/120 ft.
- Shipping dim.: 27" x 18" x 17"
- Weight: 70 lbs
- Warranty: 3 yrs Engine/2 yrs Pump



Water Transfer Pumps

MLW-2771-20 **\$317⁹⁵**
M18™ Water Transfer Pump (Bare Tool)

- 8 GPM
- Inlet/Outlet: 3/4"
- Max. head height: 75 ft.
- Max. lift height: 18 ft.
- 5-year warranty



Milwaukee

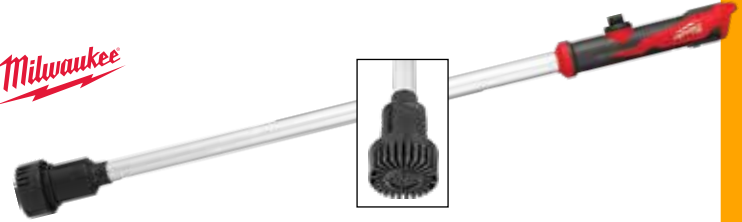

MLW-2579-20 **\$248⁹⁵**

M12™ Stick Transfer Pump (Bare Tool)

- 9 GPM
- 360° filter maximizes flow in heavy debris and shields against clogs
- 3/4" outlet attaches to standard garden hose
- 36" submersible barre



Multi-Fluid Pumps

TURBO XL

DP203

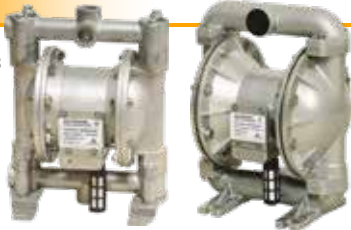

DP201

Diaphragm Pumps

- Nitrile rubber lining
- **Applications:** diesel, unleaded gas, grease, kerosene, all kinds of oils (motor, hydraulic, gear, used oil), antifreeze, windshield washer fluid

Item #	Inlet/Outlet	Max. Flow Rate	
TXL-DP203	3/4"	16 GPM	\$729.65
TXL-DP201	1"	24 GPM	\$886.05

24 GPM Air-Operated Diaphragm Pumps

- O-ring seals and Nitrile diaphragm material
- Heavy duty aluminum construction
- 1" inlet/outlet
- 1/4" air inlet
- **For use with:** diesel, grease, kerosene and oil

DP1

JohnDow Industries

DP1-UL



Item #	Listing	Max. PSI	
JDI-JDI-DP1	Non-UL	115 PSI	\$1083.75
JDI-JDI-DP1-UL	UL	110 PSI	\$2450.45

9CIRCLE®

6L/1.5 Gallon Fluid Extractor Sets

- For use with: motor oil, gear oil, transmission fluid, coolant, brake fluid, power steering fluid, water, etc.
- The #65861 kit comes with a brake bleeder valve adapter for fast brake fluid extraction



Item #	Operation	
9CL-65860	Manual	\$177.15
9CL-65861	Pneumatic	\$218.55

mityvac

FREE!

Buy #MIT-MV7201 and obtain #MIT-MVA7205 for free: Conversion Kit for Brake & Hydraulic Clutch Bleeding.

MIT-MV7201 **\$218⁴⁵**

8.8L Manual Fluid Evacuator/Dispenser

- For use with: motor oil, transmission fluid, coolant, brake fluid
- Can drain engine oil or transmission fluid directly through the dipstick tubes
- Includes:
 - 5.7mm OD x 1.5m dipstick tube
 - 6.6mm OD x 1.5m dipstick tube
 - 10mm OD x 1.5m main evacuation tube
 - Tube adapters



MIT-MV7300 **\$212⁰⁵**

8.8L Air-Operated Fluid Evacuator

- For use with: motor oil, transmission fluid, coolant, brake fluid
- Includes kit #MVA7205 for vacuum bleeding hydraulic brake and clutch systems
- Can drain engine oil or transmission fluid directly through the dipstick tubes
- Includes:
 - 5.7mm OD x 1.5m dipstick tube
 - 6.6mm OD x 1.5m dipstick tube
 - 10mm OD x 1.5m main evacuation tube
 - Tube adapters

mityvac



LMX-LX-1314 **\$367¹⁵**

9.8L Manual/Pneumatic 2-in-1 Fluid Extractor

- For engine & gear oil, brake fluid, transmission fluid, water, etc.
- Automatic overflow prevention
- Decompression valve
- 60" PVC steel braided suction hose
- Dipstick tubes: 3/8" x 17", 3/8" x 30", 1/4" x 31", 5/16" x 36-1/4"
- Tube adapters

LI-MAX



Multi-Fluid Pumps

PBT-71196 **\$219²⁵**
QuickFlow Drill Pump Kit for Most Fluid Types

- Use your cordless drill to pump fluid
- Flow rate of 3L/min with drill speed 1,200 rpm
- One hand operation
- Includes a universal adapter
- Hoses included: (2) 8mm x 1m and (1) 6mm x 1m
- Includes blow mold case



MIT-MV7241 **\$29⁰⁵**
Fluid Transfer Pump

- For engine oil, coolants, transmission fluid, brake fluid or power steering fluid



Hand-Operated Lever Transfer Pumps

- 11 oz per stroke
- 19-3/4" to 35-1/2" telescoping suction pipe



FIL-FR20V **\$157⁸⁵**
Red Pump

- Designed for hydraulic, engine and gear oils, mild acids, degreasers, anti-freeze, coolant



FIL-FRHP32V **\$165⁸⁵**
Blue Pump

- Designed for DEF, AdBlue, hydraulic, engine and gear oils, diesel, anti-freeze, mild acids, and degreasers



SGT-17500 **\$56⁴⁵**

- Pail Pump**
- For use with all non-corrosive liquids including thinner
 - Fits all 5 and 6 gallon pails



LEG-L3300 **\$134⁹⁵**
Rotary Action Barrel Pump

- Dispenses petroleum fuel oils, kerosene or diesel fuel
- Fits 16-55 gallon drums
- Dispenses 10 GPM
- Includes: inlet tube strainer/filter



FIL-SD62 **\$105²⁵**
Standard Duty Rotary Hand Pump

- Compatible with diesel, kerosene, machine oil, fuel oil (not for use with gasoline or corrosive fluids)
- Flow rate: 7.5 gallons (28L) per 100 turns
- Inlet: 3/4"



LEG-L3350 **\$142⁰⁵**
Rotary Action Pump

- Suitable for delivering kerosene, diesel, lubricants, edible oils and other non-corrosive liquids
- Dispenses 14.8 qts. (3.7 gallons) per minute
- Includes: 3/4" x 3 ft. steel suction tube, 4 ft. hose, curved discharge spout and nozzle



SGT-17580 **\$204⁸⁵**
Rotary Barrel Pump

- For use with thinners, acetone, DEF (Urea), gasoline, water, weak acids, windshield washer fluid, anti-freeze, diesel, alkalines and petroleum
- Dispenses 8 gallons per 100 turns
- Fits 15, 30 & 55 gallon drums with 2" bung opening

ATD-5009 **\$147⁰⁵**
Hand Rotary Barrel Pump

- For transferring non-corrosive petroleum-based fluids, light oils, diesel, kerosene (Do not use with water based fluids, solvents, acids, anti-freeze, gasoline)
- Delivers 1.3 gallons per 20 turns
- Fits 16-55 gallon barrels
- Cast iron pump housing



FIL-FR152 **\$334³⁵**
Heavy Duty Piston Hand Pump

- Compatible with gasoline, diesel fuel, light oil and kerosene
- Flow rate: 20 gallons (76L) per 100 strokes
- Inlet/outlet: 1" / 3/4"
- 3/4" x 8 ft. hose
- UL/cUL certified



ATD-5025 **\$456⁹⁵**
Double Diaphragm Fuel Transfer Pump

- For use with gasoline, diesel fuel, fuel oil, motor oil and petroleum based media of light to medium viscosity (Do not use with corrosive liquids, solvents, acids, alkalis, etc.)
- Dispenses 1 gallon in 5 strokes
- Fits 15 to 55 gallon drums
- 2" Bung adapter
- 8 ft. anti-static neoprene rubber hose
- Heavy duty aluminum die-cast construction



Multi-Fluid Pumps



ATD-5024 **\$71⁹⁵**



Ezee Flo Pump

- For use with engine oil, gear oil, kerosene, diesel, light fuel, oil-based paint thinners
- Delivers 1 quart per 15 strokes
- Use with 5 gallon containers
- 4 ft. vinyl hose with steel discharge spout
- Includes 3/4" pump extender for use on high depth containers

SGT-17550 **\$80⁶⁵**



Drum Pump

- Use to transfer petroleum based fluids such as lubricants, anti-freeze, solvents, thinner and other non-corrosive liquids
- Delivers 1.5 pints (710 ml) per stroke
- Fits 15, 30 and 55 gallon drums
- Bung adapter fits all standard drums



ATD-5062 **\$284⁵⁵**

Stainless Steel Vertical Lift Pump

- For use with photographic chemicals/solvents, diesel, kerosene, thinners, acetone, benzene, naptha, urea, DEF, AdBlue®, light oil (up to SAE 40)
- Flow rate: up to 25 oz. (750 ml) per stroke
- For use with 55 gallon drums
- 2" Bung adapter • Flow control tube
- Built-in lock nut for attaching grounding wires

LMX-LX-1316 **\$72¹⁵**



Heavy Duty Lever Action Pump

- For non-corrosive fluids such as: heating oil, motor oil, transmission fluid, automotive additives (oil based), oils (light and heavy), soaps, etc. (Not recommended for use with: acids, anti-freeze, detergent and soap solutions, gasoline, juices, lacquer solvents, corrosive chemicals, vegetable oils or water-based media)
- Delivers 13 oz per stroke
- Fits 15-55 gallon drums with standard 2" bung
- 34" self-adjusting telescopic tube
- 1-1/2" & 2" bung bushing • Inlet: 1-1/4" • Outlet: 3/4"



SGT-17560 **\$79³⁵**



Lever Barrel Pump

- For use with petroleum based non-corrosive fluids
- Dispenses approx. 10 oz. per stroke
- Fits 15 - 55 gallon drums
- Telescopic tube adjusts from 19" to 35"



LIN-1340 **\$86⁵⁵**

Lever Action Barrel Pump

- For use with non-corrosive fluids, motor oil, transmission fluid, gear oil, engine coolant, silicone oils, and more (not suitable for gasoline)
- Pumps a minimum of 14.0 fl oz. (414 ml) per stroke
- Fits 16-55 gallon drums



ATD-5007 **\$94²⁵**

Heavy Duty Barrel Pump

- For use with: oil based fluids, motor oils, heavy & light oils, diesel, kerosene, heating oils
- Delivers 10 oz. of fluid per stroke
- Fits 16-55 gallon drums
- Standard 1-1/2" and 2" bung adapter



JDI-JDI-DEF-LP **\$59⁷⁵**



DEF Lever Pump

- Also compatible with: water, diesel, biodiesel, kerosene, oil, weak acid and weak alkali
- Anti-corrosion
- Adjustable 36" downtube
- Fits 5 to 55 gallon drums



LMX-LX-1329 **\$108⁷⁵**



Premium Lever Action Chemical Pump

- For acidic solutions, chemicals, fuels, fuel oils, DEF, Urea, AdBlue®
- Delivers 1 gallon per 8 strokes
- Fits 15-55 gallon drums
- Adjustable locking ring rotates 360°
- Non-drip spout



ATD-5080 **\$191¹⁵**

Plastic Lever Action Barrel Pump

- For use with water-based media, detergents, soaps, antifreeze, windshield washer, hydraulic oils, lubricants, herbicides & pesticides, AdBlue, Urea, DEF
- Delivers 1 pint (500 ml) per stroke
- Fits 15-55 gallon drums
- 6.5 ft. x 3/4" discharge hose
- Built-in 2" bung adapter



Drum Wrenches

LIN-5841 **\$22⁹⁵**



Drum Plug Wrench

- For loosening and tightening plugs and caps
- Compatible with standard metal and plastic caps or plugs on 16-gallon and 55-gallon drums



ATD-5271 **\$36²⁵**



Non-Sparking Aluminum Drum Plug Wrench

- Opens most 2" and 3/4" drum plugs



Drum Dollies

5216

5255



Drum Dollies

- 11 gauge steel

Item #	Container Capacity	Base Diameter	Max. Load Capacity	
ATD-5216	16-Gallon	13" - 14.25"	200 lbs	\$93.45
ATD-5255	55-Gallon	23"	1,200 lbs	\$262.35

Fluid Refilling Systems



Fluid Evacuation and Refill Reservoirs

- Utilizes compressed "shop-air" for dispensing and extracting
- Isolated flow control valve and pressure/vacuum switch
- Includes combination pressure/vacuum gauge
- Lid is interchangeable with other reservoir sizes

Item #	Capacity	Included Accessories	
MIT-MV7102	2.5 Quart (2.5L)	Flex hose with control valve and 12" evacuation wand	\$342.35
MIT-MV7105	1.2 Gallon (5L)	Flex hose with control valve and 12" evacuation wand	\$368.95
MIT-MV7110	2.5 Gallon (10L)	Flex hose with control valve and 12", 61.5", 97.5" evacuation wands	\$363.95
MIT-MV7120	5.3 Gallon (20L)	Flex hose with control valve and 12", 61.5", 97.5" evacuation wands	\$400.55

MIT-MV6412A **\$559²⁵**

2.5-Gallon (10L) Automatic Transmission Fluid Refill System

- Includes a kit of 10 adapters (#MIT-MVA5800) to connect to Ford, Toyota, BMW, Honda, Nissan, VW, Audi, Mercedes, and Volvo transmissions

FREE!

Buy #MIT-MV6412A and obtain #MIT-MVA6851 for free: 7 oz. Fluid Extractor/Dispenser.



MIT-MV7412 **\$567⁶⁵**

2.5 Gallon (10L) Automatic Transmission Fluid Refill & Evacuation Kit

- Utilizes compressed "shop-air" for dispensing and extracting
- Includes a kit of 13 adapters to connect to various transmissions (#MIT-MVA5800A)
- Isolated flow control valve and pressure/vacuum switch



CTA-7400 **\$361⁶⁵**

9L Capacity ATF Filling System

- Works on most makes & models
- 5 ft. clear dispensing hose
- 0 - 35 PSI (0 - 2.5 bar) gauge
- Compatible with other brands of adapters



9CIRCLE[®]

9CL-65801 **\$546⁶⁵**

12.5L Capacity Fluid Refilling System Kit

- Used for ATF, gear oil, and differential refilling
- Pneumatic or manual refilling
- Includes 10 adapters for most popular vehicles: Audi, Ford, Mercedes, Toyota, Volkswagen and Volvo



9CIRCLE[®]

9CL-65820 **\$367⁹⁵**

6L Capacity Manual ATF Refilling System

- Refills automatic transmissions without a dipstick
- For most transmissions: Audi, Cadillac, Ford, GMC, Infiniti, Mercedes, Nissan, Toyota, VW, and Volvo
- Tank base designed for feet to step on to stabilize the tank while pumping



9CIRCLE[®]

9CL-65821 **\$141⁴⁵**

20-Pc ATF Refilling Adapters Kit

- For filling automatic transmissions without no dipstick
- Suitable for Audi, Cadillac, Chevrolet, Ford, Honda, Hyundai, Infiniti, Mercedes, Nissan, Toyota, Volkswagen, and Volvo



CTA-3950 **\$425⁹⁵**

19-Pc Master ATF Filler Adapter Set

- For use with #CTA-7400, plus other brands of tanks

Fluid Refilling Systems



ASM-ATFBASIC **\$281⁶⁵** 8L Capacity Basic Drive Line Filler

- Used for filling fluids in transmissions, differentials and transfer cases (not suitable for use with fuels or solvents)



ASM-ATF129 **\$70⁰⁵** Mercedes-Benz 722.9 Transmission Filling Adapter

- M12 x 1.5



ASM-ATF16DSG **\$68⁹⁵** VW/Audi "DSG" Transmission Filling Adapter

- M24 x 1.5
- Comparable to VW/Audi #VAS6262A



ASM-ATF19ST **\$67⁶⁵** Audi Steptronic Transmission Filling Adapter

- For 2018-2019 Audi A4, A6, and Q5
- Comparable to factory tool #VAS6617/12



ASM-ATF61GM **\$46⁵⁵** GM Transmission Filling Adapter, M6 x 1

- Applicable to GM 8L45, 8L90 and 10L90 transmissions (2015-2018)
- Comparable to factory tool #DT-51190

CTA-7430 **\$42⁰⁵**

VW/Audi S Tronic ATF Filler Adapter

- For 2018-2020 Audi A4, A6, and Q5
- Will work on most "Non-CTA" ATF Filling System Tanks



OTC-6604 **\$32⁸⁵**

Transmission Fluid Filling Adapter for 2003+ Ford Explorer

- For the 5R55W automatic transmission used on 2003-newer Ford Explorers
- Same as Ford No. 307-437



9CL-65820-21 **\$22⁰⁵**

Audi ATF Fluid Refilling Adapter for 7-Speed

- Adapter for refilling ATF on automatic transmissions without a dipstick
- Twist type for Audi 7-speed dual-clutch transmissions
- Can be used with 9CL-65801 and 9CL-65820 tank
- Compatible with other tanks on the market



9CL-65830 **\$75⁷⁵** ATF Drain & Refill Set for Mercedes 9G-Tronic 725.0 Transmissions



Fluid Extractors/Dispensers

CTA-7077 **\$99⁴⁵** 1.5L Fluid Extractor/Filling Pump

- For all automotive fluids except fuels

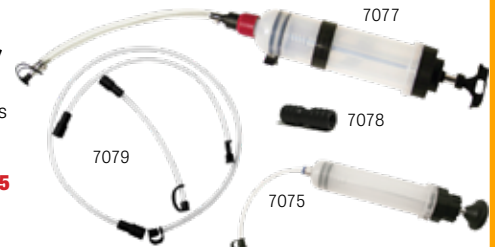

CTA-7074 **\$173⁵⁵** Fluid Extractor/Filling Pump Kit

- Includes: 1.5L (7077) & 200ml (7075) pumps, ATF filling adapter (7078), 3-piece hose extension kit (7079)
- For all automotive fluids except fuels



CTA-7073 **\$50⁹⁵** 200ml Extractor/Filling Pump with Extra Hose



MVA6852



Fluid Extractor/Dispenser

- #MVA6852 includes an automatic transmission fluid adapter

Item #	Capacity	
MIT-MVA6852	1.5 L (50 oz.)	\$91.05
MIT-MVA6851	207ml (7 oz)	\$48.55

MIT-MVA6853 **\$126⁰⁵** 1.5L Fuel & Fluid Extractor/Primer/Dispenser

- Comes with adapters for diesel fuel and is compatible with other Mityvac connectors
- Applications: diesel fuel, gas, motor oil, brake fluid, transmission fluid, rear differential fluid, coolant



LIN-617 **\$86⁰⁵** 1.5-Liter DEF Fluid Extractor/Dispenser



LEG-L1700 **\$34³⁵** 16 oz. Suction Gun



ATD-5004 **\$32⁴⁵** Suction Gun for Non-Corrosive Lubricants

- 16 oz. capacity



ATD-5040 **\$53⁰⁵** Dual-Action Fluid Transfer Gun

- Use with fuel, oil, antifreeze, brake fluid and spirits
- 4 ft. hose for each valve

Gas/Diesel Pumps & Accessories

FILL-RITE
A GOSNOWN-WOFF COMPANY



NEW



Heavy Duty Fuel Transfer Pumps (Pump Only)

- Compatible with: Gasoline, Diesel, B20, E15 (E10 for #FR8-PX) and Kerosene
- Cast iron housing
- UL/cUL certified motor

Item #	Voltage	Flow	Inlet/Outlet	Motor	
FIL-FR8-PX	12V DC	8 GPM (30 LPM)	1" / 3/4"	1/12 HP	\$368.45
FIL-FR604H	115V AC	15 GPM (57 LPM)	1" / 3/4"	1/6 HP	\$628.65
FIL-FR4204H	12V DC	20 GPM (76 LPM)	1" / 1"	1/4 HP	\$616.85



FR8 Series

NEW



Heavy Duty Fuel Transfer Pump Kits

- Compatible with: Gasoline, Diesel, B20, E15 (E10 for #FR8) Kerosene
- Cast iron housing construction
- UL/cUL certified motor

Item #	Voltage	Flow GMP / LPM	Inlet/Outlet	Motor	Nozzle	Hose	Telescoping Suction Pipe	
FIL-FR8	12V DC	8 / 30	1" / 3/4"	1/12 HP	Manual – 3/4"	3/4" x 12 ft.	13-13/16" to 37"	\$546.95
FIL-FR1210H	12V DC	15 / 57	1" / 3/4"	1/4 HP	Manual – 3/4"	3/4" x 12 ft.	20" to 34-3/4"	\$650.95
FIL-FR700V	115V AC	20 / 76	1-1/4" / 3/4"	1/3 HP	Manual – 3/4"	3/4" x 12 ft.		\$1071.75
FIL-FR4210H	12V DC	20 / 76	1" / 1"	1/4 HP	Manual – 1"	1" x 12 ft.	20" to 34-3/4"	\$807.75

FILL-RITE
A GOSNOWN-WOFF COMPANY



Arctic Duty 12V DC Fuel Pumps Kits

- Compatible with: Gasoline, Diesel, B20, E15 and Kerosene
- Temperature rating: -20°F / -29°C
- Arctic duty automatic nozzle with diesel spout
- Arctic duty swivel
- Cast iron construction
- UL/cUL certified

ARCTIC DUTY SERIES

Item #	Voltage	Flow	Inlet/Outlet	Motor	Hose	Telescoping Suction Pipe	
FIL-FR1210HARC	12V DC	15 GPM (57 LPM)	1" / 3/4"	1/4 HP	3/4" x 15 ft. Arctic Hose	20" to 34-3/4"	\$967.85
FIL-FR4210HARC	12V DC	20 GPM (76 LPM)	1" / 3/4"	1/4 HP	1" x 20 ft. Arctic Hose	20" to 34-1/2"	\$1448.95

Portable 12V DC Standard Duty Transfer Pumps

- Compatible with Diesel and Antifreeze
- 10 GPM (38 LPM)
- 1/5 HP motor, 17 Amps
- Inlet/Outlet: 3/4" NPT
- Cast iron body



FIL-FR1612 Pump Only

\$240⁷⁵



FIL-FR1614 Pump Kit

\$309⁵⁵

- Plastic nozzle
- 8 ft. PVC suction and discharge hoses

Gas/Diesel Pumps & Accessories



RD812NH



RD1212NP



RD812NN
RD1212NN

Portable 12V DC Fuel Transfer Pumps

- Compatible with: Gasoline, Diesel, B20, E15 and Kerosene
- 3/4" inlet/outlet
- 10 ft. power cord with alligator clips
- Aluminum construction
- UL/cUL certified motor

Item #	Content	Flow	Motor	Discharge Hose	Suction Hose	Suction Tube	
FIL-RD812NH	Pump, Hose, Manual Nozzle	8 GPM (30 LPM)	1/6 HP	8 ft.	6 ft.		\$508.45
FIL-RD1212NP	Pump, Hose, Manual Nozzle and Bung Mount Adapter	12 GPM (45 LPM)	1/6 HP	8 ft.		Telescoping 23" to 41"	\$683.35
FIL-RD812NN	Pump Only	8 GPM (30 LPM)	1/6 HP				\$436.15
FIL-RD1212NN	Pump Only	12 GPM (45 LPM)	1/6 HP				\$552.75



Aluminum Manual Nozzles

- Compatible with: Gasoline and Diesel
- Operates to -20°F (-29°C)
- UL/cUL listed

Item #	Nozzle	Output	Max. Flow	
FIL-FRHMN075S	3/4"	3/4"	20 GPM (76 LPM)	\$66.05
FIL-FRHMN100S	1"	1"	20 GPM (76 LPM)	\$66.05



FRHMN075S
FRHMN100S

Arctic Duty Automatic Nozzles

- Compatible with Diesel
- Operates to -40°F (-40°C)
- Insulated hand grip
- UL/cUL listed

ARCTIC DUTY SERIES				
Item #	Nozzle	Output	Max. Flow	
FIL-FRNA075DAU10	3/4"	3/4"	2.5-14.5 GPM (9.5-55 LPM)	\$248.05
FIL-FRNA100DAU00	1"	1"	5-25 GPM (19-95 LPM)	\$440.65



FRNA075DAU10
FRNA100DAU00



N100DAU12



N100DAU12G



N075UAU10



N075DAU10

Automatic Nozzles

- Operates to -20°F (-29°C)
- UL/cUL listed

Item #	Colour	Compatible with	Nozzle	Output	Max. Flow	
FIL-N100DAU12	Red	Gasoline, Diesel, E15, B20, Kerosene	1"	1"	5-25 GPM (19-95 LPM)	\$237.55
FIL-N100DAU12G	Green	Gasoline, Diesel, E15, B20, Kerosene	1"	1"	5-25 GPM (19-95 LPM)	\$237.55
FIL-N075UAU10	Red	Unleaded Fuel	3/4" O.D.	3/4"	2.5-14.5 GPM (9.5-55 LPM)	\$171.15
FIL-N075DAU10	Green	Diesel	3/4"	3/4"	2.5-14.5 GPM (9.5-55 LPM)	\$171.15



N100DAU13



N100DAU13G



N100DAU13Y

Ultra Hi-Flow Automatic Nozzles

- Compatible with: Gasoline, Diesel, E15, B20 and Kerosene
- Operates to -20°F (-29°C)
- Insulated hand grip
- UL/cUL listed

Item #	Colour	Nozzle	Output	Max. Flow	
FIL-N100DAU13	Red	1"	1"	5-40 GPM (19-150 LPM)	\$333.55
FIL-N100DAU13G	Green	1"	1"	5-40 GPM (19-150 LPM)	\$333.55
FIL-N100DAU13Y	Yellow	1"	1"	5-40 GPM (19-150 LPM)	\$333.55

Gas/Diesel Pumps & Accessories



3-Digit Mechanical Meters

- For Gasoline, Diesel, B20, E15, Kerosene
- Flow rate: 5-20 GPM/19-75 LPM
- +/- 1% accuracy rating
- #807CLMK includes fittings to mount on FR1200, FR2400, FR600, SD600, SD1200, and FR700V series pumps

Item #	Desc.	Inlet/Outlet	
FIL-807C	Gallon	3/4"	\$337.05
FIL-807C1	Gallon	1"	\$345.15
FIL-807CL	Liter	3/4"	\$329.55
FIL-807CLMK	Liter	3/4"	\$378.95
FIL-807CL1	Liter	1"	\$335.55



807C
807C1
807CL
807CL1



807CLMK

In-Line Digital Turbine Meters

- Flow rate: 2-35 GPM (8-132 LPM)
- 1" NPT inlet/outlet
- Measures ounces, gallons, liters, quarts, pints



TT10AN/TT10ANC

TT10PN

Item #	Compatible with	
FIL-TT10AN	Gasoline, Diesel, Jet Fuel, Heptane, Kerosene, Mineral Spirits	\$329.35
FIL-TT10ANC	E85, B100 Biodiesel, Gasoline, Diesel, Jet Fuel, Non-Potable Water, Lavatory Water, Mineral Spirits	\$348.65
FIL-TT10PN	DEF/AdBlue®, Anti-Freeze, De-Icing Fluid, Non-Potable Water, and Other Chemicals	\$348.65



F4030PMO

F2510PMO

F2510HMO



1200KTF7018

1200KTF7019

Spin-On Filters and Filter Kits, 50 PSI

- Suitable for all electric pumps
- Compatible with gasoline and diesel/ULSD (#F2510PMO also compatible with Ethanol up to 25%)

Item #	Type	Cap.	Mic-rons	Filter Thread	Dim.	
FIL-F4030PMO	Particulate	40 GPM (151 LPM)	30	1.5"-16 UNF	W. 5.1" L. 10.9"	\$64.25
FIL-F2510PMO	Particulate	25 GPM (94 LPM)	10	1"-12 UNF	W. 3.8" L. 5.4"	\$26.75
FIL-F2510HMO	Hydrosorb®	25 GPM (94 LPM)	10	1"-12 UNF	W. 3.8" L. 5.4"	\$32.15
FIL-1200KTF7018	Particulate 3/4" NPT Kit	25 GPM (94 LPM)	10	1"-12 UNF	W. 3.8" L. 8.8"	\$86.15
FIL-1210KTF7019	Hydrosorb® 3/4" NPT Kit	25 GPM (94 LPM)	10	1"-12 UNF	W. 3.8" L. 8.8"	\$96.45

Fuel Transfer Hoses

- For Gasoline, Diesel, B20, E15, Kerosene
- Internal spring guard
- Stainless steel ground wire
- Suitable for all electric pumps
- Arctic Duty hoses rate to -40°F/-40°C



Item #	Size x Length	
FIL-FRH07512	3/4" x 12 feet	\$57.15
FIL-FRH07514	3/4" x 14 feet	\$69.65
FIL-FRH07520	3/4" x 20 feet	\$85.65
FIL-FRH10020	1" x 20 feet	\$112.45



ARCTIC DUTY Fuel Hoses

Item #	Size x Length	
FIL-ARCH07520A	3/4" x 20 feet	\$176.45
FIL-ARCH10020A	1" x 20 feet	\$314.35

FIL-1200KTG9099 **\$55³⁵**

1" Telescoping Steel Suction Pipe

- Extends from 20" to 34-1/2"



FIL-700ACCF7017 **\$85⁶⁵**

1" Aluminum Filter Head



Non-Reconnectable Breakaway Valves

- Instant closing poppet check valve
- Compatible with gasoline, diesel, E15 & biodiesel up to B20
- UL/cUL



Item #	Inlet/Outlet	
FIL-B075F350	3/4" FNPT	\$96.45
FIL-B100F475	1" FNPT	\$207.85



FRTC

FRTCB

FIL-FRTC **\$46⁸⁵**

Tank Vent Cap

- Hole and tab for padlock security

FIL-FRTCB **\$73²⁵**

Tank Vent Cap with Base

- Fits standard 2" NPT threaded bung
- Cast iron base
- Hole and tab for padlock security



Multi-Plane Swivels

- Full 360° spherical rotation for easy movement of the nozzle
- Operates to -40°F (-40°C)

Item #	Size	
FIL-S075H1314	3/4"	\$89.25
FIL-S100H1315	1"	\$142.85

MUK-515 007/V2 **\$332⁹⁵**

Universal Diesel Filter Filler

- For all diesel vehicle filter changing as well as removing air from the system
- Can also be used in diesel injection engines in European cars



Fuel Storage & Transfer Caddies



Low-Profile Carrytanks

- Fits easily in the back of a pickup truck below the truck bed sides
- Rugged polyethylene construction • 12V transfer pump • 10 GPM
- Automatic dispensing nozzle with removable drip tray
- Integrated forklift pockets
- Integrated recesses for ratchet straps • Protective and lockable cover
- Internal baffle prevents sloshing during transport (JDI-AGT40 only)

Item #	Designation	Capacity	Dimensions	Weight
JDI-JDI-AFT58LP	Diesel	58 Gal	45" x 31" x 17.7"	56 lbs
JDI-JDI-AGT40	Gasoline	40 Gal	38" x 23" x 18"	66 lbs
JDI-JDI-DEF40	DEF	40 Gal	38" x 23" x 18"	66 lbs



JDI-FC-25PFC **\$715⁶⁵** 25-Gallon Polyethylene Fuel Cart

- Transport Canada approved
- For storing and transferring fuel
- "Lay flat" design
- 2 GPM – gravity flow
- 10 ft. dispensing hose

25-Gallon UL Listed Steel Caddies

- For use with: diesel, kerosene, bio-diesel, transmission fluid
- 8 ft. PVC suction/discharge hose with internal steel grounding wire
- Tank ground wire & clamp
- Decal set for contents identification
- 21" W x 13" L x 46" H

Item #	Designation	Price
JDI-FC-25GC	Red – Gas	\$1212.25
JDI-FC-25DC	Yellow – Diesel	\$1212.25



ATD-2025 **\$986¹⁵** 25-Gallon Gas Caddy

- For use with gasoline, kerosene, diesel or mixed fuels
- Heavy-duty cast iron pump with carbon vanes
- Two-way pump operation for siphoning or dispensing
- Pump 1 gallon for every 12 revolutions
- 8 ft. discharge hose
- Ground wire and clamp
- Complies with OSHA guidelines
- 25" x 21" x 47-1/4" • Weight: 88 lbs



FC-P30A-UL-D



FC-P30-UL

30-Gallon UL Listed Steel Caddies

- For use with: gasoline, diesel, kerosene, bio-diesel, transmission fluid
- 10 micron internal filter • Decal set for contents identification
- 8 ft. PVC suction/discharge hose • Ground wire & clamp

Item #	Designation	Pump	Colour
JDI-FC-P30A-UL	Gas	Air-Operated	Red
JDI-FC-P30A-UL-D	Diesel	Air-Operated	Yellow
JDI-FC-P30-UL	Gas	Manual	Red
JDI-FC-P30-UL-D	Diesel	Manual	Yellow



JDI-JDI-FST15 15-Gallon Portable Fuel Station

- UN/DOT approved
- 10 ft. dispensing hose
- Built-in shut off valve
- Ground wire for safety
- Weight: 29 lbs
- Gross weight filled: 116 lbs
- Dim.: 38.3" x 11.15" x 15.9"
- Use with one type of fuel only



Static Discharge/Grounding Reels



G 3050



GHC3100 N

Heavy Duty Static Discharge/Grounding Reels

- 100 Amp clamp rating
- Used to ground equipment operating in hazardous atmospheres
- Dissipates static electrical buildup, reducing the chances of sparking and the potential of explosion

Item #	Cable Length	Cable Size	Rewind Method	Price
RFT-G 3050	50 ft.	3/32" O.D. Steel Aircraft Cable	Spring Driven	\$531.05
RFT-GHC3100 N	100 ft.	1/8" O.D. Hi-Vis Orange Nylon Covered Cable	Hand Crank	\$547.75

Manual Grease Guns

AST-101 **\$19⁰⁵**
Mini 3 oz Grease Gun



Astro



LIN-G110 **\$24⁸⁵**
Mini Pistol Grip
3 oz Grease Gun

- 4" rigid pipe extension and coupler



LIN-1154 **\$67⁴⁵**
Dual-Piston Lever-Action
Grease Gun

- Grease gun switches between high-pressure mode and high-volume mode with the press of a thumb
- High-pressure: 1 oz (28 g) per 38 strokes, 10,000 PSI
- High-volume: 1 oz (28 g) per 12 strokes, 3,000 PSI



Heavy-Duty Manual Grease Guns

- Lube capacity: 16oz. bulk/14.5oz. cartridge
- Coupler included

Item #	Pressure	Extension	
LIN-1133	6,000 psi	18" hose	\$69.65
LIN-1134	7,500 psi	18" hose, 6" pipe	\$78.95
LIN-1142	10,000 psi	6" pipe	\$45.15
LIN-1147	6,000 psi	18" hose	\$60.25

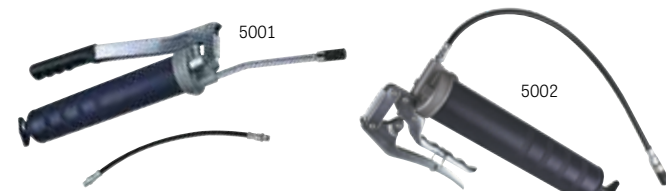

Manual Grease Guns

- 6" steel extension with 4-jaw coupler
- For use with 14 oz. grease cartridge

Item #	Style	Extension	Hose	PSI	
ATD-5001	Lever	6" Rigid	12"	10,000	\$60.75
ATD-5002	Pistol	6" Rigid	18"	5,500	\$62.35



LIN-G100 **\$22⁶⁵**
Lever Action
Manual Grease Gun

- Uses 14 oz. grease cartridge
- Heavy duty steel barrel with corrosion-resistant finish



LIN-G113 **\$38⁴⁵**
Heavy Duty Pistol Grip
Manual Grease Gun

- Uses 14 oz. cartridge or can be bulk filled
- 18" flex hose extension and coupler
- Heavy duty steel barrel with corrosion-resistant finish



Professional Grease Guns

- 3-jaw locking coupler
- For use with 14 oz. grease cartridge

Item #	Style	Extension	Hose	PSI	
OTC-2300	Lever	6" bent	24"	10,000	\$75.75
OTC-2304	Pistol	4" straight	24"	7,500	\$90.95



LEG-L1325 **\$54⁸⁵**
Workforce® Pro Heavy-Duty
Pistol Grip Grease Gun

- 4-jaw coupler
- 12" flexible grease hose
- 6" straight extension



Battery-Operated Grease Guns



PowerLuber Rechargeable Grease Guns

Item #	Battery	Charger	Pressure	
LIN-1884	(2) 20V Li-Ion (#1871) • 36" hose • Multi-function LCD Display shows grease output, battery charge, blocked fittings, loss of prime	(1) 110V (#1870)	10,000 psi	\$602.15
LIN-1888	(2) 20V Li-Ion (#1871) • 2-speed: 3.5 oz / 10 oz per min. • 48" hose • LED indicators identify grease output, battery charge, blocked fittings, loss of prime	(1) 110V (#1870)	10,000 psi	\$573.15



FREE!

Buy #LIN-1884 and obtain #LIN-1871 for free: 20V Li-Ion PowerLuber Battery.



2646-22CT



M18™ 18V 2-Speed Grease Gun

- 48" flex hose
- 10,000 psi



2646-20

Item #	Batteries	Charger	
MLW-2646-22CT	(2) M18™ 18V	(1) Multi-Voltage	\$416.55
MLW-2646-21CT	(1) M18™ 18V	(1) Multi-Voltage	\$397.95
MLW-2646-20	— Bare Tool —		\$277.95

MLW-2446-20 **\$207⁹⁵**
M12™ Cordless Lithium-Ion Grease Gun (Bare Tool)

- 36" flex hose
- 8,000 psi



DEW-DCGG571M1 **\$343⁸⁵**
20V MAX* Lithium-Ion Grease Gun Kit

- Variable speed trigger
- 42" hose
- 10,000 psi • 5 oz/minute
- LED work light
- 20V MAX XR 4.0 Ah li-ion battery & fast charger



DEW-DCGG571B **\$285⁷⁵**
20V MAX* Grease Gun (Bare Tool)

Air-Operated Grease Guns



OTC-2310 **\$151⁵⁵**
Air Operated Grease Gun - Continuous Flow

- 3-jaw locking coupler
- 6" bent steel extension
- 24" high pressure hose
- 4,800 psi



LIN-1162 **\$161⁴⁵**
PowerLuber® Fully Automatic Pneumatic Grease Gun

- Pump ratio 40:1 at 150 psi
- Max. grease pressure 6,000 psi
- Lube capacity 16 oz. bulk / 14.5 oz. cartridge
- 30" high-pressure hose with coupler



Grease Accessories

AST-9430 **\$82⁷⁵** Grease Fitting Adapter Set

- Press-on 90° angle adapter
- Slide-on 90° adapter
- 360° adapter
- Straight adapter
- Rubber tipped adapter
- Needle adapter
- 12" hose extension



LIN-58000 **\$179⁵⁵** 7-Pc Heavy-Duty Grease Adapter Kit

- Quick-connect
- Use with all standard grease guns and dispensing devices



Legacy **Workforce**



Workforce® Grease Couplers

Item #	Grease Coupler Features	
LEG-L2010	Workforce® Grease Coupler, 4-Jaw, Ball Check For use on air or manual equipment	\$5.85
LEG-L2100-1	Workforce® Grease Coupler, Needle-Point, Hypodermic Type – For manual guns only	\$6.65

LINCOLN



Lincoln® Grease Accessories

Item #	Description	
LIN-5803	Needle Nozzle 1/8" NPT (f) thread	\$15.55
LIN-5806	6" Long Needle Nozzle 1/8" NPT (f) thread	\$32.45
LIN-5845	Heavy-Duty Grease Coupler 7,500 psi • 1/8 in. NPT (f)	\$20.35
LIN-5849	Quick-Connect Grease Coupler with Locking Sleeve & 360° Swivel • Max. 7500 PSI	\$85.45
LIN-5859	Quick-Connect Locking Sleeve Grease Coupler with 90° End	\$46.15
LIN-5852	Hydraulic Grease Coupler 6,000 psi • 1/8 in. NPT (f)	\$7.05
LIN-5884	Quick-Connect Locking Sleeve Grease Coupler with 90° Special Access Coupler	\$27.85
LIN-81387	Universal High Pressure Swivel • 1/2"-27 (m) x 1/4" NPT(m)	\$120.25

PowerLuber® Whip Hoses

- 1/8" MNPT fittings
- Working pressure 7,500 psi

Item #	Length	
LIN-1230	30"	\$57.95
LIN-1236	36"	\$62.65



Grease Hoses for Manual or Air-Operated Grease Guns

- 1/8" MNPT fittings
- Working pressure: 4,500 psi

Item #	Length	
LIN-5818	18"	\$29.05
LIN-5861	36"	\$63.95



Grease Whip Hoses

- 4,500 PSI working pressure
- 1/8" MNPT
- For use on hand operated grease guns only

Item #	Length	
ATD-8202	12"	\$12.65
ATD-8203	18"	\$14.55



LIN-5900 **\$49⁶⁵** PowerLock Coupler

- Secure attachment enables single-handed use of grease gun



LIN-740 **\$210⁰⁵** Heavy-Duty High-Pressure Grease Gun with Control Valve

- 7,500 psi • Inlet 1/4" NPT(f); Outlet 1/8" NPT(f)



ATD-5218 **\$129⁷⁵** High Pressure Control Valve for Grease

- Operating pressure: 7,500 psi • 6" extension tube

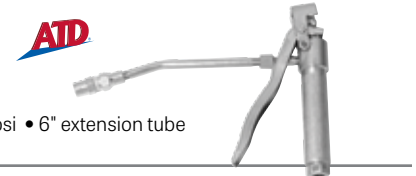

Heavy-Duty Quick-Release Grease Couplers

- Working pressure: 15,000 psi
- For use on most and bulk grease pumps

Item #	Length	
LMX-LX-1403	2.9"	\$40.25
LMX-LX-1403-XL	5"	\$62.65



IPA-7862 **\$78⁰⁵** Grease Joint Rejuvenator® Professional Model

- Instantly opens clogged grease joints
- Forces light oil into a grease joint, flushing out old hardened grease and allowing new grease to be pushed through



Bearing Packers

GWR-2775D **\$53⁶⁵**



Hand Bearing Packer

- Use on all cage-type roller and ball bearings up to 2" bore
- Packs 50 to 60 bearings without refilling



LIS-34550 **\$42⁵⁵**



Hand Bearing Packer

- Flushes out old grease and repacks bearings
- Works on bearings up to 3-1/2" O.D.



Oil Drains & Pans

LIS-11102 **\$331³⁵**

8-Gallon Oil Lift Drain

- Height adjustment: 36-1/2" to 74"



Portable Polyethylene Oil Drains

- 18" funnel
- Gravity drain valve



Item #	Capacity	Height Adjust.	
JDI-JDI-8DCP	8-Gallon	48" - 67"	\$171.95
JDI-JDI-18DCP	18-Gallon	48" - 71"	\$316.55

Plastic Waste Oil Drains

- 16-1/2" funnel with filter screen
- Translucent tank
- Built-in easy pour handle
- Built-in parts tray



Item #	Capacity	Height Adjust.	
ATD-5180A	8-Gallon	27" - 68.9"	\$199.65
ATD-5188A	18-Gallon	37" - 76.8"	\$386.35



26-Gallon Plastic Air-Operated Used Fluid Evacuator

- Fluid types: motor oils, transmission fluids, hydraulic oil, power steering fluids, engine coolant
- Height adjustment range: 51.25" to 78.5"
- Weight: 74 lbs

FREE!

Buy #LIN-3601 and obtain #LIN-1142 for free: Heavy-Duty Manual Grease Gun with 6" Extension.



LIN-3601 **\$417²⁵**

Value Series 18-Gallon Air-Operated Used Oil Receiver

- Fluid types: motor oils, transmission fluids, power steering fluids
- 14-inch telescoping bowl
- Height adjustment range: 45" to 72"



LIN-3639 **\$967⁷⁵**

25-Gallon Combination Used Fluid Drain and Evacuator

- 15" funnel plus a 24" funnel extension
- Venturi vacuum
- Mercedes, BMW and VW dipstick tube adapters and six evacuation wands
- Height adjustment range: 51" to 76"



ATD-5200 **\$470⁵⁵**

18-Gallon Self-Evacuating Oil Drain

- Height adjustment: 46" to 76"
- Heavy duty 15" funnel
- Fluid level gauge
- 17 psi max pressure



Oil Drains & Pans



JDI-JDI-22DCX **\$1010⁷⁵**

22-Gallon Polyethylene Oil Change Station

- Height adjustment: 45" to 70"
- 16" funnel
- 3" casters, 10" rear wheels
- Built-in filter drain



JDI-JDI-LP4 **\$915⁴⁵**

17-Gallon Steel Low-Profile Oil Drain

- 10" ground clearance
- Size: 48"x 25" x 10"
- 6" casters



JDI-JDI-EK **\$295¹⁵**

Air Evacuation Kit for #JDI-LP4

Kit includes:

- 7 PSI fixed air regulator
- Safety relief valve
- 10 ft. evacuation hose
- 3/4" male & female couplers
- 2" drain plug



JDI-JDI-18DC **\$497⁵⁵**

18-Gallon Self-Evacuating Steel Oil Drain

- Automatic drain evacuation
- Height adjustment: 36.5" to 59"
- 16" funnel
- 6 ft. discharge hose



JDI-JDI-LP5 **\$1296¹⁵**

25-Gallon Steel Low-Profile Oil Drain with 110V Evacuation Pump

- 10" ground clearance
- Size: 48"x 25" x 10"
- 6" Casters



JDI-JDI-25HDC **\$1071⁷⁵**

25-Gallon Self-Evacuating Heavy-Duty Steel Oil Drain

- Automatic drain evacuation
- Height adjustment: 50" to 70"
- 16" funnel, 360° swivel
- 6 ft. discharge hose



JDI-JDI-17PLP **\$654²⁵**

17-Gallon Polyethylene Low-Profile Oil Drain

- 7-3/4" ground clearance
- Size: 49"x 29-1/2" x 7-3/4"
- 4" Casters
- Drain valve



JDI-JDI-20EV-B **\$1356⁵⁵**

20-Gallon Oil & Fluid Evacuator with Transparent Bowl

- Applications: oil, coolant, transmission fluid, brake fluid, differential oil, and power steering fluid
- 2-gallon heat-resistant, transparent bowl to check quantity and quality of oil prior to discharging into the tank
- 7 ft. suction hose
- Six suction probes for most applications
- Three "OE Style" evacuator adapters
- 10 ft. quick disconnect evacuation hose
- Sight tube for quick indication of fluid level



JDI-JDI-17PK **\$402⁹⁵**

Pump Kit for #JDI-17PLP

- 110V pump transfers fluid at 5 GPM
- Includes mounting hardware and 8 ft. evacuation hose



JDI-JDI-17FPLP **\$852⁶⁵**

17-Gallon Polyethylene Low-Profile Oil Drain with Foot Pump

- 7-3/4" ground clearance
- Size: 49"x 29-1/2" x 7-3/4"
- 4" Casters



JDI-JDI-FP1 **\$255⁷⁵**

Evacuation Foot Pump

- For transferring used oil and other nonflammable fluids from low-profile oil drains into a waste oil containment system
- 6 ft. suction hose, 8 ft. discharge hose
- Ideal for use with JDI-17PLP



JDI-JDI-6EV **\$559²⁵**

6-Gallon Steel Oil & Fluid Evacuator

- Powerful venturi vacuum system
- Self-evacuating with 10 ft. hose
- 7 ft. suction hose
- Six suction probes for most applications
- Three "OE style" evacuator adapters



Oil Drains & Pans



LIN-3665 **\$492⁴⁵**
17-Gallon (65L) Polypropylene Truck Drain

- Captures used fluids including motor oil, coolant and transmission fluid
- 6 ft. hose



LIN-3669 **\$818⁶⁵**
17-Gallon (65L) Truck Drain with Electric Pump

- Captures used fluids including motor oil, coolant and transmission fluid
- 120V electric pump
- 6 ft. hose with J-hook



FREE!

Buy #LIN-3669 and obtain #LIN-1340 for free: Lever Action Barrel Pump.

ATD-5197K **\$962⁵⁵**
17-Gallon Low Profile Oil Drain with Electric Pump

- Oversize fluid collection area with removable metal screen
- 110V electric pump
- 6.5 ft. hose with J-hook
- Size: 43.3" x 27.5" x 7.5"



LIS-19202 **\$612⁰⁵**
15 Gallon (57L) Low Profile Truck Oil Drain with Lid
 • 7-1/2" H x 32-1/4" W x 49" L

LIS-19722 **\$62⁷⁵**
Catch-All Drip Pan

- Ideal for showroom floors, garages, carports, or under equipment
- Durable polyethylene material
- Holds 8 quarts
- 24" x 36" x 1.5"



Transmission Drain Funnels

Item #	Size	
LIS-17892	22" x 23"	\$36.85
LIS-17902	24" x 36"	\$115.45



JDI-JD-2436 **\$84⁴⁵**
"Big Mouth" Transmission Drain Pan

- 38" L x 24" W x 7" H
- Stepped design adapts to any funnel with a 6" or larger diameter



ATD-5192 **\$43⁰⁵**
Transmission Drain Funnel

- Heavy-duty, flexible construction
- 22" x 23"



ATD-5183 **\$84¹⁵**
30-Quart Heavy-Duty Drain Tub

- 33" L x 22" W x 8" D



4.5-Gallon Drain Pans

- Anti-splash lip contains fluid
- Large spout for easy pouring
- 6" deep x 15.25" diameter



5184



5185

Item #	Colour	
ATD-5184	●	\$35.45
ATD-5185	●	\$37.55

4.5-Gallon Pans

- Black for oil and green for anti-freeze
- 15.7" X 17.7"



17972

17982

Item #	Colour	
LIS-17972	●	\$44.05
LIS-17982	●	\$44.05

LIS-38800 **\$35⁵⁵**
No Splatter Pad with Steel Supports

- Helps protect the work area from messy oil splatter
- Works with #17972 or #17982 4.5 Gallon Oval Drain Pans
- Resists engine oil, transmission fluid, coolant, brake fluid, brake cleaner, gear oil and other solvents
- **Not for coolants or fluids that will be recycled in the vehicle**



Oil Funnels

LIS-50240 **\$43¹⁵**

Magnetic Funnel Holder

- Translucent funnel holder accommodates various style and size funnels and stores the funnel without a mess



CTA-7333 **\$331⁶⁵**

20-Pc Oil Funnel & Adapter Kit

- 2L funnel
- Color-coded adapters fit many European, Asian & US vehicles
- Special angled extensions with locking design allows access in hard-to-reach applications



LIS-19912 **\$111¹⁵**

Multi-Application Oil Funnel Set

- The 1.6 qt. (1.5L) translucent funnel comes with 14 different colour-coded adapters and a 45° elbow
- For Domestic, Asian and VW/Audi



9CIRCLE

9CL-62731 **\$50¹⁵**

Oil Funnel for BMW & Mercedes-Benz

- **Black adapter with two tabs:**
Fits most models of BMW and Mercedes-Benz
- **Blue adapter with 1/4 turn fits:**
- BMW B37, B47, B58 engines from 2017 with cap (OEM #11 12 8 654 637);
- Mercedes-Benz M256 Hybrid, OM654 and OM656 engines from 2017 with cap (OEM #A0000180200)



9CL-62730 **\$53⁶⁵**

Volkswagen Oil Funnel

- 2015 and newer



9CL-62711 **\$44⁵⁵**

Oil Funnel for Toyota, Lexus & VAG

- Applications: Audi, BMW, Lexus, Mercedes-Benz, Porsche, Toyota, VW and Volvo



9CL-62709 **\$66⁶⁵**

Oil/Transmission Funnel Set

- Long bar is designed for transmission dipstick located in difficult to reach places, ex.: **Acura and Honda**



9CL-62705 **\$23⁴⁵**

Oil Funnel for GM

- Applications: Buick, Cadillac, Chevrolet, Chrysler, Dodge, GM, Hummer, Pontiac

LIS-19802 **\$13¹⁵**

2-Pc Threaded Oil/Transmission Super Funnel

Lisle



10" Tall Translucent Right Angle Funnels

Item #	Description	
LIS-17232	Offset Funnel	\$14.65
LIS-18232	Offset Funnel with Spout Cap and Lid	\$23.55

Flexible Funnel for Heavy Duty

9CIRCLE

- For draining and refilling different types of fluids, such as brake fluid, engine oil, transmission fluid, coolant, etc.



Item #	Size	
9CL-65066	6.7" x 14.5"	\$44.35
9CL-65067	8" x 22"	\$66.75

Oil Dispensers

Lisle

Oil Dispensers

- Marked in both quarts and liters

Item #	Capacity	
LIS-19732	6 Quart	\$34.15
LIS-19702	8 Quart	\$41.85



LIS-19602 **\$60⁵⁵**

8 Quart Low Profile Oil Dispenser

- Includes a shut-off valve and lid to keep out dirt, dust and other contaminants
- Marked in quarts and liters

Translucent Oil Dispensers

- Flexible detachable spout with cap
- Marked in both quarts and liters

Item #	Capacity	
ATD-5336	6 Quart	\$32.05
ATD-5338	8 Quart	\$42.95



Oil Filter Pliers, Sockets & Wrenches



CAL-99710 **\$38⁴⁵**
24mm & 36mm, 3/8" Dr. 6 Pt.
Oil Filter Wrench Flip Socket

- Works with a variety of domestic and foreign vehicles



GW GEARWRENCH

GWR-41890 **\$64¹⁵**
6-Pc Oil Canister Socket Set

- Low profile sockets for better access
- Sizes: 24, 27, 29, 32, 36, 38mm

LIS-13270 **\$104¹⁵**
7-Pc 3/8" Drive Very Low Profile
6 Point Filter Socket Set

- 24mm, 25mm, 27mm, 28mm, 29mm, 32mm and 36mm
- For use on oil and fuel filter canisters



Oil/
Fuel

LIS-13300 **\$74⁸⁵**
5-Pc 3/8" Drive Very Low Profile
6 Point Filter Socket Set

- 24mm, 27mm, 29mm, 32mm & 35/36mm
- For use on oil and fuel filter canisters



Oil/
Fuel

LIS-14500 **\$17⁷⁵**
35/36mm Oil/Fuel Filter
Socket for 6.0L Ford Diesel



Oil/
Fuel

LIS-14700 **\$15⁸⁵**
32mm Oil Filter Socket for
GM 2.2L Ecotec Engines



14700

LIS-40600 **\$85⁰⁵**
7-Pc Offset Filter Wrench Set

- Low profile, 6 point wrench with offset 3/8" square drive for clearance in hard-to-reach spaces
- Use on oil and fuel filter canisters



LIS-61450 **\$149³⁵**
10-Pc Heavy Duty End Cap
Filter Wrench Set

- Fit the most popular domestic and import vehicles



LIS-61460 **\$248⁸⁵**
21-Pc Heavy Duty End Cap
Filter Wrench Set

- Fit the most popular domestic and import vehicles
- Includes four new sizes to fit some Jaguar, Jeep, Land Rover, MB and Oldsmobile



ASM-2123 **\$197⁰⁵**
8-Pc Oil Filter Wrench
Socket Set

- 24mm, 27mm, 32mm, 36mm
- 64mm - 14 Flats
- 65mm - 14 Flats
- 74mm - 14 Flats
- 86.5mm - 16 Flats

Applications:

- The oil filter wrench sockets cover many foreign and domestic applications
- The 24mm covers the 3.6L found in Chrysler/Dodge/Jeep/RAM vehicles
- The 27mm, 32mm, and 36mm hex sizes covers VW/Audi, BMW, newer Mercedes 4-cyl. engines, Saturn & GM 2.2L Ecotec engines
- The 64mm covers Jaguar/Land Rover 2.0L
- The 3 cups style wrenches cover many Audi, BMW, Dodge, Ford, Mazda, Mercedes, Toyota, VW and Volvo (1999-2020) models



ASM-TOY640 **\$32⁶⁵**
64mm Toyota Oil Filter Wrench

- 14 flutes
- Fits new 3.5L and 5.7L Toyota V8 engines
- Also used to remove and install the transmission cooling return line filter on 45RFE & 545RFE transmissions found in Chrysler, Dodge and Jeep vehicles



LIS-61160 **\$67²⁵**
65mm End Cap
Wrench for
Toyota

- 14 flutes
- For 4 cylinder Toyota, Lexus and Scion



ASM-M0219 **\$33⁸⁵**
74mm Oil Filter
Wrench

- 14 flutes



ASM-2175 **\$34⁹⁵**
74.5mm Oil Filter
Socket
Wrench

- 14 flutes



ASM-M0284 **\$35⁸⁵**

84mm Oil Filter
Wrench

- 14 flutes



ASM-V410 **\$34⁸⁵**
86.5mm BMW/Volvo Oil Filter Wrench

- 16 flutes
- Fits all 1999-2006 Volvo models (except 2005 40 and 50 Series)
- Fits 2006-2017 BMW models with N20, N26, N52, N54, N55 & N63 engines



Oil Filter Pliers, Sockets & Wrenches



Oil Filter Wrenches

Item #	Size	Flutes	Applications	
9CL-61640	64.5mm	14	Toyota 4 Cylinder	\$29.75
9CL-61601	64.5mm	14	Toyota 6 & 8 Cylinder	\$29.75
9CL-61603	64.5mm	14	2-Pc Toyota/Lexus Set (#61640 & #61601)	\$58.85
9CL-61641	64.5mm	14	Toyota/Lexus & Honda/Acura • Provides high torque: 264 ft-lb	\$42.45
9CL-61660	74.2mm	14	Ford, Audi, BMW, Mazda, Toyota, Porsche, MB, VW	\$29.95
9CL-61604	84.4mm	14	Diesel Cartridge Oil Filter Wrench Dodge/Mercedes-Benz Sprinter (2007/-), Mercedes-Benz V6 & V8 Diesel, Jeep Cherokee 3.0L V6 Diesel (2007/-)	\$31.15
9CL-61650	86.6mm	16	BMW & Volvo Oil Filter Wrench BMW: 335i 3.0L Twin Turbo, 535i 3.0L Twin Turbo, 3 Series 2006-2011, X6 3.0L Twin Turbo Volvo: All models 1999-2006, excl. 40 & 50 series	\$30.55
9CL-61651	86.6mm	16	BMW (Gasoline & Diesel) Oil Filter Wrench BMW: 335i 3.0L Twin Turbo, 535i 3.0L Twin Turbo, 3 Series 2006-2011, X6 3.0L Twin Turbo	\$32.05
9CL-61630	88.8mm	15	Hyundai & Kia Oil Filter Wrench Hyundai and Kia SUV with Diesel engines	\$28.55
9CL-61605	90.2mm	15	Land Rover Oil Filter Wrench Land Rover LR4, Land Rover Range Rover, Land Rover Range Rover Sport	\$31.15
9CL-61662	93mm	36	Ford • Made of forged steel	\$53.45



Oil Filter Wrenches

Item #	Size	Flutes	Drive	Applications	
CTA-2465	64mm	14	3/8"	Toyota/Lexus/Scion 6 & 8 cylinder	\$38.25
CTA-2475	64mm	14	1/2"	Extra heavy-duty wrench for Toyota/Lexus	\$54.85
CTA-1726	64mm	14	1/2"	Toyota/Lexus/Scion 4, 6 & 8 cylinder (excluding Prius)	\$50.95
CTA-A250	74mm/76mm	15	3/8"	Various AC Delco, FRAM, MOPAR, Motorcraft, NAPA, OEM Mazda, Penzoil, Purolator, WIX	\$6.35



LAN-524 **\$53.95** 24 & 36mm Fuel/Oil Filter Socket

- 3/8" drive double sided socket
- Lifetime warranty



Oil/
Fuel

9CIRCLE®

9CL-62607 **\$298.65**

13-Pc Oil Filter Wrench Set

- Covers most cartridge oil filters including: Audi, BMW, Dodge, Ford, GM, Hyundai, Jeep, Kia, Land Rover, Lexus, Mazda, Mercedes, Toyota, Volkswagen, and Volvo
- Includes a universal oil filter wrench for oil canisters (2-1/2" to 3-1/4" / 63-83 mm)



CTA-026400 **\$99.45**

10-Pc Cartridge-Type Oil Filter Wrench Kit

Includes 6 cap wrenches:

- #2485 - 64mm x 14 Flute
- #A258 - 74mm x 15 Flute
- #A267 - 74.5mm x 14 Flute
- #A251 - 76mm x 14 Flute
- #A261 - 86mm x 16 Flute
- #A266 - 88mm x 15 Flute



- Includes 4 cap sockets:
- #2573 - 27mm
 - #2570 - 24mm
 - #2572 - 32mm
 - #2574 - 36mm



CTA-096950 **\$99.45**

11-Pc Cap-Type Oil Filter Wrench Kit for Spin-On Filters

- #A255 - 65/67mm x 14 Flute
- #A256 - 68mm x 14 Flute
- #A254 - 73mm x 14 Flute
- #A258 - 74mm x 15 Flute
- #A250 - 74/76mm x 15 Flute
- #A263 - 76mm x 8 Flute
- #A251 - 76mm x 14 Flute
- #A264 - 76mm x 15 Flute
- #A257 - 80mm x 15 Flute
- #A252 - 93mm x 15 Flute
- #A253 - 93mm x 36 Flute



ATD-5231 **\$242.05**

31-Pc Cartridge-Type Oil Filter Wrench Set

- Fits many BMW, Volvo, Honda, Audi, Ford, Toyota and Nissan models with cartridge oil filters
- Includes (28) 3/8" drive oil cartridge filter sockets in a wide range of sizes, a socket drive wrench and (2) adjustable filter wrenches



Toyota/Lexus Oil Filter Wrenches

Item #	Size	Flutes	Applications	
PBT-71110A	64.5mm	14	Toyota/Lexus 4 cylinder	\$39.15
PBT-71113A	64.5mm	14	Toyota/Lexus 6 & 8 cylinder	\$39.15
PBT-71115A	Kit Includes: #71110A, #71113A + #71114 Drain Hose Assembly		Toyota/Lexus 4, 6 & 8 cylinder	\$126.85

71113A



71114

Oil Filter Pliers, Sockets & Wrenches

ATD-5208 **\$15⁸⁵**
1/2" Drive Strap Filter Wrench
 • Use with 1/2" square drive wrench
 • Fits filters up to 6"



ATD-5375 **\$48⁷⁵**
Deluxe Strap Filter Wrench
 • 3/8" and 1/2" engagement
 • Fits filters up to 9"



LIS-60200 **\$47⁵⁵**
1/2" Drive Heavy Duty Strap Filter Wrench
 • To remove or install filters and other objects up to 6-1/2" in diameter



GWR-3149 **\$13¹⁵**
Nylon Strap Oil Filter Wrench
 • For oil filters up to a 6" (152mm)



CAL-803 **\$46⁰⁵**
Heavy-Duty Strap Oil Filter Wrench
 • 3/8" and 1/2" drive engagement
 • Fits filters up to 9" (228mm)



Filter Wrenches

Item #	Diameter	
LIS-63600	2-1/2" to 3-1/8"	\$22.85
LIS-63250	3-1/8" to 3-7/8"	\$23.45



LIS-63890 **\$54⁵⁵**
3-Jaw Heavy-Duty Oil Filter Wrench with Adapter
 • Use with 3/8" or 1/2" square drive or 21mm wrench or socket
 • Fits filters from 73mm-153mm



GWR-3288D **\$23²⁵**
Universal 3-Jaw Oil Filter Wrench
 • Remove all passenger car and light-duty truck spin-on type filters
 • Sizes range from 2-1/2" to 3-3/4"



CTA-4324 **\$41¹⁵**
4-Pc Oil Filter Wrench Kit with Magnetic Stand
 • (2) Band-type oil filter wrenches: 64-83mm, 83-95mm
 • (1) Strap-type oil filter wrench: 152mm (6") diameter
 • (1) Swivel oil filter wrench: adjustable from 76-102mm (3" - 4-1/32")



4326

Swivel-Type Oil Filter Wrench Sets with Magnetic Stand



Item #	Content	Set Range	
CTA-4325	4-Piece	57mm to 111mm	\$102.05
CTA-4326	6-Piece	57mm to 146mm	\$140.35



Swivel Grip Oil Filter Wrenches



Item #	Description	Diameter	
LIS-54400	Oil/Fuel Filter Wrench	2-3/8" to 2-5/8"	\$19.65
LIS-53700	Small Oil Filter Wrench	2-7/8" to 3-1/4"	\$18.75
LIS-53500	Standard Oil Filter Wrench	3-1/2" to 3-7/8"	\$19.05
LIS-53250	Large Oil Filter Wrench	4-1/8" to 4-1/2"	\$20.95
LIS-54200	Cummins & Detroit Diesel Engines	4-5/16" to 4-3/4"	\$26.65
LIS-54300	Caterpillar Engines	5-1/4" to 5-3/4"	\$27.85

Swivel-Griper™ "No-Slip" Oil Filter Wrenches



Item #	Description	Diameter	
LIS-57010	Extra Small Swivel-Griper	2-3/8" to 2-5/8"	\$25.95
LIS-57020	Small Swivel-Griper	2-7/8" to 3-1/4"	\$24.45
LIS-57030	Standard Swivel-Griper	3-1/2" to 3-7/8"	\$25.15
LIS-57040	Large Swivel-Griper	4-1/8" to 4-1/2"	\$26.65
LIS-57050	Cummins & Detroit Diesel Engines	4-5/16" to 4-3/4"	\$34.65
LIS-57060	John Deere Engines	4-3/4" to 5-3/16"	\$35.25
LIS-57070	Caterpillar Engines	5-1/4" to 5-3/4"	\$35.85

Pro Swivoil™ Oil Filter Wrenches



Item #	Diameter	
GWR-3941	2.52" to 2.99" (64 to 76mm)	\$27.85
GWR-3942	2.87" to 3.27" (73 to 83mm)	\$27.85
GWR-3943	3.50" to 3.90" (89 to 99mm)	\$29.55
GWR-3944	3.78" to 4.37" (96 to 111mm)	\$31.75



Swivoil™ Oil Filter Wrenches

Item #	Diameter	
GWR-3083D	2-7/8" to 3-1/4"	\$14.15
GWR-3082D	3-1/2" to 3-7/8"	\$13.85



Oil Filter Pliers, Sockets & Wrenches

GEARWRENCH

Heavy-Duty Truck Oil Filter Wrenches



Item #	Band	Diameter	
GWR-2320D	1-1/2"	3-3/4" to 4-1/2"	\$37.15
GWR-2321	1-1/2"	4-1/2" to 5-1/4"	\$38.25
GWR-2322D	1-1/2"	5-1/4" to 5-3/4"	\$37.15
GWR-2320W	3"	4-1/8" to 4-1/2"	\$45.65
GWR-2321W	3"	4-3/8" to 5-1/4"	\$45.65
GWR-2322W	3"	4-3/4" to 5-1/2"	\$45.65



Heavy-Duty Truck Oil Filter Wrenches

- Two sets of dimples have been added to create a non-slip surface on the band

Item #	Band	Diameter	
LIS-53030	3"	3-3/4" to 4-1/2"	\$63.45
LIS-53050	3"	4-1/4" to 5-1/4"	\$64.75
LIS-53090	3"	5-1/4" to 5-3/4"	\$65.95



Pliers for Oil Filters and PVC Conduits & Fittings

Item #	Length	Capacity	Adjustments	
CNL-209	9"	1.75" to 3"	4	\$34.45
CNL-212	12"	2.5" to 3.75"	5	\$47.55
CNL-215	15.5"	2.5" to 4.5"	6	\$57.15

Oil Filter Pliers

Item #	Capacity	
LIS-50750	2-1/4" to 4"	\$52.65
LIS-50950	3-5/8" to 6"	\$72.15



9" Comfort Grip Pliers for Oil Filters, PVC Conduits & Fittings

- 3.5" jaw capacity



Auto Adjusting Locking Oil Filter Pliers

- Range: 2.36" to 4.72"



Adjustable Oil Filter Pliers

Item #	Capacity	
CAL-302	2-1/4" to 6"	\$44.75
CAL-291	3-3/4" to 7"	\$78.85

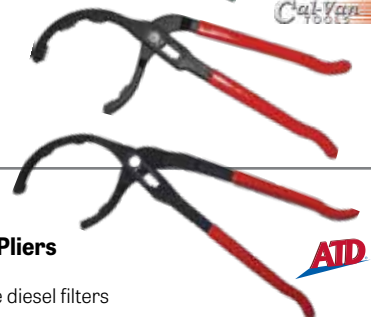

17" Truck and Tractor Filter Pliers

- Range: 3-3/4" to 7"
- Use on virtually all CAT and large diesel filters

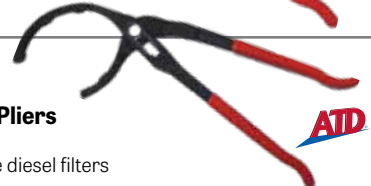

Oil Drain Plug Tools

9CIRCLE®

Oil Drain Plug Repair/Replacement Kit

- M15 x 1.50 for replacing standard size M14 x 1.50
- For Honda, Acura, VW, Audi, Mitsubishi, Mazda, Hyundai, and Ford



Volkswagen Nylon Drain Plug Replacement Set with Tools

- For Nylon drain plugs used on recent Volkswagen and Audi

Lisle

LIS-58850 \$228³⁵

Oil Pan Plug Rethreading Kit

- Works on soft steel and aluminum oil pans with 1/2", 12mm & 14mm threads



LIS-58650 \$44⁴⁵

5-Pack Plug and Gasket Set for #LIS-58850 Oil Pan Plug Rethreading Kit



ATA

CTA-1320 \$132⁶⁵

8-Pc Drain Plug Kit

- Used for removing plastic drain plugs found on many late model vehicles
- Services both oil drain plugs and radiator drain plugs
- Applications: GM, Ford, Lincoln, Dodge, Mercedes Benz, BMW, Porsche, Volkswagen & Audi



ATA

CTA-2495K \$79⁰⁵

8 in 1 Oil and Lube Magnetic Multi-Wrench, 6 Point

- Sizes: 12, 13, 14, 15, 16, 17, 18, 19mm
- Sizes fit most oil drain, transfer case and differential plugs



OTC

OTC-5911A \$31⁶⁵

Magnetic Drain Plug Pro™

- Removes pre-loosened oil pan drain plugs without dropping them
- Provides universal application to hex heads



Oil Drain Plug Tools

CTA-1037 **\$13⁹⁵**

Audi/VW/Volvo Oil Drain Plug Tool

- Removes new, plastic oil drain plugs without damage
- Also removes Volvo Haldex system plugs



ASM-VW549L **\$30⁴⁵**

Long Oil Drain Plug Tool for VW/Audi

- For use on 2015+ VW/Audi with 1.8L and 2.0L turbo gas engines
- Comparable to VW #T10549, and Hazet #2528-1



SUN-3841 **\$112⁴⁵**

11-Pc 3/8" Drive Pipe Plug Socket Set

- For use on most vehicles
- Male: 3/16" to 3/8"
- Female: 1/4" to 3/8"



SUNEX
TOOLS

SUN-2841 **\$106⁷⁵**

8-Pc 1/2" Drive Pipe Plug Socket Set

- For use on most vehicles
- Male: 7/16" to 5/8"
- Female: 7/16" to 5/8"



Lube Meters



LIN-982 **\$561⁸⁵**

Electronic Lube Meter

- Display units: pints, quarts, gallons or liters
- Fluids applicable: Motor oils (SAE 5 through 30), gear oils (SAE 80 through 240), ATF, engine coolant, windshield wiper fluid solution
- Includes: control valve, meter, 13" flexible extension, automatic tip



Mechanical Lube Meters

- For oil, ATF and antifreeze
- 10" flexible spout

Item #	Units	
LIN-877	Quarts	\$622.55
LIN-899	Liters	\$900.25



LIN-905 **\$936⁶⁵**

Digital Lube Meter

- Resettable and non-resettable totalizer
- Display units: pints, quarts, gallons or liters
- For oil, ATF and antifreeze



PIU-F0068600D **\$908²⁵**

K500 Preset Metered Oil Nozzle

- Meter with adjustable unit of measurement
- Flow rate: 1-30 L/Min (0.3-8 GPM)
- Max operating pressure: 1,000 PSI
- Viscosity: 2,000 CST • Inlet: 1/2" NPT
- Preset function (preset memory up to 5 records)
- Automatic no drip valve • Rotating spout
- Powered by four AAA batteries



PIU-F00973150 **\$341⁶⁵**

Easy K40 Oil Nozzle with Mechanical Metered Nozzle

- Meter with Liters reading
- Flow rate: 1-30 L/Min (0.3-8 GPM)
- Pressure: 1,000 PSI
- Viscosity: 2,000 CST • Inlet: 1/2" NPT
- Automatic no drip valve
- No calibration required • Easy to reset
- Partial and full totalizer • Non-resettable totalizer
- Mechanical reset button • Swivel



PIU-F00984260 **\$446³⁵**

Easy K400 Oil Nozzle with Electronic Flow Meter

- Meter with adjustable unit of measurement
- Flow rate: 1-30 L/Min (0.3-8 GPM)
- Max operating pressure: 1,000 PSI
- Viscosity: 2,000 CST • Inlet: 1/2" NPT
- 5-digit partial total • Double totalizer
- Electronic reset function • Easy to calibrate
- Automatic no drip valve • Swivel
- Powered by two AAA batteries



PIU-F00974070 **\$696²⁵**

NEXT/2 High Flow Rate Oil Nozzle with Electronic Flow Meter – Quarts/Gallons

- Meter with adjustable unit of measurement
- Flow rate: 6-60 L/Min (1.5-15 GPM)
- Maximum operating pressure: 1,000 PSI • Viscosity: 2,000 CST • Inlet: 3/4" NPT • Automatic no drip valve
- Swivel • Powered by two AAA batteries



Oil Pumps

TURBO XL



5:1 Pneumatic Oil Pumps

Item #	Capacity	Flow	Length	
TXL-PU05060	60L (16 Gal)	14L/min (3.6 GPM)	29"	\$606.45
TXL-PU05205	205L (54 Gal)	14L/min (3.6 GPM)	37"	\$609.55
TXL-PU05060HD	60L (16 Gal)	40L/min (10.5 GPM)	29"	\$1030.65
TXL-PU05205-HD	205L (54 Gal)	40L/min (10.5 GPM)	37"	\$1102.95

OTC

OTC-2352 **\$103³⁵**

Lever Action Bucket Pump

- For use with transmission, differential & heavier oils
- Up to 4.6 oz. / stroke
- Fits 5 gallon pails
- Includes 12" drum cover
- 3 position handle for different fluid viscosity
- Supplied with 5 ft. hose



ATD

ATD-5008 **\$108⁵⁵**

Lever Action Oil Transfer Pump

- For use with transmission, differential and heavier oils
- Up to 2.14 oz. / stroke
- Includes 18" pump and 12" cover for 25-50 lbs drums/5 gallon pails
- 4 ft. hose with nozzle

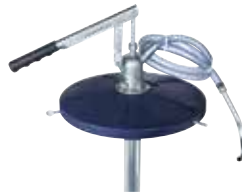

LMX

LMX-LX-1300 **\$74²⁵**

Lever Action Bucket Pump

- Ideal for transferring motor oil, transmission fluid, differential fluid, heavier oils and other automotive additives
- Delivers 1 quart (32 oz.) / 12 strokes
- Fits 25-50 lbs / 5 gallon pails
- 18" x 1-1/2" suction tube
- 12" cover, 5 ft. flex hose with nozzle



LIN-4491 **\$832⁶⁵**

Value Series Oil Transfer Pump

- For oil, ATF, gear oil and other fluid lubricants
- Pump ratio: 3.5:1
- Application: 250 to 275 gallon tank
- Output per stroke: 5.6 cubic inch (91 cubic cm)
- Delivery output: 6 gpm (22 LPM)
- Down tube length: 47"



LIN-279092

Oil Trolley Kit

- Dispenses oil directly from 55-gallon or 400-pound drums
- Includes:
 - Heavy duty trolley
 - Series 25 universal 3:1 pump
 - Heavy duty reel with 30 ft. (9 m) hose
 - Electronic meter that measures pints, quarts, gallons or liters
 - Air control with filter/regulator/gauge
 - Oil connection hoses and fittings
- **Drum not included**



TXL-PU05060KD-HD **\$1311⁸⁵**

Pneumatic Oil Pump Kit for 60L (16 Gallon) Drums

- Flow: 40L/min (10.5 GPM)
- Pump: 5:1 ratio
- Cart for 60L drum
- Digital oil control nozzle with rigid spout
- Hose: 25 ft. x 1/2"
- Drum cover



TXL-PU05205KD-HD **\$1451⁸⁵**

Pneumatic Oil Pump Kit for 205L (54 Gallon) Drums

- Flow: 40L/min (10.5 GPM)
- Pump: 5:1 ratio
- Cart for 205L drum
- Digital oil control nozzle with rigid spout
- Hose: 25 ft. x 1/2"



TXL-PU05205KDR-HD **\$1946⁵⁵**

Pneumatic Oil Pump Kit for 205L (54 Gallon) Drums

- Flow: 40L/min (10.5 GPM)
- Pump: 5:1 ratio
- Cart for 205L drum
- Digital oil control nozzle with rigid spout
- Hose reel: 50 ft. x 1/2"
- Hose: 6 ft. x 1/2"



ATD-5226 **\$2822⁵⁵**

Trolley Mounted Air-Operated Oil Pump Kit

- 3:1 ratio pump with 2" bung
- Designed for use with 55 gal. (205 L) oil drums (not included)
- Digital oil gun with flexible hose and manual non-drip tip
- Hose: 30 ft. x 1/2"
- Trolley with locking wheels



Grease Pumps



LINCOLN

LIN-279091



Grease Trolley Kit

- Dispenses grease directly from 55-gallon or 400-pound drums
- Includes: heavy duty trolley, Series 20 50:1 pump with cover, follower for 400 lb (181 kg) drums, heavy-duty reel with 30 ft (9 m), high-pressure hose, control valve, universal swivel, air control with filter/regulator/gauge and grease connection hoses and fittings
- Drum not included



LINCOLN



FREE!

Buy #LIN-6917 and obtain #LIN-5805 for free: 6" Long Grease Fitting Cleaning Tool Kit.

LIN-6917



Air-Operated Portable Grease Pump Package

- Ratio: 50:1
- Works with 120 lb drum (not included)
- Max. pressure: 7,500 psi
- Output: 80 cubic in./min
- 7 ft. heavy duty grease hose, heavy duty control valve and universal swivel, standard follower
- Four-wheel dolly

LINCOLN



Buy #LIN-917 and obtain #LIN-58000 for free: 7-Pc Heavy-Duty Grease Adapter Kit.

FREE!

LIN-917



Lubrigrun Air-Operated Portable Grease Pump Package

- Ratio: 50:1
- Works with 120 lb drum (not included)
- Max. pressure: 7,500 psi
- Output: 80 cubic in./min.
- 7 ft. grease hose, heavy-duty control valve and swivel, universal follower
- 17" roll-a-round base



LIN-989



Air-Operated Double Acting Heavy Duty Grease Pump

- Ratio: 50:1
- Works with 25-50 lb containers (not included)
- Max. pressure: 7,500 psi
- Output: 80 cubic in./min.
- 7 ft. grease hose, control valve, straight and universal swivels, drum cover, flexible follower plate

LINCOLN



ATD

ATD-5225

\$3126⁴⁵

Trolley Mounted Air-Operated Grease Pump Kit

- Pump: 50:1 ratio
- Designed for use with 55 gal. (400 lbs) grease drums (not included)
- 30 ft. x 1/4" grease hose, control valve with swivel, follower plate, drum cover
- Trolley with locking wheels



TURBO XL

TXL-PU50060K

\$883⁴⁵

Air-Operated Portable Grease Pump Package

- Ratio: 50:1
- Works with 120 lb drum (not included)
- Output: 8,000 gr/min
- 20 ft. grease hose, control valve with swivel, follower plate, drum cover
- Trolley for 55 kg drums



Hose Reels for Oil & Grease

Professional Series Hose Reels for Oil and Grease

- Heavy-duty steel construction
- Corrosion resistant powder-coat finish
- Guide arm is adjustable up to nine positions permitting wall, ceiling or floor mount

JD JohnDow Industries



JDI-1450

Item #	Applications	PSI Rating	Hose	
JDI-JDM-3850	Oil & ATF	2,250 PSI	3/8" x 50 ft.	\$571.85
JDI-JDM-1250	Oil & ATF	2,250 PSI	1/2" x 50 ft.	\$610.05
JDI-JDH-1450	Grease	5,000 PSI	1/4" x 50 ft.	\$621.35

TURBO XL

High Pressure Hose Reels for Oil and Grease

Item #	Applications	PSI Rating	Hose	
TXL-H820102	Grease	5,000 PSI	1/4" x 33 ft.	\$524.45
TXL-H808203	Oil & Grease	4,000 PSI	3/8" x 65 ft.	\$850.95

H808203



REELCRAFT

RFT-7850 OMP

\$948⁹⁵

Medium Pressure Oil Reel

- 50 ft. x 1/2"
- Hose outlet/reel inlet: 1/2" NPT
- Max. pressure: 3,000 psi
- Max. temperature: 210°F (99°C)



Made in USA

Face Shields/Visors



Standard Face Shields

- Impact-resistant polycarbonate shield for long lasting protection
- Curved design protects a larger area for facial protection
- Push and turn ratchet-sizing adjustment
- Easy dial adjustment for individual visor positioning
- Suitable for general grinding applications
- Window size: 203mm (H) x 254mm (W) • Thickness: 1.5mm
- Meets ANSI Z87.1-2015 standards

Item #	Description	Colour	
SAS-5140	Standard Face Shield	Clear	\$24.95
SAS-5142	Standard Face Shield	Dark Green*	\$24.95
SAS-5150	Standard Replacement Lens	Clear	\$11.85

* Not suitable for welding



Deluxe Face Shields

- Impact-resistant polycarbonate shield for long lasting protection
- Aspherical lens design provides larger area for facial protection
- Large spark deflection
- Push and turn ratchet-sizing adjustment
- Tension dials increase and decrease tension of shield placement
- Closer curved fit for comfort and greater range of motion
- Window size: 203mm (H) x 235mm (W) • Thickness: 1.5mm
- Meets ANSI Z87.1-2015

Item #	Description	Colour	
SAS-5145	Deluxe Face Shield	Clear	\$35.65
SAS-5147	Deluxe Face Shield	Dark Green*	\$35.35
SAS-5155	Deluxe Replacement Lens	Clear	\$13.15
SAS-5157	Deluxe Replacement Lens	Dark Green*	\$13.15

* Not suitable for welding

Masks & Respirators

TBQ-NB-0128 **\$2⁶⁵**
3-Ply Disposable Face Mask

- High filtration capacity
- Easy to breathe fabric
- Adjustable nose bar
- Box of 50 masks



Dual Cartridge Respirator Packout, Organic Vapor/P95

- Includes 2 pairs of P-95 filters (#07194)
- For spray paint applications
- For occupational use only

Item #	Size	
3MM-7178	Medium	\$81.35
3MM-7179	Large	\$81.35



SAS-8661-92 **\$26²⁵**



Bandit® Disposable Dual Cartridge Respirator with Organic Vapor/N95 Filters

- Size: Medium
- Pre-assembled respirator
- Face piece is lightweight, flexible and comfortable with a secured fit
- Adjustable head strap
- Low profile cartridge
- Resealable storage bag



SAS-8611 **\$27²⁵**

N95 Valved Particulate Respirator

- Lightweight, maintenance-free construction
- Exhalation valve reduces hot air build up
- Adjustable nose bridge with foam strip
- Latex-free stapled head strap
- Box of 10 masks



Neck Gaiters



Multi-Functional Neck Gaiters

- Moisture wicking fabric
- Washer and dryer safe
- Anti-microbial treatment prevents odors & bacteria build-up
- Blocks 98% of UV rays
- 86% Polyester, 14% Spandex



Item #	Colour	
MLW-423G	Gray	\$19.75
MLW-423HV	High Vis	\$19.75
MLW-423R	Red	\$19.75



Knee Pads

DEW-DWST590012 **\$53⁵⁵**

Stabilizing Knee Pads with Gel

- Semi-rigid, TPE flat cap designed for slip prevention on unbalanced surfaces
- Protective gel zone, multiple layers of support, and swiveling buckles for comfort on long days
- Dual straps with quick adjustment



DEW-DWST590013 **\$54⁵⁵**



Hard-Shell Knee Pads with Gel

- Protective cap withstands repeated traction
- Protective gel zone, multiple layers of support, and swiveling buckles for comfort on long days
- Dual straps with quick adjustment



DEW-DWST590014 **\$34⁴⁵**

Flooring Knee Pads with Gel

- Soft, durable outer surface protects finished surfaces from scuff marks
- High-density foam, a protective gel zone, and swiveling buckles for comfort on long days
- Dual straps with quick adjustment



MLW-48-73-6040 **\$53⁹⁵**

Non-Marring Performance Knee Pads

- Robust, durable cap for longest life
- Pressure reducing foam maintains shape
- Layered gel absorbs pressure and supports knee
- 2 secure adjustable buckles
- Soft, comfortable straps



SAS-7102 **\$24⁵⁵**

Deluxe Knee Pads

- Plastic cap over tough nylon fabric with soft foam rubber core
- Water and abrasion resistant
- Hook-and-loop closures



SAS-7105 **\$35⁴⁵**

Deluxe Gel Knee Pads

- Super-thick 1/2" high density closed-cell foam
- Large, low-profile cap designed to prevent "roll over"
- Anti-compression air injected gel
- Hook-and-loop closures



MUK-905 000-3 **\$106⁶⁵**

3-Pc Kneeling Pads Set

- Resistant to UV, oil, gas, water and numerous other chemicals
- Can be used for seat protection
- Dimensions: 19" x 12-1/2" x 1-1/2"

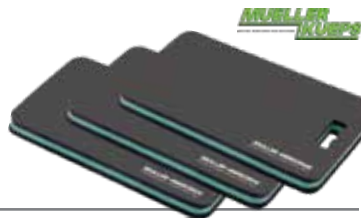

GWR-86996 **\$40³⁵**



225 Lbs Capacity Extra Large Kneeling Pad

- Solvent resistant EVA foam
- Magnetic parts tray for convenient storage
- 24" x 16" x 1-1/8"



Safety Glasses



12261



12262

Privo™ Protective Eyewear

- Soft tips and temples, gentle nosebridge
- Sturdy polycarbonate lens with anti-fog coating



12263

Item #	Description	
3MM-12261	Clear Lens	\$12.35
3MM-12262	Gray Lens	\$13.85
3MM-12263	Amber Lens	\$13.45
3MM-12264	Mirror Lens	\$15.85



12264

48-73-2020



48-73-2025

48-73-2120



48-73-2125



Performance Safety Glasses

- High impact protection, with fog-free and anti-scratch lenses

Item #	Lenses	
MLW-48-73-2020	Clear	\$23.35
MLW-48-73-2025	Tinted	\$23.35
MLW-48-73-2120	Yellow	\$23.35
MLW-48-73-2125	Grey	\$23.35



Performance Safety Glasses with Removable Gasket

- Removable gasket protects your eyes against debris

Item #	Lenses	
MLW-48-73-2040	Clear	\$34.15
MLW-48-73-2045	Tinted	\$44.85

Eye Protection

SAS-5134-00 **\$355⁴⁵**

9-Gallon Portable Emergency Eyewash Station

- One-hand operation
- Gravity fed, no plumbing required
- Provides a min. 15-minute flushing period
- Lockable cap
- Measures: 9.5" x 16.5" x 20.15"
- Compliance - ANSI Z358.1-2014
- Includes: mounting bracket (#5134-12), inspection tag (#5137) and preservative for eyewash (#5136-01)
- Change water every 3 to 6 months



Hearing Protection

ISOtunes

ISO-IT-48 **\$180⁸⁵**

ISOtunes LINK 2.0 Bluetooth® 5.0 Earmuffs

- Noise-isolating hearing protection
- Noise reduction rating: 25 dB
- Exceptional audio quality
- Padded headband cushion
- Up to 50 hours of battery life
- Includes: USB cable & battery



Shown with optional microphone

ISO-IT-85 **\$38¹⁵**

ISOtunes Boom Microphone

- Only compatible with LINK 2.0 (#IT-48)
- Noise-reducing microphone attachment for clearer calls in loud environments
- Adjustable boom allows for a custom fit and comes with a replacement windscreen



ISOtunes FREE True Wireless Bluetooth® Earplugs

- 7+ hours battery life
- OSHA-compliant hearing protection
- High fidelity aptX audio
- Noise reduction rating: 22 dB
- Noise-isolating microphone for clear calls in loud environments
- Siri/Google voice compatible
- Includes: 3 pairs of foam ear tips, 3 pairs of silicone double flange ear tips, USB-C cable, portable charging case



Item #	Colour	Price
ISO-IT-13	Black	\$177.05
ISO-IT-14	Green	\$177.05

ISOtunes PRO 2.0 Bluetooth® Earplugs

- OSHA-compliant hearing protection
- Noise reduction rating: 27 dB
- Noise-isolating microphone
- 16+ hours battery life

Item #	Colour	Price
ISO-IT-21	Orange	\$160.95
ISO-IT-23	Black	\$160.95



ISO-IT-22 **\$126⁵⁵**

ISOtunes Xtra 2.0 Earplugs with Bluetooth® 5.0

- MAGNETIC EAR TIPS:
 - Play/Pause music
 - Answer/End calls,
 - Keep earbuds safely around your neck
- OSHA-compliant hearing protection
- Noise reduction rating: 27 dB
- Noise-isolating microphone
- 11+ hours battery life



MAGNETIC

SAS-6105 **\$17⁴⁵**

Standard Earmuffs

- Lightweight hearing protector
- Noise reduction rating: 23



SAS-6102 **\$8⁴⁵**

Reusable Banded Ear Caps

- Noise reduction rating: 23 dB

SAS-6100 **\$51⁸⁵**

Soft Foam Ear Plugs

- Noise reduction rating: 31
- Box of 200 pairs



MLW-2191-21 **\$248⁹⁵**

REDLITHIUM™ USB Bluetooth® 5.1 Jobsite Ear Buds

- Up to 70 hours of runtime using multiple in-case charges
- Bluetooth® 5.1 range: up to 55 ft.
- Phone call capable
- Noise reduction rating:
 - Foam ear tips: 25 dB
 - Silicone: 22 dB

Includes:

- Charging case, USB-C cable, REDLITHIUM™ USB 3.0 battery
- (3) Pairs each of silicone ear tips, foam ear tips, ear wings & cover bands



MLW-48-73-3201 **\$9⁶⁵**

Banded Ear Plugs

- Includes interchangeable foam and flanged ear plugs
- Noise reduction rating up to 25 dB



MLW-48-73-3206 **\$8⁶⁵**

Replacement Tapered Shape Foam Ear Plugs

- Noise reduction rating of 25 dB
- Compatible with Milwaukee banded ear plugs (#48-73-3201)
- Pack of 10 ear plugs

MLW-48-73-3205 **\$8⁶⁵**

Replacement Flanged Soft Silicone Ear Plugs

- Noise reductions rating: 26dB
- Compatible with Milwaukee banded ear plugs (#48-73-3201)
- Pack of 10 ear plugs

MLW-48-73-3151 **\$3⁸⁵**

Reusable Corded Ear Plugs, 3-Pack

- Noise reduction rating: 26 dB



Disposable Gloves

93-260 Chemical Resistant Nitrile + Neoprene Disposable Gloves

- Extra soft and thin material
- Textured fingertips, beaded cuff
- Finger thickness: 9 mil • Length: 11.8"
- 50 Teal Green gloves/box

Item #	Size	Price
MCF-93260070	Small	\$23.05
MCF-93260080	Medium	\$23.05
MCF-93260090	Large	\$23.05
MCF-93260100	X-Large	\$23.05
MCF-93260110	XX-Large	\$23.05



SAFEGRIP® Extended Cuff Powder-Free Disposable Latex Gloves

- 3x thicker than standard latex gloves
- Textured fingertips, beaded cuff
- Finger thickness: 14 mil • Length: 11.6"
- 50 Blue gloves/box

Item #	Size	Price
MCF-SG-375-S	Small	\$16.85
MCF-SG-375-M	Medium	\$16.85
MCF-SG-375-L	Large	\$16.85
MCF-SG-375-XL	X-Large	\$16.85



DURA FLOCK® Flocked-Lined Nitrile Industrial Grade Disposable Gloves

- Fully textured grip, beaded cuff
- Finger thickness: 8 mil
- Length: 10.6" • 50 Green gloves/box

Item #	Size	Price
MCF-DFK-608-M	Medium	\$34.95
MCF-DFK-608-L	Large	\$34.95
MCF-DFK-608-XL	X-Large	\$34.95
MCF-DFK-608-XXL	XX-Large	\$34.95



SUPRENO® SE Powder-Free Nitrile Disposable Gloves

- Textured fingers, beaded cuff
- Finger thickness: 7 mil • Length: 9.6"
- 100 Blue Violet gloves/box

Item #	Size	Price
MCF-SU-690-XS	X-Small	\$17.95
MCF-SU-690-S	Small	\$17.95
MCF-SU-690-M	Medium	\$17.95
MCF-SU-690-L	Large	\$17.95
MCF-SU-690-XL	X-Large	\$17.95



DIAMOND GRIP™ Powder-Free Disposable Latex Gloves

- Textured fingers, beaded cuff
- Finger thickness: 8 mil
- Length: 9.6" • 100 Natural Colour gloves/box

Item #	Size	Price
MCF-MF-300-M	Medium	\$17.75
MCF-MF-300-L	Large	\$17.75
MCF-MF-300-XL	X-Large	\$17.75



Raven® Powder-Free Nitrile Disposable Gloves

- Textured for excellent chemical resistance and great grip
- Thickness: 6 mil • 100 Black gloves/box

Item #	Size	Price
SAS-66517	Medium	\$23.45
SAS-66518	Large	\$23.45
SAS-66519	X-Large	\$23.45
SAS-66520	XX-Large	\$23.45



MIDKNIGHT™ Premium Powder-Free Nitrile Disposable Gloves

- Fully textured grip, beaded cuff
- Finger thickness: 6 mil • Length: 9.6"
- 100 Black gloves/box

Item #	Size	Price
MCF-MK-296-XS	X-Small	\$15.05
MCF-MK-296-S	Small	\$15.05
MCF-MK-296-M	Medium	\$15.05
MCF-MK-296-L	Large	\$15.05
MCF-MK-296-XL	X-Large	\$15.05
MCF-MK-296-XXL	XX-Large	\$15.05



Thickster® Ultra Thick Powdered Latex Disposable Gloves

- Fully textured for superior grip
- Beaded cuff • Thickness: 14 mil
- Length: 12" • 50 Blue gloves/box

Item #	Size	Price
SAS-6602	Medium	\$23.55
SAS-6603	Large	\$23.55
SAS-6604	X-Large	\$23.55
SAS-6605	XX-Large	\$23.55



ONYX® General Purpose Powder-Free Nitrile Disposable Gloves

- Textured fingertips, beaded cuff
- Finger thickness: 5 mil
- Length: 9.6"
- 100 Black gloves/box

Item #	Size	Price
MCF-N642	Medium	\$13.65
MCF-N643	Large	\$13.65
MCF-N644	X-Large	\$13.65



LIS-20130 **\$41⁸⁵**

Magnetic or Wall-Mount Glove Dispenser

- Made of powder coated steel
- Fits all common sizes of disposable glove boxes, both 50 and 100 packs
- 3 adjusting springs hold on to the various box sizes



Work Gloves

Ansell

HYFLEX® 11-727R

Cut and High Abrasion Resistant Gloves

- Excellent flexibility and fit with high levels of cut protection
- ANSI Level 4 abrasion protection
- An ultralight fabric and tailored-to-hand fit, creates the sensation of bare hand comfort
- Soft ultralight-duty seamless liner breathes to keep hands cool and dry

Item #	Size	
ANS-11727R00L	Large	\$12.05
ANS-11727R0XL	X-Large	\$12.05



Winter Performance Gloves

- Waterproof and windproof layer
- The cold weather work gloves are designed to stay warm with 60g of insulation
- Durable reinforced layer between the thumb and index finger
- SMARTSWIPE™ knuckle allows you to use touch screens without removing your gloves
- Terry cloth sweat wipe
- Nylon pull



Item #	Size	
MLW-48-73-0030	Small	\$38.95
MLW-48-73-0031	Medium	\$38.95
MLW-48-73-0032	Large	\$38.95
MLW-48-73-0033	X-Large	\$38.95
MLW-48-73-0034	XX-Large	\$38.95



ANSI Cut Level 3

Winter Dipped Gloves

- Insulated work gloves are designed to provide ultimate warmth, all-day comfort, and best in class dexterity for handling small objects
- Breathable and comfortable glove design
- ANSI 3; EN511: 02X; EN 388: 2442C
- Sandy latex finish for grip performance
- 3/4 double dipped latex palm microfinish for water resistance and warmth
- 15 Gauge for better dexterity
- 7GA inner liner for warmth



Item #	Size	
MLW-48-22-8920	Small	\$13.65
MLW-48-22-8921	Medium	\$13.65
MLW-48-22-8922	Large	\$13.65
MLW-48-22-8923	X-Large	\$13.65
MLW-48-22-8924	XX-Large	\$13.65



Free-Flex Work Gloves

- Smartswipe™ touchscreen compatible fingertips, knuckles and palms
- High dexterity finger tips
- Breathable lining provides all day comfort
- Reinforced thumb seam
- Free-Flex elastic cuff
- Built-in terry cloth sweat wipe



Item #	Size	
MLW-48-22-8715	Small	\$16.15
MLW-48-22-8711	Medium	\$16.15
MLW-48-22-8712	Large	\$16.15
MLW-48-22-8713	X-Large	\$16.15
MLW-48-22-8714	XX-Large	\$16.15



Performance Gloves

- Ultimate durability and all day comfort
- Smartswipe™ touchscreen compatible fingertips, knuckles and palms
- High dexterity finger tips
- Breathable lining provides all day comfort
- Reinforced thumb seam
- Secure Velcro® closure
- Built-in terry cloth sweat wipe

Item #	Size	
MLW-48-22-8725	Small	\$15.05
MLW-48-22-8721	Medium	\$15.05
MLW-48-22-8722	Large	\$15.05
MLW-48-22-8723	X-Large	\$15.05
MLW-48-22-8724	XX-Large	\$21.65



Leather Performance Gloves

- Touchscreen compatible knuckles
- Durable palm with a lightweight design
- Breathable lightweight back
- Secure Velcro® closure
- Built-in terry cloth sweat wipe

Item #	Size	
MLW-48-73-0020	S	\$29.65
MLW-48-73-0021	M	\$29.65
MLW-48-73-0022	L	\$29.65
MLW-48-73-0023	XL	\$29.65
MLW-48-73-0024	XXL	\$29.65



Impact Resistant Goatskin Leather Gloves

- Top grain goatskin leather for maximum comfort and performance
- Reinforced palm
- Keystone thumb for mobility
- Cut resistance: ANSI level 5 rated
- Impact resistance: ANSI/ISEA level 2 rated

Item #	Size	
MLW-48-22-8780	Small	\$42.75
MLW-48-22-8781	Medium	\$42.75
MLW-48-22-8782	Large	\$42.75
MLW-48-22-8783	X-Large	\$42.75
MLW-48-22-8784	XX-Large	\$42.75



Work Gloves

FastFit® Easy On/Off Elastic Cuff Gloves

- Cool and comfortable
- Stretch-elastic cuff
- Reinforced thumb and index finger
- High-dexterity synthetic leather infused with touchscreen technology
- Machine washable



MFF-02



MFF-05

Item #	Size	
MCX-MFF-02-009	Medium	\$24.25
MCX-MFF-02-010	Large	\$24.25
MCX-MFF-02-011	X-Large	\$24.25
MCX-MFF-02-012	XX-Large	\$24.25
MCX-MFF-05-009	Medium	\$24.25
MCX-MFF-05-010	Large	\$24.25
MCX-MFF-05-011	X-Large	\$24.25
MCX-MFF-05-012	XX-Large	\$24.25

The Original® Work Gloves

- Form-fitting TrekDry® helps keep hands cool and comfortable
- Adjustable Thermoplastic Rubber (TPR) closure
- Reinforced thumb and index finger
- Touchscreen-capable synthetic leather
- Machine washable



MG-02



MG-05

Item #	Size	
MCX-MG-02-009	Medium	\$34.35
MCX-MG-02-010	Large	\$34.35
MCX-MG-02-011	X-Large	\$34.35
MCX-MG-02-012	XX-Large	\$34.35
MCX-MG-05-009	Medium	\$34.35
MCX-MG-05-010	Large	\$34.35
MCX-MG-05-011	X-Large	\$34.35
MCX-MG-05-012	XX-Large	\$34.35

M-Pact® Impact Resistant Gloves

- Thermoplastic Rubber (TPR) impact protection and finger protection
- Adjustable Thermoplastic Rubber (TPR) closure
- Breathable TrekDry® keeps hands cool and comfortable
- Touchscreen capable synthetic leather
- Reinforced palm, index finger and thumb
- Palm padding • Machine washable



Item #	Size	
MCX-MPT-52-009	Medium	\$47.45
MCX-MPT-52-010	Large	\$47.45
MCX-MPT-52-011	X-Large	\$47.45
MCX-MPT-52-012	XX-Large	\$47.45

M-Pact® Covert Tactical Impact Gloves

- Same features as M-Pact® Series, but with 0.8mm synthetic leather



Item #	Size	
MCX-MPT-55-009	Medium	\$47.45
MCX-MPT-55-010	Large	\$47.45
MCX-MPT-55-011	X-Large	\$47.45
MCX-MPT-55-012	XX-Large	\$47.45

Coveralls

By/Par
AlphaTec **Ansell**

1500 - Model 101 - Protective Coverall

- **Applications:** General maintenance, asbestos related work, handling powders, construction, chemical products
- **Protection:** Particle-filtering SMS protective suit filters 100% of particles over 3 microns, Type 5/6 protection
- **Suit features:** Stitched seams, 3-piece hood, elasticated hood, wrists, waist and ankles, 2-way front zipper with re-sealable storm flap
- **Comfort:** Breathable, air and water vapor permeability
- Silicone-free design



Item #	Size	
ANS-WH15-S-92-101-03	Medium	\$7.85
ANS-WH15-S-92-101-04	Large	\$7.85
ANS-WH15-S-92-101-05	X-Large	\$7.85
ANS-WH15-S-92-101-06	XX-Large	\$7.85

Other sizes available upon request

1800 STANDARD - Model 111 - Protective Coverall

- **Applications:** General maintenance, food, paint spraying, powder handling
- **Protection:** Low hazard liquid spray and fine particulates
- **Suit features:** Bound seams, 3-piece hood, elasticated hood, wrists, waist and ankles, 2-way front zipper with re-sealable storm flap
- **Comfort:** Breathable, moisture vapor permeable
- Silicone-free design, anti-static



Item #	Size	
ANS-WH18-B-92-111-03	Medium	\$10.45
ANS-WH18-B-92-111-04	Large	\$10.45
ANS-WH18-B-92-111-05	X-Large	\$10.45
ANS-WH18-B-92-111-06	XX-Large	\$10.45

Other sizes available upon request

1800 COMFORT - Model 195 - Protective Coverall

- **Applications:** Composites, general maintenance, paint spraying, surface prep
- **Protection:** Low hazard liquid chemicals and fine particulates, Type 5/6 protection
- **Suit features:** Bound seams, blue SMS hood, full back and underarms, 3-piece hood, elasticated hood, wrists, waist and ankles, 2-way front zipper with re-sealable storm flap, finger loops
- **Comfort:** Breathable, air & moisture vapor permeable
- Silicone-free, anti-static, low linting



Item #	Size	
ANS-WN18-B-92-195-03	Medium	\$11.75
ANS-WN18-B-92-195-04	Large	\$11.75
ANS-WN18-B-92-195-05	X-Large	\$11.75
ANS-WN18-B-92-195-06	XX-Large	\$11.75

Other sizes available upon request

2300 STANDARD - Model 111 - Protective Coverall

- **Applications:** Oil and gas, life sciences, machinery and equipment, chemical, food processing, utilities
- **Protection:** Numerous inorganic liquid chemicals, acids and bases, Type 5/6 protection
- **Suit features:** Bound seams, 3-piece hood, elasticated hood, wrists, waist and ankles, 2-way front zipper with re-sealable storm flap, finger loops
- **Comfort:** Lightweight and durable
- Anti-static



Item #	Size	
ANS-YY23-B-92-111-03	Medium	\$19.65
ANS-YY23-B-92-111-04	Large	\$19.65
ANS-YY23-B-92-111-05	X-Large	\$19.65
ANS-YY23-B-92-111-06	XX-Large	\$19.65

Other sizes available upon request

Pressure Washers

Electric Pressure Washers - Cold Water

- Automatic Start/Stop System



Item #	BEP-P1715EN	BEP-P2115EN	BEP-P2314EN
Series	Workshop	Workshop	Workshop
PSI	1,700 psi	2,150 psi	2,300 psi
Motor	1.2 HP, 120V	1.5 HP, 120V	1.6 HP, 120V
Max. Flow	1.7 GPM	1.6 GPM	1.7 GPM
Hose	20 ft.	25 ft.	25 ft.
Accessories	Spray Wand, 15° High Pressure Nozzle, Soap Foam Cannon	Spray Wand, 15°, 25° High Pressure Nozzles, Rotary Turbo Nozzle, Soap Foam Cannon	0°, 25°, Soak, Turbo Nozzles & Lance
Weight	20 lbs	35 lbs	45 lbs
	\$195.95	\$307.55	\$390.65



P1715EN



P2115EN

PORTABLE



P2314EN

Gas Pressure Washers - Cold Water



Item #	BEP-BE276RA	BEP-X-2565HWCOM	BEP-X-2565HWGENSP	BEP-X-4013HWA
Series	Workshop	Commercial	Xstream	Commercial
PSI	2,700 psi	2,700 psi	2,500 psi	4,000 psi
Engine	208cc, Powerease	196cc, Honda	196cc, Honda	389cc, Honda
Max. Flow	2.5 GPM	3.0 GPM	3.0 GPM	4.0 GPM
Hose	25 ft.	25 ft.	50 ft.	50 ft.
Accessories	Spray Gun & Lance	Spray Gun & Lance	Spray Gun & Lance	Spray Gun & Lance
Weight	80 lbs	100 lbs	110 lbs	150 lbs
	\$516.55	\$1210.05	\$1542.55	



BE276RA



X-2565HWCOM



X-2565HWGENSP



X-4013HWA

Electric Wall Mounted Pressure Washers

- Cold water:
Models X-1520FW1ARH and X-2050FW1A
- Hot water capable:
Model X-1520FW1GENH



Item #	BEP-X-1520FW1ARH	BEP-X-1520FW1GENH	BEP-X-2050FW1A
Series	Commercial	Commercial	Commercial
PSI	1,500 psi	1,500 psi	2,000 psi
Motor	2 HP, 110V - 1 Phase, 17.3A	2 HP, 110V - 1 Phase, 17A	5.0 HP, 230V - 1 Phase, 23A
Max. Flow	2.0 GPM	2.0 GPM	4.0 GPM
Hose	50 ft.	50 ft.	50 ft.
Accessories	36" Gun / Wand / Couplings	36" Gun / Wand / Couplings	36" Gun / Wand / Couplings
Plug	Nema 5-20P 20A	Nema 5-20P 20A	230V Twistlock
Weight	130 lbs	130 lbs	180 lbs



X-1520FW1ARH / X-1520FW1GENH



X-2050FW1A

Pressure Washers

BE

Hot Water Pressure Washer – Oil/Diesel Fired

ENGINE:

- 12V electric start engine with 18 A charge

COMPONENTS:

- Adjustable thermostat up to 93°C / 200°F with illuminated rocker switch
- Hour/Tach meter • 12" Oil drain hose

UNIT INCLUDES:

- Detergent injector
- 36" Pressure insulated lance
- Professional-grade insulated trigger gun/wand assembly with safety lock-off
- Quick connect nozzles: 0°, 15°, 25° and 40°
- 50-ft. x 3/8" braided hose with quick connects



Item #	GPM	PSI	CC's	BTU/Hour	(L x W x H)	Ship Weight
BEP-HW4013HG	4	4,000	389	330,000	47" x 31" x 50"	580 lbs

BE

Hot Water Pressure Washer – Electric Driven/Diesel Fired

FUEL TYPE: No. 1 or No. 2 grade Fuel Oil, Diesel or Kerosene

UNIT INCLUDES:

- Detergent injector • 36" Pressure insulated lance
- Professional-grade insulated trigger gun with safety lock-off
- Quick connect nozzles: 0°, 15°, 25° and 40°
- 50-ft. x 3/8" steel wire-braided high pressure hose with quick connects



20 Amp
Nema 6-20P

Item #	GPM	PSI	Motor	Phase	Amps	BTU/Hour	Pump	(L x W x H)	Ship Weight
BEP-HW204EMD	3	2,000	4.0 HP 240V	Single	16	207,000	Triplex	43" x 30" x 37"	439 lbs

Generators



Receptacles Guide

- A** DC 12V 8A
- B** 120V 20A
- C** 120V 30A
- D** 120V/240V 30A
- E** 120V/240V 50A

Generators

- Easy access, weather-protected outlets
- LED floodlight • Sub-zero technology • Automatic CO detector
- Warranty: - Engine: 2 years Basic / 5 years Registered
- Electronics: 1 year

Item #	BEP-BE3800	BEP-BE4800	BEP-BE7000	BEP-BE9000	BEP-BE11000	BEP-BE12500T
Max. Watt Output	3,800 Watt	4,800 Watt	7,000 Watt	9,000 Watt	11,000 Watt	12,500/11,000/9,000 W (Gas/LPG/NG)
Running Watt Output	3,000 Watt	3,800 Watt	5,500 Watt	6,500 Watt	7,500 Watt	9,500/8,500/7,500 W (Gas/LPG/NG)
Engine	212cc, Powerease	323cc, Powerease	312cc, Powerease	389cc, Powerease	420cc, Powerease	458cc, Powerease
Fuel Type	Gas	Gas	Gas	Gas	Gas	Gas / Liquid Propane / Natural Gas
Fuel Capacity	15L (3.9 Gal)	15L (3.9 Gal)	20L (5.3 Gal)	25L (6.6 Gal)	25L (6.6 Gal)	25L (6.6 Gal)
Approximate Run Time @ 1/2 Load	13.8 hours	11 hours	13.3 hours	8 hours	14.4 hours	8 hours
Start Type	Recoil	Recoil	Recoil	Recoil	Electric / Recoil	Electric / Recoil
Receptacle Types	B 4x 120V 20A C 1x 120V 30A	B 4x 120V 20A D 1x 120V/240V 30A	A 1x DC 12V 8A B 6x 120V 20A D 1x 120V/240V 30A	A 1x DC 12V 8A B 6x 120V 20A D 1x 120V/240V 30A	A 1x DC 12V 8A B 6x 120V 20A D 1x 120V/240V 30A	A 1x DC 12V 8A B 4x 120V 20A D 1x 120V/240V 30A E 1x 120V/240V 50A
Li-Ion Battery	✗	✗	✗	✗	✓	✓
dBA Rating	71 dBA	70 dBA	69 dBA	67 dBA	73 dBA	73 dBA
Ship Weight	105 lbs	116 lbs	150 lbs	193 lbs	202 lbs	207 lbs

NEW

Inverter Generators



BE2800i BE4000i BE4700iD BE7500iD BE10500iD

Inverter Generators

- Produces clean energy that is needed for sensitive electronics
- Sound dampening shell • Easy access, weather-protected outlets
- LED floodlight • Sub-zero technology • Automatic CO detector
- Warranty: Engine Basic 2 years / Engine Registered 5 years / Electronics 1 year



Receptacles Guide

- A** DC 12V 8A
- B** 120V 20A
- C** 120V 30A
- D** 120V/240V 30A
- E** 120V/240V 50A
- U** USB A & C

Item #	BEP-BE2800I	BEP-BE4000I	BEP-BE4700iD	BEP-BE7500iD	BEP-BE10500iD
Max. Watt Output	2,800 Watt	4,000 Watt	4,700 / 4,100 W (Gas/LPG)	7,500 / 6,000 W (Gas/LPG)	10,500 / 9,500 / 8,400 W (Gas/LPG/NG)
Running Watt Output	2,500 Watt	3,200 Watt	3,600 / 3,200 W (Gas/LPG)	6,000 / 5,500 W (Gas/LPG)	8,500 / 8,000 / 6,800 W (Gas/LPG/NG)
Engine	145cc, Powerease	145cc, Powerease	160cc, Powerease	312cc, Powerease	458cc, Powerease
Fuel Type	Gas	Gas	Gas / LP	Gas / LP	Gas / LP / NG
Fuel Capacity	3.6L (1 Gal)	3.6L (1 Gal)	5.8L (1.5 Gal)	12.5L (3.3 Gal)	26L (6.8 Gal)
Approx. Run Time @ 1/2 Load	3 hours	3 hours	3.8 hours	7.2 hours	9 hours
Start Type	Recoil	Recoil	Electric / Recoil	Electric / Recoil	Electric / Recoil
Receptacle Types	B 4x 120V 20A A 1x DC 12V 8A	B 4x 120V 20A A 1x DC 12V 8A	A 1x DC 12V 8A B 4x 120V 20A C 1x 120V 30A	A 1x DC 12V 8A B 4x 120V 20A D 1x 120V/240V 30A U 1x USB A & C	A 1x DC 12V 8A B 4x 120V 20A D 1x 120V/240V 30A E 1x 120V/240V 50A
Li-Ion Battery	X	X	✓	X	X
dBA Rating	63 dBA	63 dBA	63 dBA	65 dBA	67 dBA
Ship Weight	52 lbs	56 lbs	69 lbs	136 lbs	297 lbs

MLW-MXF002-2XC **\$2998⁹⁵** MX FUEL™ Carry-On™ Power Supply with Inverter Technology

- Peak/running Watts: 3,600W/1,800W
- Pure sine wave for sensitive electronics
- Push button start
- (2) 120V 15A outlets
- Ideal for 1-2 users
- Safe and quiet to use in indoors
- Lockable battery bays
- Sound level: 60 dBA
- Weight: 50 lbs • Dim.: 15" L x 12" W x 21" H
- (2) MX FUEL™ XC406 battery packs (MXFXC406)
- (1) Detachable charging cord
- 2-Year warranty



MLW-2845-20 **\$721¹⁵**

M18™ Carry-On™ Power Supply

- Delivers 3600W/1800W for aggressive 15A applications with (4) M18™ batteries (sold separately)
- Run demanding tools like table saws, compressors, and pipe threaders
- Pure sine wave inverter protects sensitive electronics
- Integrated 3A standard simultaneous M18™ charger
- Sound level: 66 dBA
- Weight: 28 lbs • Dim.: 15" L x 12" W x 14" H
- 3-year warranty



Portable and Quiet Power Generators with Inverter Technology

- Pure sine wave inverter
- Excellent source of power for emergencies, tailgating and camping, safe for indoor use
- Digital display with On/Off button
- DC output ports for charging electronic devices
- Ultra bright LED light with SOS mode
- Rechargeable Li-Ion internal battery
- AC charging adapter

Item #	SHM-SL1460	SHM-SL1466	SHM-SL1467
Capacity	330 Wh	535 Wh	880 Wh
Peak Watts	400 Watts	1,000 Watts	2,000 Watts
Running Watts	200 Watts	500 Watts	1,000 Watts
110V AC Outlets	2	2	2
USB Port 2.4A	3	3	3
USB Port 3.0A	1	1	1
DC Output Ports (12V DC, 10A Max.)	2	2	2
12V DC Port	1	1	1
	\$659.25	\$874.25	



Fans



Shop Fans

- 120 Volts, 60 Hz
- Durable black powder coated finish
- Even air flow and quiet operation
- Built-in overheat protection
- UL/CUL listed



Item #	Description	Max. CFM	Speed	Blades	Motor	Output	Weight	
ATD-30324A	24" Tilting Direct Drive Drum Fan	6,937 CFM	3-Speed	3-Blade	0.17 HP	230W	33 lbs	\$266.05
ATD-30333	30" Tilting Direct Drive Drum Fan	9,120 CFM	3-Speed	3-Blade	0.5 HP	260W	52 lbs	\$752.05
ATD-30336A	36" Direct Drive Drum Fan	12,000 CFM	2-Speed	3-Blade	0.5 HP	487W	63 lbs	\$661.75
ATD-30342A	42" Belt Direct Drive Drum Fan	17,850 CFM	2-Speed	4-Blade	0.63 HP	510W	103.6 lbs	\$972.35
ATD-30348	48" Belt Direct Drive Drum Fan	21,100 CFM	2-Speed	4-Blade	0.8 HP	600W	108 lbs	\$1212.65



Pedestal and Wall Mount Fans

- 120 Volts, 60 Hz
- Durable black powder coated finish
- Energy efficient motor
- Automatic shut-off feature prevents overheating
- Even air flow and quiet operation
- UL/CUL listed

ATD-30312 **\$213¹⁵**

12" Rechargeable Tilting Drum Fan

- Fan operates with plug-in AC or DC adaptor (included), or cordless using built-in rechargeable lithium-ion battery
- Variable speed dial control
- Air velocity High/Low: 775/180 CFM
- Run time High/Low: 5.5/36 hrs
- Charging time: 3 hours
- Battery level indicator
- Includes built in USB power port for charging your mobile devices
- 16.1" x 7.3" x 14.1"



Item #	Description	Max. Height	Max. CFM	Speed	Blades	Motor	Output	Weight	
ATD-30320A	20" High Velocity Floor Fan		4,650 CFM	3-Speed	3-Blade	1/8 HP	130W	13 lbs	\$128.75
ATD-30331A	30" Wall Mount Fan		5,440 CFM	2-Speed	3-Blade	1/6 HP	210W	33 lbs	\$399.25
ATD-30334A	30" Oscillating Wall Mount Fan		5,440 CFM	2-Speed	3-Blade	1/6 HP	210W	38 lbs	\$414.85
ATD-30330A	30" Pedestal Fan with 4 Wheels	75"	7,497 CFM	3-Speed	3-Blade	1/6 HP	210W	59 lbs	\$439.75
ATD-30335A	30" Oscillating Pedestal Fan with 4 Wheels	75"	7,497 CFM	3-Speed	3-Blade	1/6 HP	210W	59 lbs	\$506.65
ATD-30332	30" Tilting Pedestal Fan with Misting Attachment and 4 Wheels	74"	6,800 CFM	3-Speed	3-Blade	1/3 HP	220W	53 lbs	\$584.65

MLW-0820-20 **\$127⁹⁵**

M12™ Mounting Fan (Bare Tool)

- 3 speed settings: High, Medium, Low
- Max. air velocity: 400 CFM, 22km/h
- 6" blade diameter
- 360° adjustable head
- Multiple mounting features:
 - Integrated magnets;
 - 2" spring-loaded clamp;
 - Keyhole hangers;
 - Pass-through holes



MLW-0886-20 **\$147⁹⁵**

18V M18™ Cordless Jobsite Fan (Bare Tool)

- Powerful airflow system circulates air over 40 feet
- 3 speed settings: High, Medium, Low
- Max. air velocity: 284 CFM, 29km/h
- Runtime: up to 17 hours on low with a M18™ REDLITHIUM™ XC 5.0 battery (sold separately)
- 120° adjustable head and 9 stopping positions
- Multiple hanging orientations
- AC adaptor included for extended run-time

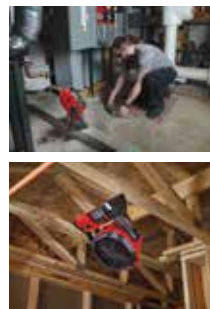

Heaters

ATD-40300 **\$175⁴⁵**
300 CFM Pro Air Blower

- 120 Volts, 60 Hz
- Variable speed switch controls motor
- Motor Speed: 900-1500 RPM
- Power Outlets: (2) 11Amp built-in grounded receptacles
- Built-in overload protection



ATD-40302 **\$92⁷⁵**
Heater Attachment for Pro Air Blower

- 1,320 Watts, 11 Amps, 5,000 BTU



MLW-0801-20C **\$297⁹⁵**
M18™ Forced Air Propane Heater

- 70,000 BTU
- Heats up to 1,700 sq. ft.
- Runs up to 8 hrs
- Includes hose and regulator
- **Propane tank, battery and charger not included**



ENR-F340662 **\$340⁹⁵**
Cordless Forced Air Propane Heater

- 27,000/68,000 BTU per hour • 300 CFM
- Heats up to 1,700 sq. ft.
- Runs 7 to 13 hrs on a 20 lb propane tank
- High temperature limit switch
- Quiet burner technology
- Hose and regulator included
- Powered by the 20V MAX® & FLEXVOLT® family of DEWALT® batteries, sold separately
- 19.75" x 12" x 18"
- **Propane tank not included**



ENR-F340640 **\$507⁰⁵**
240V Forced Air Electric Heater

- 11,260 BTU per hour
- 230 CFM • 3,300 Watts
- Heats up to 275 sq. ft.
- Equipped with a 25°F-95°F thermostat
- Minimum breaker required: 2 pole, 15A
- Single phase
- Thermostatically controlled
- Cord/plug not included
- 13.62" x 15.75" x 17.12"



ENR-F170125 **\$429⁰⁵**
Forced Air Propane Industrial Heaters

- 75,000 – 125,000 BTU/hr • 350 CFM
- Heats up to 3,000 sq. ft.
- Runs up to 11 hrs on a 40 lb propane tank
- Rugged and durable steel construction
- Economical, efficient and clean burning
- Heavy duty high output fan
- 20 ft. hose and regulator included
- Electrical rating: 115V, 3A
- #F170035 dim.: 20.75" x 9.75" x 12.75"
- #F170125 dim.: 21.25" x 11.75" x 15.75"
- **Propane tank not included**



ENR-F170275 **\$507⁸⁵**
Forced Air Kerosene Industrial Heater

- 75,000 BTU per hour
- 240 CFM
- Heats up to 1,750 sq. ft.
- Runs up to 11 hrs
- Use with kerosene #1 & #2, diesel #1 & #2, home heating oil, and JP-8
- 6-gal/23L fuel tank capacity
- Enclosed motor
- Overheat safety shutdown
- Built-in thermostat • Fuel gauge
- Electrical rating: 115V, 10A
- 32.25" x 14.25" x 17"



ENR-F232050 **\$170³⁵**
Portable Buddy Radiant Propane Heater

- 2 heat settings - 4,000/9,000 BTU per hour
- Heats up to 225 sq. ft.
- Runs 2.4 to 5.4 hours on a 1 lb disposable propane cylinder
- Runs 48 to 108 hours on a 20 lb propane tank with optional hose and filter
- One button Piezo ignition on function
- Accidental tip-over safety shut-off
- Automatic low oxygen shut-off system
- Swivel regulator
- Fold down handle
- 14.25" x 9" x 15"
- **Propane cylinder or tank not included**



ENR-F332100 **\$342¹⁵**
Cordless Radiant Propane Heater

- 6,000/12,000 BTU per hour
- Rugged handle with LED light bar
- High speed fan
- Dual 1 lb tank capacity for a 7-hr run time
- 3 USB charging ports
- Tip-over safety switch
- Oxygen Depletion System
- Powered by the 20V MAX® & FLEXVOLT® family of DEWALT® batteries, sold separately
- 15.75" x 10.5" x 14"
- **Propane tank not included**



ENR-F242100 **\$83⁹⁵**
Liquid Propane Tank Top Radiant Heater

- 10,000/12,000/15,000 BTU per hour
- Runs up to 28 hours on a 20 lb propane tank, not included
- No tool needed, hand wheel installation
- Tip-over safety shut-off
- CSA certified
- **Propane tank not included**



Vises

Professional Mechanics' Vises

IRWIN
Record.

Item #	Jaw Width	Weight	
REC-3	4"	33 lbs	\$148.85
REC-5	5"	53 lbs	\$248.55
REC-6	6"	70 lbs	\$306.65
REC-8ZR	8"	84 lbs	\$365.05



Multi-Purpose Vise with Pipe Jaw

- 360° swivel base
- Anvil work surface

Item #	Jaw Width	Weight	
ECL-EMPV-5	5"	33 lbs	\$191.25



ECLIPSE

Mechanics' Vises

ECLIPSE

Item #	Jaw Width	Weight	
ECL-EMV3	4"	21 lbs	\$103.85
ECL-EMV5	5"	35 lbs	\$161.65
ECL-EMV6	6"	55 lbs	\$244.45
ECL-EMV8	8"	87 lbs	\$324.85



Swivel Bases for Eclipse Vises

Rotates the vise 360° and locks it into the required working position.

Item #	Vise Size	
ECL-EMVSB3	4"	\$26.65
ECL-EMVSB5	5"	\$35.95
ECL-EMVSB6	6"	\$52.25
ECL-EMVSB8	8"	\$63.05



Professional Shop Vises with 360° Swivel Locking Base

ATD

Item #	Jaw Width	Weight	
ATD-9305	5"	43 lbs	\$338.45
ATD-9306	6"	56 lbs	\$443.35



Swivel Bench Vise with Pipe Jaw

- Pipe capacity: 1/4"-3"
- 210° swivel base • Anvil work surface

Item #	Jaw Width	Weight	
ATD-9316	6"	40 lbs	\$230.45



Wilton Shop Vises

- 360° lockable swivel base

Item #	Jaw Width	Weight	
WIL-63301	5"	30 lbs	\$360.45
WIL-63302	6"	46 lbs	\$510.95
WIL-63304	8"	70 lbs	\$768.55



WIL-10010 \$500⁴⁵ 6" ATV All-Terrain Vise™

- Fits a standard 2" hitch
- Can be mounted on a bench or trailer with the included mounting bracket
- Max. opening: 5-3/4"
- Pipe jaw cap.: 3/4" - 3"



WIL-10055 \$161⁰⁵ ATV All-Terrain Vise™ 10" Riser Block

- Fits a standard 2" hitch



WIL-11128BH \$380⁰⁵ B.A.S.H.® Utility Vise and Hammer Combo

- 6.5" vise includes swivel base and built-in pipe jaws
- 4 lb sledge hammer with a 12" handle



Clamps

WIL-11114 \$196⁴⁵ Spark-Duty 400CS Hi-Vis C-Clamp Kit

- Max. opening capacity: 2", 4", 6", 8"

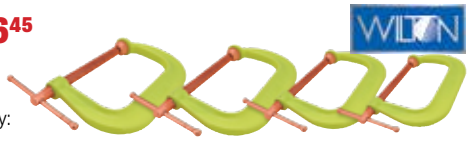

ECLIPSE

Bar Clamps & Spreaders

- Average clamping force: 300 lbs
- Throat depth: 3-3/8" (85mm)



Item #	Clamp Cap.	Spread Cap.	
ECL-EOHBC6	6" (150mm)	6-5/8" - 13-3/8" (168-340mm)	\$28.65
ECL-EOHBC12	12" (300mm)	6-5/8" - 19-1/2" (168-495mm)	\$31.65
ECL-EOHBC18	18" (450mm)	6-5/8" - 25-3/8" (168-645mm)	\$36.55
ECL-EOHBC24	24" (600mm)	6-5/8" - 31-1/2" (168-800mm)	\$37.75
ECL-EOHBC36	26" (900mm)	6-5/8" - 43-7/8" (168-1114mm)	\$44.65

Heavy Duty Metal-Working Clamps

- Clamping force: up to 1,200Kgf
- Throat depth: 5-1/2" (140mm)

Item #	Clamp Capacity	
ECL-EC-GS12	12" (300mm)	\$100.45
ECL-EC-GS16	16" (400mm)	\$107.65
ECL-EC-GS20	20" (500mm)	\$113.75
ECL-EC-GS24	24" (600mm)	\$120.15



Presses & Accessories

TOBEQ™ Professional Workshop Presses

- Fully welded construction for exceptional strength and durability
- Double speed pump with built-in safety overload valve
- Large pressure gauge filled with glycerin for easy reading
- Polycarbonate guard provides maximum protection and clear view
- 15 and 20-Ton presses delivered with a V-block set
- 30, 50, 75 and 100-Ton presses delivered with a pin set and a V-block set



On all TOBEQ™ Workshop Presses

Item #	Cap.	Press	Min./Max. Work Height	Ram Stoke	Press Bed D x W	Weight
TBQ-SP15000	Bench Press 15-Ton	Hydr.	6-5/16" x 18-1/8" (160.5 x 461mm)	6-1/4" (160mm)	4-3/4" x 19-11/16" (120 x 500mm)	168 lbs (76 kg)
TBQ-SP20000	20-Ton	Hydr.	12-1/2" x 47-3/16" (318 x 1198mm)	7-1/4" (185mm)	5-3/16" x 20-1/16" (132 x 510mm)	238 lbs (108 kg)
TBQ-SP30000	30-Ton	Hydr.	16-1/16" x 50-11/16" (408 x 1288mm)	6-11/16" (170mm)	5-1/2" x 21-1/16" (140 x 535mm)	416 lbs (188.5 kg)
TBQ-SP50000	50-Ton	Hydr.	14-15/16" x 53-1/2" (379 x 1359mm)	7-7/8" (200mm)	8-1/8" x 28-3/4" (207 X 730mm)	687 lbs (311.5 kg)
TBQ-SP75000	75-Ton	Air/ Hydr.	18-7/16" x 46-9/16" (468 x 1182mm)	9-13/16" (250mm)	8-9/16" x 31-1/2" (217 x 800mm)	1098 lbs (498 kg)
TBQ-SP100000	100-Ton	Air/ Hydr.	18-1/2" x 46-1/16" (470 x 1170mm)	11-13/16" (300mm)	10-9/16" x 31" (268 x 787mm)	1689 lbs (766 kg)



Workshop Presses

- 2 step stroke system: full stroke for quick approach or small stroke for fine tuning of the load
- Large gauge measures short and metric tons

Models 86151/86201: Delivered with protection cage and 2 V blocks

Models 86301/86501/86751/86101

- Delivered with protection cage, 2 V blocks, a quick chuck and 8 punches



On all CP™ Workshop Presses

Item #	Capacity	Press	Weight	Overall Dim. H x W x D
CPT-86151	Compact Bench Press 15-Ton	Hydraulic	166 lbs	35" x 28" x 21"
CPT-86201	20-Ton	Hydraulic	232 lbs	70" x 29" x 28"
CPT-86301	30-Ton	Hydraulic	368 lbs	70" x 31" x 28"
CPT-86501	50-Ton	Hydraulic	657 lbs	72" x 41" x 32"
CPT-86751	75-Ton	Air/Hydraulic	1,098 lbs	72" x 45" x 32"
CPT-86101	100-Ton	Air/Hydraulic	1,689 lbs	72" x 47" x 35"



MUK-432 650 **\$777⁷⁵**
Universal Workshop Press Support

- Makes the shop press safe and easy to use
- Creates three points of contact for stability and is infinitely adjustable to fit irregularly shaped objects

Drill Presses



MLW-2787-22HD **\$3498⁹⁵**

M18 FUEL™ 1-1/2" Magnetic Drill Kit

- Magnetic base with up to 2,000 lbs of holding force
- 2-speed: 400/690 RPM
- Stroke length: 5-3/4"
- Motor head adjustment: 5-1/8"
- Auto-stop lift-off detection
- (2) M18™ High Output™ XC8.0 batteries
- (1) M18™ & M12 multi-voltage rapid charger



MLW-4272-21

1-5/8" Electromagnetic Drill Kit

- 13 Amp motor
- 2-speed: 475/730 RPM
- Stroke length: 5-3/4"
- Drill point pressure: 600 lbs
- Auto-stop lift-off detection



SUN-5000A **\$988²⁵**
16 Speed Floor Drill Press

- Heavy duty 3/4 HP motor
- 5/8" drill capacity



ECL-EDPV-4 **\$46⁵⁵**
4" Drill Press & Pillar Drill Vice



Bench Grinders

SUNEX[®]
TOOLS

SUN-5002A **\$401³⁵**

8" Bench Grinder with Light

- 3/4 HP
- 5.0A
- Has two grit wheels: coarse 36 and medium 60
- 3,450 RPM



DEWALT

Bench Grinders

- Includes: 36 and 60 grit wheels



Item #	Wheel Size	Motor	Amps	
DEW-DW756	6"	5/8 HP	4.0 Amps	\$178.25
DEW-DW758	8"	3/4 HP	4.2 Amps	\$247.55

ATD

Bench Grinders

- Adjustable shatter resistant eye shields: (1) magnifying and (1) standard
- Has two grit wheels: coarse 36 and medium 60
- 3,450 RPM



Item #	Wheel Size	Motor	Amps	
ATD-10556	6"	1/2 HP	2.8 Amps	\$257.15
ATD-10558	8"	3/4 HP	4.8 Amps	\$315.25

ATD

ATD-10557 **\$195⁴⁵**

Bench Grinder Stand

- Use with most 5"-10" bench grinders
- Height: 32"



SUNEX[®]
TOOLS

SUN-5003 **\$186²⁵**

Bench Grinder Stand

- Use with Sunex #5001A & #5002A and other 6" or 8" bench grinders
- Height: 26.38"



Head Light Aligners

SYMTECH
CORPORATION
Safety by Design

SYM-01010000

Model SCA 1 – Visual Optical Headlamp Aligner with ISO Colour

- Fast and simple headlamp alignment
- Compact and portable
- Adjustable height
- Laser floor slope measurement
- Accurate and repeatable alignment
- Rotational mast



SYM-03010000

Model CVA 3EZ – Visual Optical Headlamp Aligner with Visual Assist Meter & ISO Colour

- Revolutionary, easy-to-use system
- Visual assist meter makes alignment precise, fast and simple
- Beam pattern selection
- Alignment instructions printed on optical head for quick reference
- Laser floor slope measurement
- Rotational mast



SYM-06010000

Model DVA 6 – Camera-Based Electronic Headlamp Alignment System

- Aligns all lamp patterns: SAE, VOR, VOL, Euro
- Aligns all lamp types: Halogen, Xenon, HID, LED
- LCD colour touch screen
- Line laser vehicle alignment
- Laser centering on headlamp
- Laser floor slope measurement
- Multi-Bay usage and floor slope recording
- RS232, Ethernet, Wi-Fi, Bluetooth capable
- Optional printer available



FULL PRODUCT LINES AVAILABLE!

Please call your Dealer to inquire about all products & prices.

RIDGID

ridgid.com



GREENLEE

greenlee.com

Extension Cords & Cord Reels

REELCRAFT Made in USA



L 4050 163 3
L 4545 123 3

L 4545 123 7

L 4545 123 9

Retractable Indoor Extension Cord Reels

- Grounded outlets
- UL listed at 125V 60 Hz single phase

Item #	Cord	Outlets	Amps	
RFT-L 4050 163 3	50 ft. – 16/3 SJTOW	Single	13A	\$706.95
RFT-L 4545 123 3	45 ft. – 12/3 SJE00W	Single	15A	\$777.15
RFT-L 4545 123 7	45 ft. – 12/3 SJE00W	Duplex Outlet Box with GFCI	15A	\$907.05
RFT-L 4545 123 9	45 ft. – 12/3 SJE00W	Triple Tap	15A	\$808.55

BAYCO



SL-800

SL-8903



SL-8906

Retractable Extension Cord Reels

- Grounded outlets

Item #	Description	Cord	Outlets	Amps	
BAY-SL-800	Metal Cord Reel	30 ft. – 16/3 SJT	3	10A	\$132.05
BAY-SL-8903	Polymer Cord Reel	50 ft. – 14/3 SJTW	3	13A	\$237.25
BAY-SL-8906	Polymer Cord Reel, All-Weather Cord	50 ft. – 12/3 SJE0W	4	15A	\$408.75

ALERT

5020TF-4C



5320T-SW
5330M-SW



5000A-30GF-CB



5000M-30GF-CB



8140T-P

Retractable Extension Cord Reels

- Grounded outlets
- Resettable circuit breaker
- Power ON indicator light



8645TFI



8150MP



8665TFS



8665TFQ



8675MFT

Item #	Length	Gauge	Outlets	Watertight Connector	Max. Rating	Usage	Housing	
ALT-5020TF-4C	20 ft.	SJTOW 12/3	4		1875W, 15A	Indoor	Steel	\$190.05
ALT-5320T-SW	20 ft.	SJT00W 12/3	1	NEMA 5-15C	1875W, 15A	Indoor/Outdoor	Thermoplastic	\$547.95
ALT-5330M-SW	30 ft.	SJT00W 14/3	1	NEMA 5-15C	1625W, 13A	Indoor/Outdoor	Thermoplastic	\$500.55
ALT-5000A-30GF-CB	30 ft.	SJT 16/3	3		1250W, 10A	Indoor	Steel	\$132.65
ALT-5000M-30GF-CB	30 ft.	SJTW 14/3	3		1625W, 13A	Indoor	Steel	\$151.35
ALT-8140T-P	40 ft.	SJTOW 12/3	3		1875W, 15A	Indoor	Thermoplastic	\$267.35
ALT-8645TFI	45 ft.	SJTOW 12/3	1		2500W, 20A	Indoor	Thermoplastic	\$373.55
ALT-8150MP	50 ft.	SJTOW 14/3	3		1625W, 13A	Indoor	Thermoplastic	\$253.25
ALT-8665TFS	65 ft.	SJTOW 12/3	1		2500W, 20A	Indoor	Thermoplastic	\$374.45
ALT-8665TFQ	65 ft.	SJTOW 12/3	4		1875W, 15A	Indoor	Thermoplastic	\$385.35
ALT-8675MFT	75 ft.	SJTOW 14/3	3		1250W, 10A	Indoor	Thermoplastic	\$356.95

Extension Cords & Cord Reels



Extension Cord Reels

- Lighted triple tap outlet
- Circuit breaker with reset button
- Oil, water and sunlight resistant cord, remains flexible in low temperatures
- Swivel mounting bracket
- Grounded plug includes 5 ft. lead-in cord
- cULus listed

Item #	Length	Gauge	Max. Rating	
LEG-FZ8160253	25 feet	16/3 SJTOW	1250W, 10A	\$170.75
LEG-FZ8140503	50 feet	14/3 SJTOW	1625W, 13A	\$263.55
LEG-FZ8120603	60 feet	12/3 SJTOW	1875W, 15A	\$362.85

Flexzilla® Pro Reel with Self-Leveling System



Outdoor Extension Cords

- Extreme all-weather flexibility (-58°F to 140°F)
- Abrasion and corrosion-resistant
- Glow-in-the-dark stripe
- Power indicator light
- Resists kinks and easy to coil
- Grounded plug
- cULus listed



Item #	Length	Gauge	Max. Rating	
LEG-FZ512930	50 feet	10/3 SJTW	1,875 Watt, 15A	\$222.85
LEG-FZ512830	50 feet	12/3 SJTW	1,875 Watt, 15A	\$136.85
LEG-FZ512935	100 feet	10/3 SJTW	1,875 Watt, 15A	\$428.85
LEG-FZ512835	100 feet	12/3 SJTW	1,875 Watt, 15A	\$261.55
LEG-FZ512735	100 feet	14/3 SJTW	1,875 Watt, 15A	\$173.05

Heavy Duty Indoor/Outdoor Professional Extension Cords

- 3-wire grounded cord
- Safety power GLOW plug
- Non-marring cord is oil, chemical and abrasion resistant
- Remains flexible down to -40°F
- Meets OSHA standards • cULus listed



Item #	Length	Gauge	Tap	
ATD-8002	25 feet	16/3 SJTW	Single	\$46.95
ATD-8040	25 feet	12/3 SJTW	Single	\$83.75
ATD-8041	50 feet	12/3 SJTW	Single	\$152.65

Magnets



4-Pc Mini Rubber-Coated Magnetic Holder Set

- 49mm diam. x 51mm long



Item #	Colour	
MUK-905 143/BLUE	Blue	\$70.35
MUK-905 143/NEON	Neon Green	\$70.35
MUK-905 143/ORANGE	Orange	\$70.35

Pedal Depressors



LIS-21520 **\$79⁹⁵**

Truck Pedal Depressor

- For clutch & brake pedals
- Extends from 18-1/2" to 34-1/2"

Hood Props



LIS-45900 **\$81²⁵**

Hood Prop

- Telescopes from 18-1/2" to 46-3/4"



VIM-V389 **\$114²⁵**

78" Lift Gate / Hood Prop

- Adjustable length from 36" to 78"



TEX-939 **\$24²⁵**

Professional Magnetic Universal Hood/Tailgate Strut Rod Lock

- Fits strut rods up to 9/16" in diameter
- Magnet allows for one-handed application
- Securely attaches to strut rod and holds hood, trunk or tailgates in place
- Can be used to change strut rods on vehicles with two strut rods



Tire Steps



400 Lbs Capacity Heavy Duty Portable Tire Steps

- Folds for compact storage (less than 4")

Item #	Tire Size	
ESC-60202	Super Single	\$100.05
ESC-60203	22.5"-24.5"	\$123.15

ATD-10310 **\$155⁷⁵**

400 Lbs Capacity Heavy-Duty Truck Tire Step

- Ideal for working on your truck, van or SUV
- Folds flat for easy storage
- Width: 28"
- Height: 13"



Hand Trucks



APP-3489 **\$169⁰⁵**

Cart-N-Box 800 Lbs Capacity Collapsible Hand Truck

- Heavy gauge steel tubing
- High quality 10" pneumatic tires
- 32" x 14.5" x 8"
- Weight: 24 lbs
- 10 year warranty on frame, 1 year warranty on tires



MLW-48-22-8415 **\$318⁹⁵**

PACKOUT™ 2-Wheel Cart, 400 Lbs Capacity

- Modular connectivity with ALL PACKOUT™ components: integrated PACKOUT™ mounting on the base and frame that allows you to securely stack or hang PACKOUT™ products
- Integrated long tool storage and small accessories compartments
- Impact resistant body
- 10" flat-free, in-board wheels
- Dimensions - 20" W x 12" D x 48" H

Stools & Platforms



STK-20350 **\$330¹⁵**

Pro Step Heavy Duty Stool

- Heavy-duty 500 lbs capacity
- 32" x 16" platform
- Foam bumpers protect vehicle finish
- Adjustable height: 6-1/2" to 22-1/2"



Heavy Duty Aluminum Platforms

- Maximum capacity: 330 lbs
- Lightweight, space saving design folds away for easy storage
- Anti-slip work platform
- Non-slip rubber feet on work platform for added stability

Item #	W x D x H	
ATD-9534	38" x 12" x 19-7/10"	\$262.25
ATD-10325	30-3/4" x 11-3/4" x 19-1/2"	\$213.85

Work Stands



MUK-EQ-350 **\$384⁵⁵**

88 Lb Capacity Uni-Worktable

- Built-in parts dividers and screwdriver/wrench/pry bar holders
- Top tray with protective bumpers: 31.8" x 18" x 1.6"
- 3" heavy duty casters (2 locking)
- Adjustable height: 35.4" to 48.4"



ATD-7012 **\$268⁶⁵**

Heavy Duty Mobile Work Table with Drawer

- 1" deep drawer for convenient storage
- Adjustable from 34" to 48" high
- 220 lbs capacity in center
- 29" W x 20" D x 1" H top tray designed to hold air tools, screwdrivers and pry bars



GWR-83166 **\$314⁹⁵**

Adjustable Height Mobile Work Table

- Handle can be mounted in up or down position for user comfort
- Solid solvent resistant EVA mat
- Tray includes compartments and slots for easy access to tools and small parts
- 125 pound center load capacity, 65 pounds on edges
- Bumper guards on corners
- Adjustable height: 35" to 48"



Workbenches

HOM-GW00550160 **\$1454⁴⁵**

79" Industrial Steel Workbench

- 3 drawers with high security tubular locking system
- Maximum capacity: 1,100 lbs
- 78-3/4" W x 25-1/2" D x 34" H
- Weight: 211 lbs



ATD-70325A **\$1130⁵⁵**

Heavy Duty Tear Down Table

- Max. capacity: 1,000 lbs
- Offset drain for fluid containment in the removable 3-gallon drain pan
- Lockable storage drawer
- 4" swivel casters, 2 locking
- 48" W x 31-1/2" D x 33-3/4" H
- Weight: 145 lbs



TITAN

Professional Workbenches

- Durable powder coated finish
- Weight cap.: 1,200 lbs
- 60" W x 31" D x 34" H
- Weight: 140 lbs

Item #	Colour	
TIT-21006		\$844.35
TIT-21009		\$844.35



ATD-70360 **\$810¹⁵**

Heavy Duty Workbench

- Max. cap.: 1,200 lbs
- Durable powder coated finish
- Adjustable foot pads
- 60" W x 36" H x 31" D
- Weight: 140 lbs



ATD-70320 **\$587⁹⁵**

Heavy Duty 60" Workbench

- Max. capacity: 330 lbs
- 14 gauge steel construction with powder coat finish
- Adjustable foot pads
- 60" L x 30" D x 34" H
- Weight: 99 lbs



TIT-21005 **\$64⁴⁵**

4-Pc Heavy-Duty Swivel Casters

- Load capacity: 1,200 lbs (300 lbs each)
- Wheel size: 4" x 1-3/16"
- For use with Titan #21006/#21009 Professional Workbenches



Sprayers & Cleaning Accessories



How to Choose your Solo Sprayer

The sprayer seals should be paired to the type of chemicals you are using. While buying a sprayer, remember to always consider the seal.

Nitrile/Buna

- pH scale:** Neutral fluids (pH 7)
- Uses:** Green cleaning; Deodorizing
- Product types:** General cleaners; Neutral cleaning solutions; Deodorizers; Detergents; Disinfectants

Viton®

- pH scale:** Acidic fluids (pH 1-7)
- Uses:** General cleaning; Removing rust and lime residue; Applying bleach solutions; Sanitation against germs and bacteria
- Product types:** Toilet bowl cleaners; Tub & tile cleaners; Solvents; Bleach solutions; Rust removers; Pool/spa cleaners

EPDM

- pH scale:** Alkaline fluids (pH 7-14)
- Uses:** Removing organic fats and oils; Removing protein residue; Cleaning glass; Disinfecting; Carpet spot cleaning; Degreasing
- Product types:** Multi-surface cleaners; Glass/window cleaners; Disinfectants; Carpet cleaners; Degreasers

Hand-Held Sprayers

- Built tough
- Durable, translucent, high-density polyethylene tanks are resistant against chemicals and UV rays
- Corrosion-resistant
- Refer to the chemical compatibility info to choose the right sprayer



Item #	Description	Cap.	Wand	Hose	Nozzle	
SLO-415	Pressure Sprayer for NEUTRAL FLUIDS	1 L			• Plastic adjustable nozzle	\$18.55
SLO-418	One-Handed Pressure Sprayer	1 L	3.5"		• Multi-directional	\$37.25
SLO-418-2L	One-Handed Pressure Sprayer	2 L	3.5"		• Multi-directional	\$38.35
SLO-378	Concrete Sprayer with Large Base Designed for concrete preparation and treatment as well as general spraying tasks	3 Gal	28"	48"	• 1 gpm, 110° flat fan • Plastic adjustable nozzle • Hollow cone • Jet stream	\$174.25
SLO-388	Industrial Acetone Sprayer Designed for applying acetone-based formulations, most alcohols and ammonia	3 Gal	28" brass	72"	• Brass cones: 0.2 & 0.4 gpm • Brass fan: 0.5 gpm	\$230.05
SLO-458-HD	Heavy Duty Professional All-Purpose Sprayer	3 Gal	28"	48"	• Brass Fan: 0.4 gpm • Plastic Adjust. • Hollow Cone • Jet Stream	\$172.05
SLO-430-1G-HD	Heavy Duty Sprayer Designed for medium-to-large jobs	1 Gal	28"	48"	• Brass Fan • Plastic Adjustable • Fan Spray • Hollow Cone • Jet Stream	\$100.15
SLO-430-2G-HD	Heavy Duty Sprayer Designed for medium-to-large jobs	2 Gal	28"	48"	• Brass Fan • Plastic Adjustable • Fan Spray • Hollow Cone • Jet Stream	\$104.55
SLO-430-3G-HD	Heavy Duty Sprayer Designed for medium-to-large jobs	3 Gal	28"	48"	• Brass Fan • Plastic Adjustable • Fan Spray • Hollow Cone • Jet Stream	\$117.45

Solo CLEANLine Sprayers

- Designed for cleaning and disinfection
- Durable, translucent, high-density polyethylene tanks are resistant against chemicals and UV rays
- Corrosion-resistant



Item #	Description	Cap.	Wand	Hose	Nozzle/Accessories	
SLO-301-A	One-Handed Pressure Sprayer	1.25 L			• Hollow cone adjustable nozzle	\$47.55
SLO-301-B	One-Handed Pressure Sprayer	1.25 L			• Hollow cone adjustable nozzle	\$47.55
SLO-302-A	One-Handed Pressure Sprayer	2 L			• Hollow cone adjustable nozzle	\$51.05
SLO-302-B	One-Handed Pressure Sprayer	2 L			• Hollow cone adjustable nozzle	\$51.05
SLO-305-A	Piston Pump Sprayer	1.5 Gal	20"	54"	• Flat spray nozzle • Shoulder strap	\$130.85
SLO-305-B	Piston Pump Sprayer	1.5 Gal	20"	54"	• Flat spray nozzle • Shoulder strap	\$131.25
SLO-307-A	Piston Pump Sprayer	2 Gal	20"	54"	• Flat spray nozzle • Shoulder strap	\$137.95
SLO-307-B	Piston Pump Sprayer	2 Gal	20"	54"	• Flat spray nozzle • Shoulder strap	\$145.45
SLO-315-A	Backpack Sprayer	4 Gal	20"	54"	• Shoulder strap & waist belt	\$247.65
SLO-303-FA	Pressure Sprayer with FOAMING FUNCTION	1.25 L			• Flat spray nozzle • "varioFOAM" function	\$54.65
SLO-303-FB	Pressure Sprayer with FOAMING FUNCTION	1.25 L			• Flat spray nozzle • "varioFOAM" function	\$54.65
SLO-309-FA	Piston Pump Sprayer with FOAMING FUNCTION	2.5 Gal	20"	54"	• Flat spray nozzle • Shoulder strap • "varioFOAM" foaming function	\$176.45
SLO-309-FB	Piston Pump Sprayer with FOAMING FUNCTION	2.5 Gal	20"	54"	• Flat spray nozzle • Shoulder strap • "varioFOAM" foaming function	\$182.65

Sprayers & Cleaning Accessories

ATS-95500 **\$181⁹⁵**



Tornado Turbo Cleaner

- Powerful cleaning tool with precision control
- Cleans and air dries in seconds
- Suitable for 240V compressors



Refer to the **FBS Chemical Compatibility Chart** to choose the right sprayer for your needs.

FKM/PA - Performance Compression Sprayers

- Do not use with acetone or other non-compatible chemicals

Applications:

- Wax & grease removers
- Brake & parts cleaners
- Degreasing & cleaning agents
- Surface coatings
- The 1.8L sprayer has the ability to be charged with compressed air



Item #	Capacity	
FBS-50100	1L	\$65.85
FBS-50400	1.8L	\$94.65

FBS-50201 **\$92⁴⁵**

KPV-FPV/FPE - Engine Cleaner and Degreaser Sprayer, 1L

Applications:

- Engine degreasers & cleaning agents
- Brake & parts cleaners
- Wax & grease removers
- Surface coatings



FPV/FPE - Performance Series Sprayers

Applications:

- Wax & grease removers, preconditioners
- Engine degreasers & cleaning agents
- Surface coatings
- Brake & parts cleaners, solvents, spray gun wash & much more
- Ability to be charged with compressed air



Item #	Capacity	
FBS-50300	1L	\$131.45
FBS-50404	1.8L	\$143.35

FBS-50350 **\$110¹⁵**

FPV/SPP Pump Sprayer for Acid Based Cleaners, 1L

Applications:

- Wheel & rim cleaners
- Metal & steel parts cleaners
- Aluminum cleaners & brighteners



CHA-1002 **\$28⁶⁵**

48 oz Multi-Purpose Sprayer

- Compatible with common fertilizers, weed killers and pesticides
- Adjustable nozzle
- In-tank anti-clog filter



CHA-1046 **\$51⁹⁵**

48 oz Industrial Cleaner/Degreaser

- Compatible with most industrial chemicals, also suitable for home use
- Adjustable poly and brass cone nozzles
- In-tank anti-clog filter



CHA-16200 **\$44²⁵**

2-Gallon/7.6L Home and Garden Sprayer

- Compatible with common herbicides, pesticides, fertilizers and general cleaners
- Includes: 12" wand, 34" hose
- Adjustable nozzle • In-tank filter



CHA-1949 **\$283³⁵**

3.5-Gallon/13.2L Industrial Concrete Open Head Sprayer

- Chemical-resistant seals
- 4" wide mouth opening for easy filling and cleaning
- 48" reinforced hose with threaded fittings
- 24" wand • Brass pump, wand, nozzle and shut-off with lock-on feature



TITAN

Spot Spray 32 oz Non-Aerosol Sprayers

- Not for use with paint products or flammable propellants
- 80-150 PSI



Item #	Colour	
TIT-19419	Red	\$79.75
TIT-19422	Black	\$79.75
TIT-19423	Orange	\$79.75
TIT-19424	Blue	\$79.75
TIT-19425	Green	\$79.75

SUR-A1000G **\$109⁶⁵**



32 oz Powder-Coated Industrial Steel Sprayer (Green)

- Multi-use spray nozzle sprays mist or pinstream
- For cleaners, degreasers, penetrating oils, brake cleaners, solvents etc.
- Not recommended for paint



TITAN

TIT-19426 **\$107⁷⁵**

227 ml Aluminum Spray Bottle

- Max. pressure: 116 psi
- 2 nozzles: conventional and 6.1" jet nozzle



LIS-19772 **\$14⁰⁵**

1L Industrial Sprayer

- For use with light oils, solvents and detergents



Sandblasting/Abrasive Equipment

HOMAK

HOM-RD00920250 **\$549⁸⁵**

Table Top Abrasive Cabinet

- Included light for better work visibility
- Extra PVC window protectors included
- Replaceable work gloves
- Media release plug
- 4 Ceramic nozzles included
- 23" W x 19" D x 19-1/4" H
- Weight: 42 lbs



HOM-RD00924380 **\$1341¹⁵**

Vertical Abrasive Cabinet

- Included light for better work visibility
- Extra PVC window protectors are included
- Replaceable work gloves
- Media release door
- 4 Ceramic nozzles included
- 36-5/8" W x 23-1/4" D x 52-5/8" H
- Weight: 113 lbs



Parts Washers

HOMAK

RD00820310



RD00840450

Parts Washers

- Flexible nozzle
- Solid steel design
- Fusible linked lid arm
- Electric pump with On/Off switch included
- Removable work surface tray
- Equipped with drain plug for easy cleaning
- Must use water based solvent only

Item #	Capacity	W x D x H	Weight	
HOM-RD00820310	20 Gallon	30" x 21-1/4" x 34-5/8"	58 lbs	\$490.65
HOM-RD00840450	40 Gallon	46-7/8" x 22-7/8" x 36-3/4"	99 lbs	\$755.25

ATD

Parts Washers

- Flexible spigot
- Spring loaded lid with fire link
- Parts basket and shelf
- cUL Approved 110V AC pump with 264 gal./hr. output
- Must use water based solvent only



8525



8527

Item #	Capacity	W x D x H	Weight	
ATD-8525	20 Gallon	30-1/2" x 21-1/4" x 34-5/8"	55 lbs	\$542.65
ATD-8527	40 Gallon	44-1/2" x 21-1/4" x 35"	90 lbs	\$820.35

Parts Wash Brushes

Lisle

89500



89510



Bucket Brushes

- Designed for hand use in a parts washing sink or solvent container
- Can be used in either solvent- or water based cleaning solutions

Item #	Description	
LIS-89500	ALASTA® Parts Brush	\$19.75
LIS-89510	ALASTA® Soft Tip Brush	\$21.05

Lisle

89520



89530



89540



89550



89680



Flow-Thru Brushes

- Designed for industrial parts washers with solvent circulating pumps
- Can be used in either solvent- or water based cleaning solutions

Item #	Description	
LIS-89520	ORIFLO® Flow-Thru Brush	\$25.15
LIS-89530	ORIFLO® Flow-Thru Brush with 28" Tube	\$38.05
LIS-89540	ORIFLO® Flow-Thru Soft Tip Brush	\$26.35
LIS-89550	MULTIJET® Flow-Thru Brush with an Additional Ring of Solvent Jets	\$27.65
LIS-89680	Straight Shooter #8 Flow-Thru Brush with Valve	\$39.35

BRM

PW4P



PWA



PWCST



PWAST



Parts Wash Brushes

- Superior tools with synthetic filaments for resistance to solvent cleaners

Item #	Brush Features	
BRM-PWA	Straight Handle – Flow Thru	\$50.45
BRM-PW4P	Ergonomic Handle – Flow Thru with Valve	\$80.35
BRM-PWCST	Straight Handle – Soft Tip Ideal for Wheel Cleaning	\$33.35
BRM-PWAST	Straight Handle – Soft Tip – Flow Thru Ideal for Wheel Cleaning	\$60.85

Vacuum Cleaners



MLW-0880-20 **\$148²⁵**
2-Gallon M18™ Wet/Dry Vacuum (Bare Tool)
 • 45 CFM
 • Built-in blower port
 • On-board attachments storage
 • Stackable tool box design
 • Run time: 30+ minutes on an M18™ REDLITHIUM™ 9.0 battery pack (sold separately)
 • (1) HEPA filter (49-90-1900)



MLW-0970-20 **\$278⁹⁵**
2.5-Gallon M18™ PACKOUT™ Wet/Dry Vacuum (Bare Tool)
 • 50 CFM
 • Built-in blower port
 • Run time: 30-50 minutes on a HIGH OUTPUT™ 8.0 battery pack (sold separately)
 • (1) HEPA filter (49-90-1900)



MLW-49-90-1900 **\$34⁸⁵**
HEPA Filter
 • Compatible with #0880-20 and #0970-20

MLW-0850-20 **\$108⁹⁵**
M12™ Compact Vacuum (Bare Tool)

- Creates suction for a wide range of construction materials, such as wood chips and metal shavings
- 33 CFM
- Run time: up to 29 minutes using REDLITHIUM™ XC4.0 batteries (sold separately)



MLW-0882-20 **\$177⁹⁵**
36 Oz. M18™ Compact Vacuum (Bare Tool)

- For cleanup of common jobsite debris
- 40 CFM
- Run time: up to 25 min. on a XC5.0 battery pack, and 43 min. on a HIGH DEMAND™ 9.0 battery pack (sold separately)
- (1) HEPA filter (49-90-0160)



MLW-49-90-1951 **\$25⁷⁵**
M18™ Compact Vacuum HEPA Dry Filter Kit (2-Pack)
 • Compatible with #0882-20



GOJ-QS9000R **\$86⁴⁵**
Quick Spiff™ Air Powered Vacuum
 • Safe in wet or hazardous conditions
 • Completely self-contained
 • Heavy duty, easy-empty dust bag



DEW-DCV501HB **\$145⁷⁵**
20V MAX* Dry Hand Vacuum with Accessories (Bare Tool)
 • 46 CFM
 • LED light
 • HEPA filtration
 • Belt hook



M18 FUEL™ Wet/Dry Vacuum Kits
 • Interchangeable motor heads, tanks and carts
 • Integrated accessory storage
 • **All kits include:** motor head, tank, cart (model #0930 comes with a premium cart), high efficiency filter, (2) extension wands, crevice tool, floor utility nozzle, 9 ft. flexible hose



Item #	MLW-0910-20	MLW-0920-20	MLW-0920-22HD	MLW-0930-22HD
Capacity	6-Gallon	9-Gallon	9-Gallon	12-Gallon
Peak HP	3.5 HP	4.25 HP	4.25 HP	4.25 HP
CFM	87 CFM	109 CFM	109 CFM	109 CFM
Hose Diam.	1-7/8"	1-7/8"	1-7/8"	2-1/2"
Battery	1 Battery required (not included)	2 Batteries required (not included)	2 Batteries required & included: XC8.0	2 Batteries required & included: HD12.0
Charger	Not included	Not included	M18™ dual bay rapid charger	M18™ dual bay rapid charger
	\$347.95	\$427.95	\$814.15	\$973.95

Vacuum Cleaners

RIDGID

RGD-62703 **\$208⁰⁵**
12-Gallon NXT Wet/Dry Vacuum (Model RT1200)

- 130 CFM
- 5.0 peak HP
- 9 Amp
- Blowing capacity
- Locking accessories
- Built-in oversized drain
- 15 ft. power cord
- Premium locking hose: 2.5" x 8 ft.
- (1) Standard filter



RIDGID

RGD-50338 **\$463⁴⁵**
16-Gallon Motor-On-Bottom Wet/Dry Vacuum (Model 1650RV)

- 190 CFM • 6.5 peak HP • 12A
- Blowing capacity
- Locking accessories
- Built-in oversized drain
- 20 ft. power cord
- Premium locking hose: 2.5" x 8 ft.
- (1) Fine dust filter



RIDGID

RGD-50353 **\$446¹⁵**
16-Gallon Stainless Steel Wet/Dry Vacuum (Model 1610RV)

- 187 CFM • 6.5 peak HP • 12A
- Blowing capacity • Locking accessories
- Sound reduction technology
- Accessory storage bag
- 20 ft. power cord
- Premium locking hose: 2.5" x 8 ft.
- (1) Fine dust filter



Outdoor Power Equipment

Milwaukee



MLW-2724-20 **\$252⁸⁵**
M18 FUEL™ Blower (Bare Tool)

- Power to clear from 15 ft.
- Maximum air volume: 450 CFM
- Maximum air speed: 120 MPH
- High/Low speed settings



MLW-2824-20 **\$405⁷⁵**
M18 FUEL™ Dual Battery Blower (Bare Tool)

- Maximum air volume: 600 CFM
- Maximum air speed: 145 MPH
- Nozzles: (1) flat & (1) tapered
- (2) M18™ batteries required

Milwaukee



MLW-2727-20C **\$432⁸⁵**
M18 FUEL™ 14" Chainsaw (Bare Tool)

- Cuts faster than gas and delivers up to 150 cuts per charge
- 6,600 RPM
- Reaches full throttle in under 1 second
- .043" chain gauge and 3/8" low profile chain pitch



MLW-2825-21ST **\$478⁰⁵**
M18 FUEL™ String Trimmer Kit with QUIK-LOK™

- Power head compatible with multiple QUIK-LOK™ System attachments such as the Edger, Articulating Hedge Trimmer, and Pole Saw attachments
- Cutting swath: 14" - 16"
- 0-4900 / 0-6200 RPM
- Line diameter: 0.080" / 0.095"
- (1) M18™ XC8.0 battery
- (1) M18™/M12™ rapid charger



MLW-2825-20ST **\$332³⁵**
M18 FUEL™ String Trimmer with Power Head (Bare Tool)



MLW-2727-21HD **\$667⁹⁵**
M18 FUEL™ 16" Chainsaw Kit

- Cuts faster than gas and delivers up to 150 cuts per charge
- 6,600 RPM
- Reaches full throttle in under 1 second
- .043" chain gauge and 3/8" low profile chain pitch
- Automatic oiler for chain lubrication



MLW-49-16-2749 **\$34⁰⁵**
14" Replacement Saw Chain

MLW-49-16-2715 **\$37¹⁵**
16" Replacement Saw Chain

Seat Covers & Floor Mats



JDI-ESC-2-H **\$84⁶⁵**

Economy Seat Covers

- 31.5" W x 52"L covers protect seats from dirt, dust, grease and liquids
- Thickness: 0.8 mil
- Stay in place when the technician enters and exits the car
- Strong construction won't rip or tear
- 200 sheets per box



JDI-PFM-500 **\$75⁵⁵**

Disposable Paper Floor Mats

- Designed for dry environment applications
- Measures 16" x 22"
- Box of 500

Rags & Towels



KIM-75130 **\$159¹⁵**

Scott® Shop Towels in a Roll

- Strong, durable, absorbent
- 11" x 10.4" blue sheets
- 55 sheets per roll, 30 rolls per case



KIM-75190 **\$25²⁵**

Absorbent Blue Shop Towels in a Box

- Strong, durable, absorbent
- 10" x 13" blue sheets
- 200 sheets per box



Kimberly-Clark

KIM-75260 **\$25²⁵**

Scott® Rags in a Box

- Strong, absorbent, performs like cloth
- 10" x 12" white sheets
- 200 towels

Janitorial Supplies



ZEP-M60323 **\$41⁴⁵**

Cherry Bomb Heavy-Duty Hand Cleaner with Abrasive

- Formulated to spread, capture, and hold grease
- Light cherry fragrance
- (1) 1 gal (3.78 L) bottle



35" x 50"
Anchor® Black Garbage Bags



Item #	Description	Bags/Case	
TBQ-3550S-B	Strong	125	\$32.65
TBQ-3550XS-B	Extra-Strong	100	\$36.85

TBQ-4841 **\$40⁹⁵**

Cascades PRO Select™ – Standard Toilet Paper

- 2 ply • 420 Sheets per roll
- 4.25" x 3" (10.8 cm x 7.6 cm)
- Case of 48 rolls



Cascades PRO

TBQ-F950 **\$46⁹⁵**

Cascades PRO Select™ – Flat Box Facial Tissue

- 2 ply • 100 Sheets per box
- 8.1" x 7.3" (20.8 cm x 18.7 cm)
- Case of 30 boxes



TBQ-H085 **\$43⁹⁵**

Roll Paper Towel

- 1 ply
- 100% recycled fiber
- 7-7/8" x 800 feet • 6 rolls per case



Singlefold Paper Towel

- 100% recycled fiber
- One-at-a-time dispensing
- 250 sheets per pack
- 9" x 9.45" (22.9 cm x 24 cm)
- 16 packs per case



Item #		
TBQ-H110	White	\$45.35
TBQ-H115	Natural	\$35.65



TBQ-137112 **\$12¹⁵**

Wet Floor Safety Sign, English/French

- 13" W x 11.75" L x 23.5" H



TBQ-137200 **\$27⁴⁵**

Wet Floor Small Safety Cone, English/French

- 10.5" W x 10.5" L x 26" H



TBQ-400-26800 **\$173³⁵**

Smokers CeaseFire® Cigarette Butt Receptacle – Pewter Grey



Spill Absorbents



Reteck Extra Strength Contractors Absorbent Pads - Medium Weight

- Perforated, select-your-size pads
- Quick absorption and unparalleled strength
- Choose between **OIL-ONLY** (white) absorbency or **UNIVERSAL** (oil & water, grey)

Item #	Description	Size	Quantity	
SPK-HRCXSO	PADS - Oil Only	15" x 18"	100 pads	\$74.65
SPK-HRCXSU	PADS - Universal	15" x 18"	100 pads	\$76.15
SPK-HRCXSSRO-S	ROLL - Oil Only	15" x 150 ft.	1 roll	\$94.55
SPK-HRCXSRO	ROLL - Oil Only	30" x 150 ft.	1 roll	\$185.65
SPK-HRCXSSRU-S	ROLL - Universal	15" x 150 ft.	1 roll	\$96.35
SPK-HRCXSRU	ROLL - Universal	30" x 150 ft.	1 roll	\$189.15

Reteck Absorbent Pads - Light Weight

- Perforated, size-selectable pads
- **OIL-ONLY** (white) sorbents soak-up petroleum based fluids while repelling water
- **UNIVERSAL** (grey) sorbents are designed to pick-up aggressive hydrocarbon (oil and water spills)



Item #	Description	Size	Quantity	
SPK-P200S	PADS - Oil Only	15" x 18"	100 pads	\$56.65
SPK-UP200S	PADS - Universal	15" x 18"	100 pads	\$56.25



Spill Containment Flexible Socks and Booms

- Keep fluids from spreading into larger areas and becoming slippery hazards
- Socks are ideal for surrounding spilled fluids and conform around machine bases to offer a snug fit with no leakage
- Booms have end loops with ties and are ideal for outdoor applications

Item #	Description	Size	Quantity	
SPK-MOPO1548	Oil Only Socks	3" x 4 ft.	15/case	\$82.95
SPK-MOPO10120	Oil Only Socks	3" x 10 ft.	10/case	\$145.55
SPK-B510	Oil Only Boom	5" x 10 ft.	4/case	\$155.25
SPK-GP1548	Gen. Purpose Socks	3" x 4 ft.	15/case	\$82.95
SPK-GP10120	Gen. Purpose Socks	3" x 10 ft.	10/case	\$135.85



Economy Spill Kit in Tote

- Contents: 10 pads, 1 sock (3" x 10 ft.), 1 pair gloves, 1 disposal bag
- 5 gallon capacity

Item #	Description	
SPK-CSKYB50	Oil Only	\$54.05
SPK-CSKYB5U	Universal	\$56.25

Economy Spill Kit in Zippered Bag

- Contents: 10 pads, 1 sock (3" x 10 ft.), 1 pair gloves, 1 disposal bag
- 5 gallon capacity

Item #	Description	
SPK-CSKZVO	Oil Only	\$38.85
SPK-CSKZVU	Universal	\$41.15

5 Gallon Spill Kit

- Contents: 10 pads, 2 socks (3" x 4 ft.), 1 pair gloves, 1 disposal bag, 1 pair goggles

Item #	Description	
SPK-SK5	Oil Only	\$98.45
SPK-GPSK5	Universal	\$98.65

30 Gallon Spill Kit

- Contents: 50 pads, 12 socks (3" x 4 ft.), 4 pillows (8" x 18"), 1 pair gloves, 1 disposal bag, 1 pair goggles

Item #	Description	
SPK-SK30	Oil Only	\$369.25
SPK-GPSK30	Universal	\$381.15

55 Gallon Spill Kit

- Contents: 100 pads, 2 booms (5" x 10 ft.), 5 pillows (8" x 18"), 1 pair gloves, 1 disposal bag, 1 pair goggles

Item #	Description	
SPK-SK55	Oil Only	\$565.15
SPK-GPSK55	Universal	\$579.75



SPK-HD2205 **\$17⁹⁵** SpeediKleen™ Premium All-Purpose Oil Absorbent

- Designed for the ultra high absorption and quick clean-up of water, grease, oil, paints, alcohols, solvents, coolants and fuels
- Small granules made of diatomaceous earth, delivers 50% more absorbency per pound than clay alternatives
- 20 lbs/bag

Metal Polishes/Cleaners

World-Famous Metal Polish

- This cleaning and conditioning product for all metal surfaces removes dirt and surface rust in a single treatment while leaving a protective coating
- Provides a brilliant high gloss finish

Item #	Description	
ATS-1000	75ml Tube	\$9.05
ATS-1100	750ml Can	\$66.75



ATS-1210 **\$10⁸⁵**

Metal Polish Liquid, 250ml

- This liquid cleaning and care product is for all metal surfaces
- Ensures intensive but gentle cleaning of weathered surfaces and stubborn tarnishing
- Gives dull surfaces a new brilliance
- Ideal for large surfaces

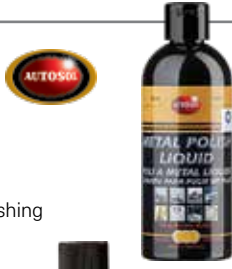

ATS-1290 **\$21⁰⁵**

Bluing Remover, 125ml

- Removes persistent burns and blue discoloration from stainless steel exhaust pipes and gives them their silver shine



Lubricants

AMT-70-05 **\$35¹⁵**

The Original Torsion Spray – Liquid Spanner, 400 ml

- Loosens highly seized bolts, nuts, junctions
- Extremely high capillary action
- Acid and grease-free
- No residues left after approx. 10 minutes

Metaflux



LPS-C02016 **\$11⁸⁵**

TKX® All-Purpose Lubricant

- 368 ml (312 g) Aerosol

C02016



LPS

LPS-C30216 **\$23⁵⁵**

LPS 2® Heavy Duty Lubricant/Penetrant

- 369 ml (312 g) Aerosol

C30216



LPS

Contact Cleaners



LPS-C03116 **\$35⁰⁵**

CFC Free Electronic Contact Cleaner

- 465 ml (312 g) Aerosol

LPS

Paint Pens

Markal

96960EA



96963EA



Paint-Riter®+ Oily Surface Liquid Paint Markers

- Superior marking performance on oily & greasy surfaces
- Dries quickly, fade-resistant

Item #	Colour		
MKL-96960EA	WHITE		\$5.15
MKL-96961EA	YELLOW		\$5.15
MKL-96962EA	RED		\$5.15
MKL-96963EA	BLACK		\$5.15

Markal

96820EA



96821EA



96825EA



Paint-Riter® Valve Action® Liquid Paint Markers

- Fast-drying liquid paint, long-lasting, wear- and weather-resistant
- Dura-Nib medium bullet tip resists wear

Item #	Colour		
MKL-96820EA	WHITE		\$4.75
MKL-96821EA	YELLOW		\$4.75
MKL-96822EA	RED		\$4.75
MKL-96823EA	BLACK		\$4.75
MKL-96825EA	BLUE		\$4.75



16504



Paint Pens

- Marks won't chip, peel, fade or rub off
- Marks on metal, plastic, glass, wood, etc.
- Works on porous or non-porous, rough or smooth, wet, oily or dry surfaces
- Withstands temperatures in excess of 600°F/300°C

Item #	Colour		
SHA-16501	WHITE		\$9.85
SHA-16502	BLACK		\$9.85
SHA-16503	BLUE		\$9.85
SHA-16504	RED		\$9.85
SHA-16505	YELLOW		\$9.85
SHA-16506	GREEN		\$9.85
SHA-16507	SILVER		\$9.85
SHA-16508	ORANGE		\$9.85

Milwaukee

48-22-3712



48-22-3722



INKZALL™ Jobsite Markers

- Best performance on tough jobsite surfaces

Item #	Description		
MLW-48-22-3104	4-Pack Black Fine Point		\$5.55
MLW-48-22-3106	4-Pack Colored Fine Point		\$6.95
MLW-48-22-3712	White Liquid Paint Marker, Medium Point		\$8.25
MLW-48-22-3722	Yellow Liquid Paint Marker, Medium Point		\$8.25

Batteries



DURACELL



DL2032BPK | PC2400 | PC1500 | PC1400 | PC1300 | PC1604

Duracell Procell Non-Rechargeable Batteries

Item #	Description	Qty	
DUR-DL2032BPK	Duracell "3V" Lithium Coin Cell Battery	1	\$4.75
DUR-PC1604	Procell "9V" Alkaline Battery	1	\$2.85
DUR-PC1500	Procell "AA" Alkaline Battery	Pack of 4	\$2.85
DUR-PC2400	Procell "AAA" Alkaline Battery	Pack of 4	\$2.85
DUR-PC1400	Procell "C" Alkaline Battery	1	\$1.68
DUR-PC1300	Procell "D" Alkaline Battery	1	\$1.95

Electrical Tapes

3MM-165BK4A **\$18⁵⁵**

Temflex™ General Use Black Vinyl Electrical Tape, 10 Rolls

- 3/4" x 60 ft. (19 mm X 18.3 m)
- Thickness: 6 mil (0.15 mm)
- Temperature range: 0° to 90°C
- Resists abrasion, moisture, alkalis, solvents and acids
- UL Listed, CSA and VDE Certified



3M

Threadlockers



Vibra-Tite® Threadlockers

Item #	NDI-12210	NDI-12150	NDI-14050
Description	Vibra-Tite® 122	Vibra-Tite® 121	Vibra-Tite® 140
Size	10ml	50ml	50ml
Colour	BLUE Threadlocker	BLUE Threadlocker	RED Threadlocker
Strength	<ul style="list-style-type: none"> • Medium • Oil Tolerant • Removable 	<ul style="list-style-type: none"> • Medium • Removable 	<ul style="list-style-type: none"> • High • Removable
Fastener Diameter	1/4" to 3/4" (6mm-20mm)	1/4" to 3/4" (6mm-20mm)	Up to 1" (25mm)
Break Away Torque	195 in-lbs	100 in-lbs	250 in-lbs
Fixture / Cure Times	30 min / 24 hrs	20 min / 24 hrs	30 min / 24 hrs
Temp. Range	-65°F to 300°F (-51°C to 150°C)	-65°F to 300°F (-51°C to 150°C)	-65°F to 300°F (-51°C to 150°C)
Competes with	Loctite® 243™	Loctite® 242™	Loctite® 271™
	\$10.05	\$26.45	\$26.45

Glue Guns

DEW-DWHTGR50 **\$31⁹⁵**

Professional Rapid Heat Ceramic Glue Gun, 120V 50W

- Ready to glue 50% faster with efficient ceramic heating element
- High-output design applies over 50 glue sticks per hour
- Sturdy fold-out stand and rubber base help prevent mishaps



DEW-DWHT75097 **\$8¹⁵**

6-Pc Super Strength Hot Melt Glue Sticks

- 10" x 0.45" diameter



Adhesives & Glues



RFX-6121805EF **\$38⁴⁵**

RapidFix UV Liquid Plastic Adhesive with UV Flashlight

- (1) 10ml adhesive bottle
- Allows as much time as needed to position pieces properly
- Shine the UV light on the adhesive for 10 - 20 seconds to cure
- Adhesive dries crystal clear
- The high strength bond can be sanded, filed, drilled and painted

RAPIDFIX



RFX-6121830EF **\$26³⁵**

UV Liquid Plastic Adhesive Refill Twin Pack, 20ml

RAPIDFIX



RFX-7121100 **\$46⁴⁵**

Professional Dual Adhesive and Welding System, 25ml

- Produces high strength bonds in seconds
- Fill cracks, holes and gaps
- Can be drilled, filed, sanded or ground
- Dries neutral and can be painted or stained
- Kit contains (1) 25 ml adhesive bottle and (1) 25 ml welding powder bottle

RAPIDFIX

Fiberglass-Reinforced Repair Patch

• Self-adhesive and long lasting repair patch for a wide variety of repairs. Will work on almost any hard surface including metals, fiberglass, plastics and many more.

- Can be sanded, grinded, drilled, tapped and painted. It is waterproof, weather-proof, rot, rust, fire and impact-proof. Chemical and temperature resistant from -40°C to 200°C.
- The patch comes out of the package pliable, but after just 10 minutes of sunlight or UV light exposure becomes as hard as steel.
- The patch will not shrink or expand during application or when cured.

Item #	Size	
POR-10787010	3" x 6"	\$46.55
POR-10787020	6" x 9"	\$83.45

portasol



Assortment Sets



Item #	FUSES	
TIT-45230	88-Pc Master Blade Fuse Assortment, 3A - 100A	\$30.05
ATD-364	120-Pc ATC Car Fuse Assortment, 5A - 30A	\$13.35
TIT-45231	71-Pc Micro Blade Fuse Assortment, 5A - 30A	\$38.35
ATD-382	100-Pc Mini Blade Fuse Assortment, 5A - 30A	\$9.55
ATD-386	50-Pc Maxi Blade Fuse Assortment, 20A - 60A	\$68.05
TIT-45232	24-Pc Maxi Blade Fuse Assortment, 20A - 100A	\$35.95
ATD-392	100-Pc Low-Profile ATM Fuse Assortment, 7.5A - 30A	\$28.15



Item #	TERMINALS	
ATD-355	360-Pc Terminal Assortment	\$35.95
ATD-383	75-Pc Heat Shrinkable Terminal Assortment	\$93.35



Thermaflox Crimp™ Butt Splices

- Heat shrinkable and adhesive-lined

BUTT SPLICES

Item #	Gauge	Qty	
TFX-16104	22-18	100	\$87.15
TFX-16105	16-14	100	\$87.15
TFX-16106	12-10	100	\$88.35



Item #	HEAT SHRINK TUBES	
ATD-393	235-Pc 6" Heat Shrink Tube Assortment, 3/32" - 3/4"	\$25.55
ATD-394	115-Pc 3" Long Dual Wall Adhesive Lined Heat Shrink Tube Assortment, 1/8" - 1"	\$23.95
TIT-45238	171-Pc Heat Shrink Tube Assortment, 3/32" - 3/4"	\$19.95
TIT-45239	106-Pc Dual-Wall Heat Shrink Tube Assortment	\$45.95
TFX-10004	61-Pc Heat Shrink Tube Assortment, 6" Long	\$58.05

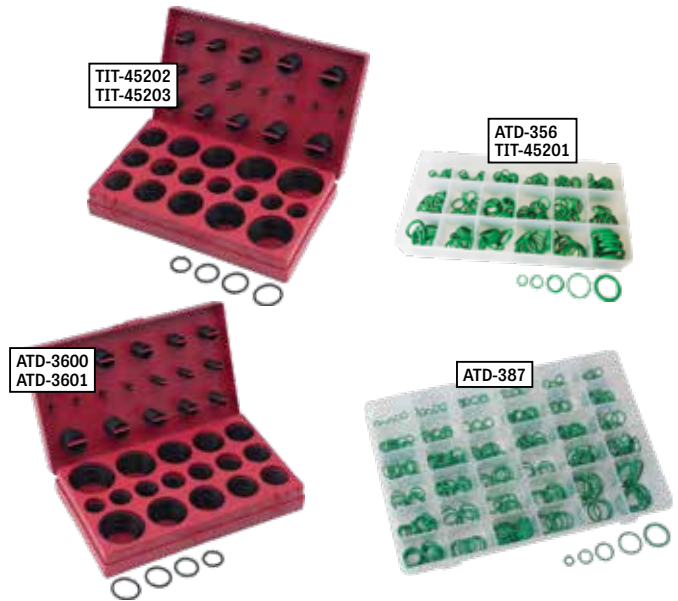

Item #	O-RINGS	
ATD-3600	407-Pc SAE Universal O-Ring Assort., I.D. 1/8"-2-1/4"	\$30.85
ATD-3601	419-Pc Metric Univer. O-Ring Assort., I.D. 3mm-50mm	\$20.25
TIT-45202	407-Pc SAE O-Ring Assortment	\$26.45
TIT-45203	419-Pc Metric O-Ring Assortment	\$26.45
ATD-356	270-Pc HNBR O-Ring Assortment for R12 and R134A	\$53.65
TIT-45201	270-Pc HNBR O-Ring Assortment for R134A	\$15.55
ATD-387	350-Pc HNBR O-Ring Assortment for R12 and R134A	\$104.35

Assortment Sets



ATD-349



ATD-381



TIT-45251



TIT-45235

Item #	SCREWS, NUTS & BOLTS	
ATD-349	200-Pc Hex Washer Head Self-Drilling Screw Assortment - #8, #10	\$23.25
ATD-381	200-Pc SAE Hex Head Socket Screw Assortment	\$39.55
TIT-45251	160-Pc Metric Hex Head Socket Screw Assortment	\$16.95
TIT-45235	160-Pc SAE Hex Head Socket Screw Assortment	\$27.65



ATD-351



TIT-45208

Item #	E-CLIPS	
ATD-351	300-Pc E-Clip Assortment, 1/16" - 7/8"	\$13.05
TIT-45208	300-Pc E-Clip Assortment, 1/16" - 7/8"	\$14.95



ATD-354



TIT-45212

Item #	SNAP RINGS	
ATD-354	300-Pc External Snap Ring Assortment, 1/4" - 1-1/4"	\$16.95
TIT-45212	300-Pc Snap Ring Assortment Internal: 3/16" - 7/8" • External: 1/8" - 1-1/4"	\$14.25

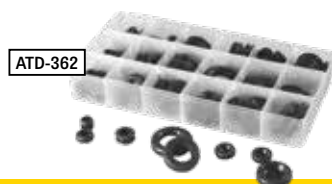

ATD-362

Item #	RUBBER GROMMETS	
ATD-362	125-Pc Rubber Grommet Assortment	\$25.85



ATD-363
TIT-45206



ATD-350
TIT-45205



ATD-353
TIT-45210



ATD-372



ATD-373

Item #	PINS (Cotter Pins, Hitch Pins, Roll Pins)	
ATD-350	555-Pc Cotter Pin Assortment, 1/16" - 5/32"	\$11.65
TIT-45205	555-Pc Cotter Pin Assortment, 1/16" - 5/32"	\$17.45
ATD-363	144-Pc Large Cotter Pin Assortment, 1/8" - 5/16"	\$12.05
TIT-45206	144-Pc Large Cotter Pin Assortment, 1/8" - 5/16"	\$23.65
ATD-353	150-Pc Hitch Pin (Hair Pin) Assortment, 3/32" - 5/32"	\$25.05
TIT-45210	150-Pc Hitch Pin (Hair Pin) Assortment, 3/32" - 5/32"	\$13.75
ATD-372	315-Pc Roll-Pin Assortment, 1/16" - 3/8"	\$62.35
ATD-373	245-Pc Roll-Pin Assortment, 1/16" - 1/4"	\$35.25

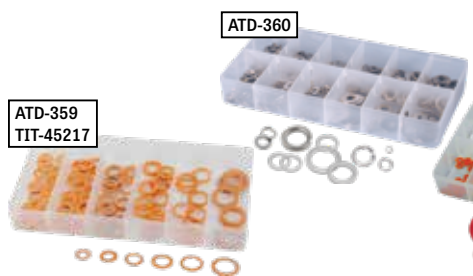

ATD-360

ATD-359
TIT-45217

ATD-371

Item #	WASHERS	
ATD-359	110-Pc Copper Washer Assortment, 1/4" - 5/8"	\$57.65
TIT-45217	110-Pc Copper Washer Assortment, 1/4" - 5/8"	\$26.65
ATD-360	350-Pc Stainless Lock Washer and Flat Washer Assortment, #6, #8, #10, 1/4", 5/16", 3/8"	\$28.15
ATD-371	200-Pc Fiber & Nylon Washer Assortment, 1/8" - 1/2"	\$42.65



ATD-352



TIT-45200

Item #	SPRINGS	
ATD-352	200-Pc Extension & Compression Spring Assortment	\$20.75
TIT-45200	200-Pc Extension & Compression Spring Assortment	\$13.35

Assortment Sets



Item #	RIVETS	
ATD-337	150-Pc Rivet Nut Assortment, M5 x 13mm, M6 x 15mm, M8 x 18mm, 10-24, 1.4"-20, 5/16"-18	\$14.25
ATD-346	500-Pc Aluminum Blind Rivet Assortment, 1/8" - 3/16"	\$25.55
TIT-45228	500-Pc Aluminum Blind Rivet Assortment, 1/8" - 3/16"	\$19.95



Item #	GREASE & OIL	
ATD-357	110-Pc SAE Hydraulic Grease Zerk Fitting Assortment	\$29.55
ATD-374	110-Pc Metric Grease Zerk Fitting Assortment	\$29.25
TIT-45215	70-Pc SAE Grease Fitting Assortment	\$20.05
TIT-45274	110-Pc Metric Grease Fitting Assortment	\$27.15
ATD-389	120-Pc Oil Drain Plug Gasket Assortment	\$77.05



Item #	BRAKE	
ATD-391	90-Pc Brake Bleeder Screw Assortment	\$92.35
ATD-39361	95-Pc Brake Line Fittings Assortment	\$277.85

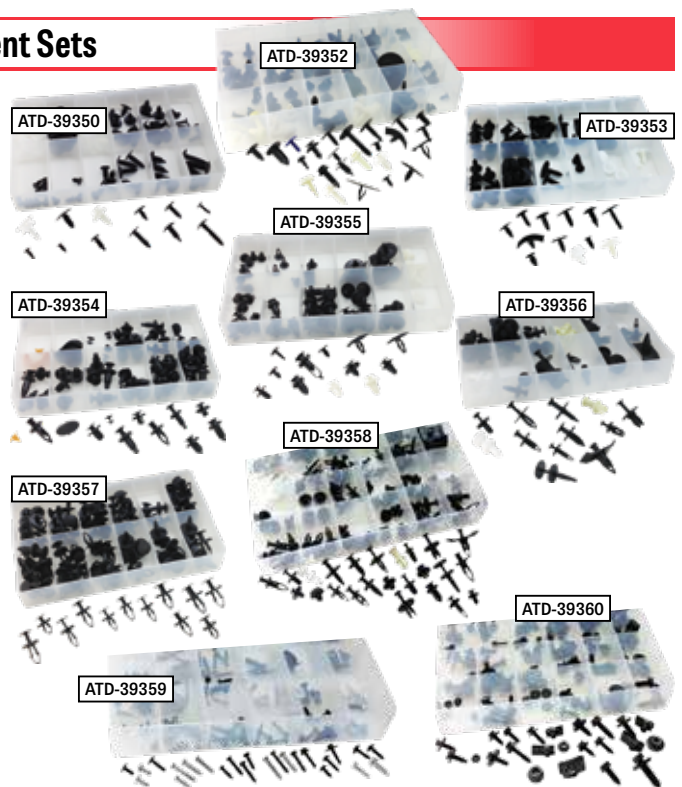

Item #	RETAINERS & SCREWS (BODY)	
ATD-39350	90-Pc GM Retainer Assortment	\$74.95
ATD-39352	120-Pc FORD Retainer Master Assortment	\$130.65
ATD-39353	80-Pc CHRYSLER Retainer Assortment	\$85.65
ATD-39354	80-Pc HONDA Retainer Assortment	\$137.85
ATD-39355	80-Pc TOYOTA Retainer Assortment	\$143.35
ATD-39356	60-Pc Push-Pin Type Retainer Assortment	\$88.05
ATD-39357	105-Pc ERGO TUFLOK® Retainer Assortment	\$159.45
ATD-39358	120-Pc Push-Type Retainer Master Assortment	\$169.45
ATD-39359	185-Pc Universal Trim Screw Master Assortment	\$100.75
ATD-39360	120-Pc Master Hex Nut, U-Nut and Body Bolt Assortment	\$161.25

Cable Ties



TEC-762864 **\$77²⁵**
Heavy-Duty Cable Tie Tool
 • Automatic cut-off
 • Adjustable tensioning
 • Use with 18-50 lbs capacity cable ties



Black Cable Ties
 • Heat stable to 250°F and UV resistant

Item #	Length	Tensile	Qty	
MAY-MB5-40HS-C	5"	40 lbs	100	\$4.25
MAY-MB5-40HS-M	5"	40 lbs	1000	\$33.55
MAY-MB7-50HS-C	7"	50 lbs	100	\$7.95
MAY-MB7-50HS-M	7"	50 lbs	1000	\$67.65
MAY-MB8-40HS-C	8"	40 lbs	100	\$5.85
MAY-MB8-40HS-M	8"	40 lbs	1000	\$60.85
MAY-MB11-50HS-C	11"	50 lbs	100	\$11.45
MAY-MB11-50HS-D	11"	50 lbs	500	\$52.75
MAY-MB14-50HS-C	14"	50 lbs	100	\$13.75
MAY-MB14-50HS-D	14"	50 lbs	500	\$54.75
MAY-MB14-120HS-C	14"	120 lbs	100	\$25.15



Black Cable Ties
 • UV stabilized

Item #	Length	Tensile	Qty	
ATD-20418	18"	120 lbs	25	\$18.05
ATD-20425	25"	175 lbs	25	\$25.15
ATD-20436	36"	175 lbs	25	\$25.95

CREEPERS & SEATS

Creepers



LIS-21350 **\$41²⁵**

Jeepers Keeper™ Creeper Hanger

- 24" rail with adjustable ABS plastic hooks can be attached to most toolboxes, benches or walls



LIS-95002 **\$91⁶⁵**

Padded Vinyl Fold-Up Creeper

- Adds comfort and protection on the job
- 18" x 48"



ATD-81015 **\$101³⁵**

Foldable Creeper Pad

- Made from heavy duty EVA foam that is water, chemical and impact resistant
- 47-5/8" x 16-1/2" x 1-1/8" (unfolded)



300 Lbs Capacity Plastic Creepers

- (6) Casters
- Dimensions: 38" L x 17-1/2" W



Item #	Description	Colour	Casters	Height	Floor Clear.	
LIS-92032	XL Wheels	Red	4"	8-5/8"	3-3/4"	\$277.95
LIS-92102	Low Profile	Red	2"	4"	7/8"	\$199.55
LIS-93202	Low Profile	Orange	2"	4"	7/8"	\$210.95
LIS-97102	Low Profile	Black	2"	4"	7/8"	\$199.55
LIS-99102	Low Profile	Green	2"	4"	7/8"	\$210.95



48" Plastic Creeper with Dual Tool Trays

- Weight capacity: 440 lbs
- 6 oil resistant 3" swivel casters
- Padded head rest



Heavy Duty Blow Molded Creepers

- Unrestricted arm movement
- Rubber oil/fuel resistant wheels



ATD-81051 **\$99⁹⁵**

300 Lbs Capacity

- 39.75" L x 19" W x 4.25" H
- (6) 3" swivel casters



ATD-81060 **\$122⁵⁵**

400 Lbs Capacity

- 45" L x 22.5" W x 6" H
- (6) 4" swivel casters



GWR-86995 **\$272⁶⁵**

41" Low Profile Blow Molded Creeper

- Weight capacity: 300 lbs
- (6) 3" casters with ball bearings
- Steel plates next to headrest to hold magnetic-backed lights and tools in place
- Magnetic parts trays for convenient storage



SUN-8504 **\$160⁵⁵**

36" Creeper

- Weight capacity: 250 lbs
- Cushioned red vinyl cover
- (4) Casters: 2.5"
- Ground clearance: 1.75"
- Dimensions: 36" x 17" x 3.5"



SUN-8505 **\$170¹⁵**

40" Creeper with Adjustable Head Rest

- Weight capacity: 250 lbs
- Cushioned red vinyl cover
- (6) Casters: 2.5"
- Ground clearance: 1.75"
- Dimensions: 40" x 17" x 4"



SUN-8515 **\$345⁵⁵**

Deluxe Comfort Extreme Creeper

- Weight capacity: 300 lbs
- Cushioned red vinyl cover
- 5-Position head rest
- (4) Casters: 3.5" • Ground clearance: 1.75"
- Dimensions: 45.5" x 19" x 5"



Creepers

TRAXION
engineered products

TRX-1-200 **\$179⁹⁵**

King Crawler "All-Terrain" Creeper

- Weight capacity: 400 lbs
- Thick, high-gloss padded deck is very durable and easy to clean
- X-frame design minimizes frame interference and maximizes mobility
- Casters: 5"
- Dimensions: 43" x 26.25" x 6.875"



TRAXION
engineered products

TRX-1-100 **\$199⁹⁵**

ProGear Wide Body Creeper

- Weight capacity: 400 lbs
- Wide body deck with lumbar support
- Casters: 5"
- Ground clearance: 2"
- Dimensions: 40" x 21.25" x 6.5"



ATD

ATD-81046 **\$230⁶⁵**

40" Low Profile Creeper

- Weight capacity: 400 lbs
- 2" height to the top of the bed
- 1/2" ground clearance
- (6) 3" casters
- 40" L x 26-3/4" W



ATD-81042 **\$151⁴⁵**

40" Professional Creeper

- Weight capacity: 300 lbs
- Adjustable head rest
- (6) 3" industrial strength casters
- 40" L x 16-3/4" W



ATD

ATD-81045 **\$226³⁵**

40" Convertible Creeper/Shop Seat

- Weight capacity: 300 lbs
- Heavy duty steel frame
- (6) 3" casters with full ball bearings
- 40" L x 19" W x 6-1/2" H



ATD

ATD-81049 **\$313³⁵**

Heavy-Duty 3-in-1 Low Profile Z-Creeper

- Weight capacity: 450 lbs
- Converts from creeper to Z-Creeper seat to L-Seat
- (6) 3" casters
- 40" L x 26" W x 4-3/4" H



TRAXION
engineered products

TRX-3-100 **\$430⁶⁵**

Topside Creeper®

- Weight capacity: 400 lbs
- Ergonomic design
- Locking casters for security and leverage
- Padded deck is comfortable and easy to clean
- The Topside Creeper folds up for easy and compact storage
- Height adjustment: 48" to 64"
- Dimensions: 55" x 24" x 64"



TRAXION
engineered products

TRX-3-700 **\$599⁹⁵**

ProGear Topside Creeper

- Weight capacity: 400 lbs
- I-Base design for more flexible positioning around vehicle
- Fully padded frame with cleanable and replaceable padded upholstery cover
- The ProGear Topside Creeper® folds up for easy and compact storage
- Height adjustment: 52" to 72" in increments of 6"
- Dimensions: 52" x 36" x 72"

ProGear



ATD-8116F **\$550²⁵**

Foldable Topside Creeper

- Weight capacity: 400 lbs
- Adjustable from 48" to 64"
- Slip-resistant steps
- 3-position locking angle adjustment
- 3" Heavy duty locking casters
- Folds compact for easy storage



Seats



- ATD-81010 **\$261⁵⁵**
Hydraulic Creeper Seat
 • Weight capacity: 300 lbs
 • Height adjustment: 16" to 21"
 • (5) 2-1/2" wheels (ATD-81001)
 • Heavy vinyl padded seat



- GWR-86994 **\$229¹⁵**
Adjustable Height Swivel Mechanics Seat
 • Weight capacity: 225 lbs
 • Height adjustment: 18" to 22"
 • 3-1/2" casters
 • 5 removable magnetic parts trays in the base



- SUN-8509 **\$136⁰⁵**
Pneumatic Shop Seat
 • Weight capacity: 300 lbs
 • Height adjustment: 15.5" to 20.5"



- ATD-81012 **\$372¹⁵**
Hydraulic Tractor Style Creeper Seat
 • Weight capacity: 300 lbs
 • Height adjustment: 16" to 21"
 • (5) 2-1/2" wheels
 • Seat dimensions: 18" W x 9.5" D



- ATD-81047 **\$267¹⁵**
Heavy-Duty Toolbox Creeper Seat
 • Weight capacity: 450 lbs
 • (4) 3" swivel casters
 • 3 drawers with roller bearing slides
 • Front and back tool trays
 • 18-1/4" H x 14-3/4" W x 18-3/4" D



- SUN-8514 **\$247²⁵**
Pneumatic Tractor Seat
 • Weight capacity: 300 lbs
 • Seat height adjustment: 18" to 22"



- ATD-81009 **\$91⁷⁵**
Mechanic's Padded Creeper Seat
 • Weight capacity: 250 lbs
 • 2.5" casters (ATD-81008)
 • 14" H x 17" L



- TRX-2-230 **\$213³⁵**
MonsterGear Seat
 • Weight capacity: 400 lbs
 • Large padded tractor seat
 • Spinning gear tray
 • Casters: 5"
 • Seat height adjustment: 13-1/2" to 17-1/2"



- SUN-8507 **\$99³⁵**
Creeper Seat
 • Weight capacity: 200 lbs
 • Vinyl seat with 2" high compression foam
 • 2.5" casters
 • 14" H x 17" L



- TRX-2-700R **\$239⁹⁵**
ProGear Race Seat
 • Weight capacity: 400 lbs
 • Comfortable, padded seat
 • Giant spinning gear tray
 • Casters: 5"
 • Seat height adjustment: 13-1/2" to 17-1/2"



Garage Exhaust Solutions



ACT Hoses (No Wire)

- Designed for use with **larger gas vehicles and diesel trucks**
- The hose, which does not contain a wire helix, returns back to its original shape if "crushed" by any vehicles or other machinery
- Hoses will withstand exhaust temperatures up to 600°F when used with a proper adapter and a fan assisted system



Item #	Hose Size	
CRU-ACT500	5" I.D. x 11 ft. long	\$389.55
CRU-ACT600	6" I.D. x 11 ft. long	\$492.05

FlareLok® Hoses

- Designed for use with **smaller gas vehicles, SUV's and pickup trucks**
- The FlareLok® system with male and female ends, allows multiple lengths to be connected without the need for a splice connector
- Hoses will withstand exhaust temperatures up to 600°F when used with a proper adapter and a fan assisted system

Item #	Hose Size	
CRU-FLT250	2.5" I.D. x 11 ft. long	\$145.65
CRU-FLT300	3" I.D. x 11 ft. long	\$176.05
CRU-FLT350	3.5" I.D. x 11 ft. long	\$249.85
CRU-FLT400	4" I.D. x 11 ft. long	\$275.25



Dynamometer Hoses & Adapters

- Designed for use with dynamometers and in **high performance applications**
- It will withstand exhaust temperatures of up to 700°F when used with a fan assisted system, and will survive where other hoses cannot

Item #	Size	Tailpipe Diameter	
CRU-ACT400DYNO	4" I.D. x 11 ft. long		\$355.45
CRU-F475DYNO	3" x 6" oval	Twin up to 2"	\$93.05
CRU-F350DYNO	3.5" diameter	Up to 3"	\$81.75

Y-Assembly Kits

- Includes two 4-ft. hoses, one "Y" connector and two hose adapters

Item #	Hose Size	
CRU-YA250	2.5"	\$216.65
CRU-YA300	3"	\$262.15
CRU-YA400	4"	\$430.65



Y-Connectors

Item #	Hose Size	Material	
CRU-RY25	2.5" hose	Rubber	\$46.65
CRU-RY30	3" hose	Rubber	\$49.05
CRU-AY40	4" hose	Aluminum	\$119.75



Door Ports

Item #	Hose Size	Material	
CRU-DF25	2.5" hose	Rubber	\$45.85
CRU-ADF30	3" hose	Aluminum	\$54.95
CRU-ADF40	4" hose	Aluminum	\$73.75



Hose Adapters & Accessories

Item #	Style	Max. Tailpipe O.D.	Hose I.D.	
CRU-RA250	Bell	5"	2.5", 3.5"	\$51.55
CRU-RA300	Bell	5"	2", 3"	\$51.55
CRU-F475	Oval, for Twin Tailpipe	2.5" x 5.5"	3", 4"	\$56.95
CRU-F575	Oval, for Twin Tailpipe	3" x 8"	3", 4"	\$73.15
CRU-F675	Oval, for Twin Tailpipe	2.5" x 10.5"	3", 4"	\$144.75
CRU-DSR600	Diesel Stack	5.5"	4", 5"	\$114.35
CRU-DSR600-6	Diesel Stack	5.5"	6"	\$134.35

Exhaust Service Tools



ATD-5721 **\$81¹⁵**

Exhaust Pipe Cutter Pliers

- Cut pipes 3/4" to 3-1/4" (19 to 83mm) in diameter



\$41²⁵

LIS-38350

Exhaust Removal Pliers

- Separates exhaust hanger brackets from rubber supports

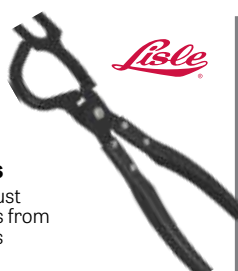

GWR-2031DD **\$79⁴⁵**

Exhaust and Tailpipe Cutter

- Cut pipes 3/4" to 3" (19 to 76mm) in diameter

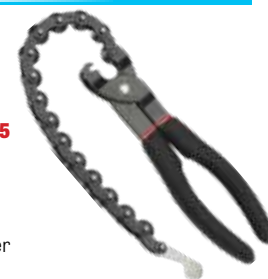

Tailpipe Stretchers



LIS-17350 **\$441⁷⁵**

Exhaust/Tailpipe Stretcher Kit

- Use with an impact wrench to quickly stretch pipes
- Expands all types of exhaust pipe, including stainless steel, from 1-5/8" to 4-1/4" in size



LIS-17060 **\$88⁸⁵**

5" Adapter for Tailpipe Stretcher

- This tool must be used with the Lisle#17350 Tailpipe Stretcher Kit

LIS-34400 **\$212⁷⁵**

Exhaust/Tailpipe Stretcher

- Use with an impact wrench to quickly stretch pipes
- Two collet sets fit pipes from 1-5/8" to 2-7/16"



TBQ-34700 **\$125⁵⁵**

7-Pc Exhaust Pipe Stretcher Kit

- Use with an impact wrench to quickly stretch all pipes, including stainless steel
- Stretch pipes from 1-5/8" to 4-1/4"



AST-78835 **\$249¹⁵**

Exhaust Pipe Stretcher Kit

- Impact driven heavy-duty expander
- Expands pipes from 1-5/8" to 4-1/4"



ATD-5723 **\$69⁴⁵**

3-Pc Tailpipe Expander Set

- For use on all types of tailpipes, mufflers and exhaust systems
- Works with all 1-1/8" to 3-1/2" inner diameter thin-wall pipes
- Not for use with an impact wrench



Made in Canada

#411000106

Portable Air/Hydraulic Tailpipe Expanders

- Lets you replace only worn-out sections of exhaust pipe
- Includes: hand expander gun, cart, pump, hose and segments



411000101S



BBP-411000106

Truck Exhaust Pipe Expander

- Comes with 3 segments: 3-1/2", 4", 5"

BBP-411000101S

Car Exhaust Pipe Expander

- Comes with 6 segments: 1-1/2", 1-3/4", 2", 2-1/4", 2-1/2", 3"

Manifold Service Tools



72400

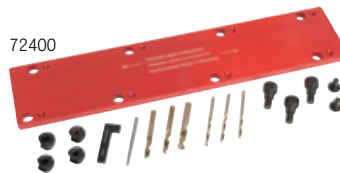

71500

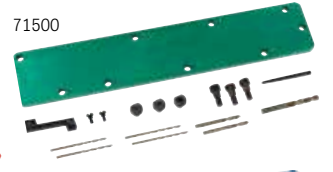

72610



68500

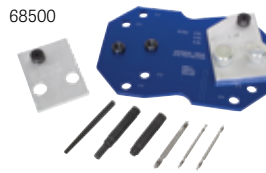

71600



71400

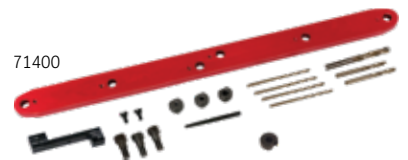

Manifold Drill Templates

- Designed to remove broken exhaust manifold bolts/studs without damaging the cylinder head

Item #	Make	Application	
LIS-71500	Dodge	5.7L Hemi	\$261.25
LIS-72400	Duramax	6.6L Diesel	\$255.05
LIS-72610	Ford	3.5L Ecoboost	\$267.45
LIS-68500	Ford	4.6L, 5.4L and 6.8L V10 2-valve and 3-valve Ford Triton	\$186.65
LIS-71600	Ford	4.6L, 5.4L and 6.8L	\$335.95
LIS-71400	GM	1999+ GM LS III 4.8L, 5.3L & 6.0L	\$223.95

Body Repair Tools & Equipment

Porto-Power
BLACKHAWK AUTOMOTIVE

BHK-B65114 **\$568⁷⁵**

4-Ton Body Repair Equipment Kit

- Pump: 8,000 psi
- Ram closed: 11"
- Ram extended: 15.75"
- Ram effective area: 0.99 in²



904005B

NORCO

910006B



Collision/Maintenance Repair Kits

- Cast adapters
- 10,000 psi pump with gauge

Item #	Capacity	
NRC-904005B	4-Ton	\$469.75
NRC-910006B	10-Ton	\$694.45

Porto-Power
BLACKHAWK AUTOMOTIVE

BHK-B65115 **\$803²⁵**

10-Ton Body Repair Equipment Kit

- Pump: 10,000 psi
- Ram closed: 13.63"
- Ram extended: 19.75"
- Ram effective area: 2.41 in²



NORCO



NRC-920020A

20-Ton Collision/Maintenance Repair Kit

- A deluxe kit for repairing heavy road machinery, trucks, farm equipment and also used for some heavy construction applications
- Forged adapters • Two-speed pump with gauge

ATD

ATD-5800A **\$582⁸⁵**

4-Ton Hydraulic Body Repair Kit

- Pump: 8,000 psi
- Ram closed: 10.5"
- Ram extended: 15.2"
- Ram effective area: 1.1 in²



DTF-DF-505/220V



The Maxi - Steel Dent Pulling System

- This 220 volt single phase station provides the power to shrink stretched metal and pull all types of dents and creases without putting holes in the panel
- **Just weld on a pull rod, pull the dent out and twist to release the weld**

The Maxi unit comes with:

- Light pulling and slide hammer rods
- Leverage puller • Electrodes
- Wiggle wire weld tip
- 2 Bear Claws (9 and 4 finger)
- Sample stud weld pins and pull keys
- 1 pound of wiggle wire



DENT FIX EQUIPMENT

ATD-5810A **\$762⁰⁵**

10-Ton Hydraulic Body Repair Kit

- Pump: 10,000 psi
- Ram closed: 12.7"
- Ram extended: 17.8"
- Ram effective area: 2.46 in²



DTF-DF-DM555UDX **\$614¹⁵**

Ultra Ding Massager - Glue Puller Kit for Paintless Dent Repair

- Excellent method for removing dings and small dents from OEM paint when access to the back panel is not possible

The kit includes:

- Squeeze puller and T-puller
- Knock down tool with pointed and rounded heads
- 6 knockdown & shaping tools
- Slide Hammer • 120V Glue gun
- Plastic scraper stick • 12 Glue sticks
- 24 Different pulling nibs



ATD-5801 **\$915⁷⁵**

10-Ton Mini Hydraulic Ram Kit

- Perfect for lifting, pulling, pushing, alignment, etc.
- For use with ATD body repair kits or most other manufacturers
- Ram stroke: 1.5"
- Min./Max. cylinder height: 3.5"/5"
- Cylinder effective area: 2.35 in²



H&S AUTOSHOT

HAS-GPR-7571 **\$999⁸⁵**

GPR-Pro Glue Pulling System for Dent Repair

Body Repair Tools & Equipment

FMT-153GB **\$85²⁵**

Curved Cross Chisel

- Round face: 1-9/16" diameter
- Chisel: 3" long



Body Picks

Item #	Description	Price
FMT-1110	12" Curved Pick	\$36.15
FMT-1111	18" Curved Pick	\$36.75
FMT-1109	20" Curved Pick with 1" Chisel End	\$105.85
FMT-1106	26.5" Curved Pick	\$108.35
FMT-1107	31" Curved Pick	\$114.25

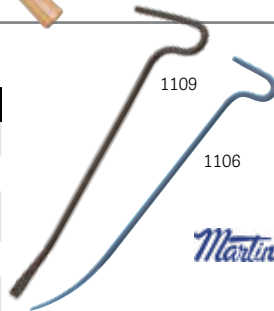

ATD-4030 **\$139⁴⁵**

7-Pc Heavy Duty Body & Fender Hammer Set with Fiberglass Handles

- Hammers: Bumping, pick and chisel end
- Dollies: Heel, shrinking, double-end, and curve

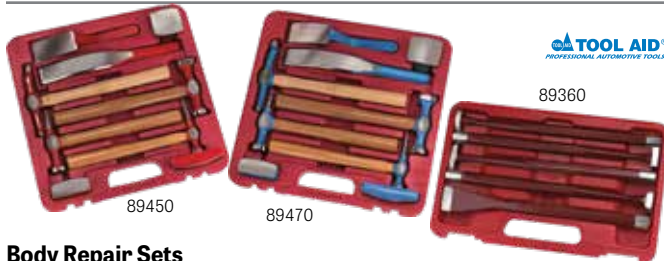

Body Repair Sets

Item #	Retracted	Price
SGT-89450	9-Piece ALUMINUM Body Repair Kit	\$362.55
SGT-89470	9-Piece STEEL Body Repair Kit	\$362.55
SGT-89360	5-Piece 12" Long Body Forming Punch Set	\$268.95

DTF-AH714 **\$239⁷⁵**

3-Pc Aluminum Body Hammer Set

- Pick and finishing hammer (40mm round face)
- Curved pein and finishing hammer (40mm round face)
- Standard bumping hammer (40.5mm round face, 38mm square face)



LOC-790 **\$62⁶⁵**

Shape Tip™ Tool

- Designed to fit securely on most pry bars
- Use to roll and massage out dents, high spots, creases and crowns around dents
- Great for applying tape seam sealer
- Repair bumpers, glue upholstery and patch tires



Polyvance

URT-6146 **\$410⁴⁵**

Bumper Pliers Kit

- Repairs torn rectangular slot tabs and recessed bolt holes in automotive bumpers
- Includes 6 different slot tab dies, one recessed hole die, and four sets of pliers to repair virtually any slot

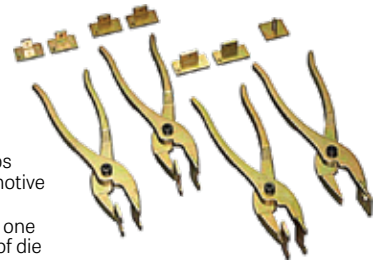

Polyvance



URT-6148 **\$182⁰⁵**

Bumper Dent Removal Rollers

- Wide and flat roller: for use on large areas
- Ball-shaped roller: for use on round radiuses
- Sharp edge roller: for use on sharp body lines



ATD-5160 **\$246⁸⁵**

Muscle Max 10 Lbs Heavy-Duty Dent Puller Set

- (1) 10 lbs hammer
- Dent pulling attachments



TOOL AID

SGT-81100 **\$464⁸⁵**

The Slugger Dent Puller & Slide Hammer

- 10 lb. slide hammer
- Includes body pulling and pushing attachments



TOOL AID

SGT-81500 **\$95³⁵**

Junior Slugger Dent Puller & Slide Hammer

- 3 lb. slide hammer
- Special wide body hook is used to pull curls and creases in quarter, rocker, back and door panels



HAS-DTK-7700 **\$355⁰⁵**

Uni-Vac™ Paintless Dent Repair Suction Pulling Tool

- Works on steel or aluminum panels, as well as bumpers
- Includes 3 different sized vacuum cups



Telescopic Measuring Tram Gauge

Item #	Description	Price
DTF-DF-3TC3A	3m - 2'6" to 9'2"	\$496.65
DTF-DF-3TC5A	5m - 3'6" to 15'4"	\$650.45



Plastic Welders & Accessories

URT-6485 **\$182⁰⁵** **Polyvance**

Aluminum Tape

- Holds broken plastic parts together while you do your plastic welding
- 2" x 180 ft. x 4 mil thick



URT-5700HT **\$463³⁵** **Polyvance**

Mini-Weld Model 7 – 200 Watt Plastic Welder

- Complete kit for making quality repairs to virtually any type of plastic including TEO, TPO, and Polypropylene
- Temperature selection control box
- Includes 8 types of plastic welding rod for repairing virtually any thermoplastic



Plastic Welding Rods

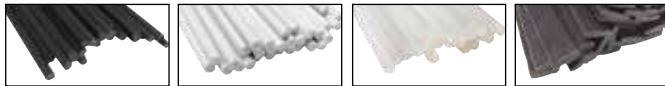

Item #	Material	Profile	Colour	Qty	
URT-R02-01-03-BK	Polypropylene	● 1/8"	Black	30 ft.	\$22.05
URT-R03-01-03-WH	ABS	● 1/8"	White	30 ft.	\$22.05
URT-R04-01-03-NT	Polyethylene	● 1/8"	Natural	30 ft.	\$22.05
URT-R10-04-03-BK	Fiberflex	3/8" x 1/16"	Black	30 ft.	\$55.85

MOTOR GUARD

MOT-MS-2500 **\$361³⁵**

Magna-Stitcher™ – Plastic Repair System

- Three power levels for rapid and precise staking of all thermoplastic materials

Kit contains:

- (1) **Ironing Tip** for smoothing rough areas (MS2045)
- (100) **S Shaped Stakes** for flat surface repair (MS2014)
- (100) **M Shaped Stakes** for tabs and narrow sections (MS2015)
- (100) **V Shaped Stakes** for inside corner repair (MS2016)
- (100) **W Shaped Stakes** for outside corner repair (MS2017)



Replacement Magna-Stakes™

Item #	Shape	Quantity	
MOT-MS2004	S-shaped	50/package	\$37.95
MOT-MS2005	M-shaped	50/package	\$37.95
MOT-MS2006	V-shaped	50/package	\$37.95
MOT-MS2007	W-shaped	50/package	\$37.95
MOT-MS2040	S-M-V-W	100 per shape	\$224.45

URT-6204 **\$398⁹⁵**

Hot Spot Cordless Rechargeable Plastic Stapler

- Makes plastic repairs stronger
- Holds broken plastics together securely and simplifies aligning for weld repairs

Includes:

- (100 each) 0.6mm & 0.8mm flat staples
- (100 each) 0.6mm & 0.8mm wave staples
- (100) inside corner staples



Polyvance
ADVANCING PLASTIC REPAIR

Nitro-Fuzer® Nitrogen Welding Systems for Plastic Repair

- Make repairs on virtually any type of plastic
- Make repairs that are stronger than any two-part epoxy or hot air weld
- Repair tabs, mounting holes, and slots that are impossible to repair with two-part adhesives
- Completely assembled and ready to go. It is packaged with three Welding Rod Organizer Cases filled with a large selection of welding rods, a hand seamer, aluminum tape, and the BUMPER MATE 2 Workstation.



Features	URT-8202 Nitrogen Tank	URT-8203 Nitrogen Generator
Programmable Start-Up Settings	■	■
Digitally Encoded Temperature Control	■	■
LED Displays for Power Setting	■	■
Single Gas Input (Air or Nitrogen)	■	■
Switchable Dual Gas Input (Air and Nitrogen)	■	■
Automatic Air-to-Nitrogen Switching	■	■
Nitrogen Bottle Regulator and Hose	■	■
6066 Nitrocell Nitrogen Generator	■	■
Precision Flow Valves for Air and/or Nitrogen	■	■
Direct-Reading Precision Flow Gauge	■	■
200W Airless Welder Element with Ceramic Core	■	■
550W Air/Nitrogen Heating Element	■	■

HAS-UNI-8100

Nitro-Weld Plastic Welder

- Built-in compressor
- Contaminate-free nitrogen hot iron/staple capabilities
- Package includes nitrogen welder with both welding + hot staple/reflow torches, professional cart w/cylinder support, starter plastic and staple consumable kit, hand seamer, hot melt blades, aluminum tape, dual gauge regulator w/hose, 80CF nitrogen cylinder
- 115VAC, 50/60Hz single-phase
- Input current: 8 Amps
- Output current: 5-75 Amps @ 4.6 volts
- Gas max. temp.: 950°F (500°C)

H&S
AUTOSHOT



Stud Welders

HAS-UNI-4550 **\$469¹⁵**

Uni-Spotter™ Starter Kit Stud Welder for Steel Panels

- #4551 powerful, economy stud gun: 110V, 1150W
- Pack of 500 2.2mm welding studs
- #1016 deluxe slide hammer
- **2-year warranty**



HAS-UNI-5500 **\$811⁴⁵**

Uni-Spotter™ Stinger Plus Mid-Range Stud Welder Kit for Steel Panels

- #5590 mid-range stud gun: 110V, 1150W
- 2.2mm 2.6mm welding studs, 500 studs of each size
- Tab setter adapter and 100 steel tabs
- #1016 deluxe slide hammer
- Kit includes welding accessories
- **3-year warranty**



HAS-UNI-9000 **\$912³⁵**

Uni-Spotter™ Deluxe Stud Welder Kit for Steel Panels

- #9190 deluxe stud gun: 110V, 1500W
- 2.2mm 2.6mm welding studs, 500 studs of each size
- Tab setter adapter and 100 steel tabs
- #1016 deluxe slide hammer
- Kit includes welding accessories
- **5-year warranty**



Uni-Stud™ Flexpert Universal Welding Studs

- Pack of 500 strong, flexible studs
- Designed for easy welding and easy removal after the pulling is complete



Item #	Size	Application	
HAS-UNI-1001	2.2mm	Regular pulling applications/panel repair	\$26.05
HAS-UNI-1002	2.6mm	Heavy pulling applications/structural repair	\$29.25



HAS-UNI-9700

Dual-Spotter™ Deluxe Aluminum & Steel Stud Gun Kit

- For aluminum and steel panels
- Adjustable output power
- **Kit includes:**
15 ft. torch cable, 115VAC power supply, aluminum & steel studs and pull tabs, tips and weld-tip puller, storage case



MOT-JO1050 **\$472¹⁵**

Magna-Spot™ Entry-Plus Stud Welder Kit

- Magna-Spot™ 1050 gun
- High power, low heat design
- Heavy duty slide hammer
- (500) 2mm draw pins
- (1) Stud electrode
- **5-year warranty**



MOT-JO1500 **\$647²⁵**

Magna-Spot™ Professional Stud Welder Kit

- Magna-Spot™ 1500 gun
- High power, low heat design
- Heavy duty slide hammer
- (500) 2mm draw pins
- (150) Rivets
- (3) Stud electrodes
- **5-year warranty**

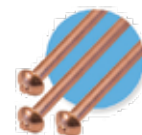

Striker Tip™ Magna-Spot™ Stud Welder Draw Pins

- Pack of 500 strong, flexible studs
- Guarantees a solid weld on all steels



Item #	Size	Application	
MOT-J20014	2.0mm	Regular pulling applications/panel repair	\$25.65
MOT-J20015	2.5mm	Heavy pulling applications/structural repair	\$28.15

Spot Weld Tools & Accessories

DTF-DF-15DX **\$837⁹⁵**

Spot Annihilator Spot Weld Drill

- Depth adjustable
- 3" tall 360° C-clamp
- 1,000 rpm
- (1) 8.0 mm HSCO drill bit
- (2) 8.0 mm Titanium Coated HSCO bits
- (1) 10.0 mm Titanium coated HSCO bit
- (1) Bottle of pneumatic tool oil
- (1) In-line oiler



High Speed Steel Spot Welding Drill Bits



Item #	Diameter x Length	Finish	
MUK-404 008	8mm x 39mm	Titanium Carbon Nitride	\$25.75
MUK-404 408	8mm x 44mm	Titanium Carbon Nitride	\$25.75
MUK-244 806	6mm x 70mm	Titanium Carbon Nitride	\$22.25
MUK-222 308	8mm x 44mm	Carbide	\$106.65
MUK-404 780	8mm x 45mm	Titanium Carbon Nitride	\$25.75
MUK-244 808	8mm x 80mm	Titanium Carbon Nitride	\$22.25
MUK-244 210	10mm x 90mm	Titanium Carbon Nitride	\$23.45

STK-20015 **\$53²⁵**

The Original Heavy-Duty SeamBuster™

- Allows you to separate spot welded or bonded panels
- For quarter panels, rockers and any other pinchweld



MAY-60005 **\$92⁴⁵**

2-Pc Dominator® Spot Weld Breaker Set

- Breaks spot welds or bonded panels
- Metal end caps for striking
- 1" and 1-1/4" blades



SGT-18000 **\$27⁰⁵**

3/8" Rotary Spot Weld Cutter

- Has double ended 3/8" blade
- Arbor fits all 1/4" drills



Sanding Accessories

Dura-Block

DRB-AF44A **\$87⁸⁵**

6-Pc Dura-Block Kit

- (1) AF4400 Standard Block • (1) AF4401 1/3 Block
- (1) AF4402 2/3 Block • (1) AF4404 Round Block
- (2) AF4405 Scruff Blocks



DRB-AF44L **\$117⁶⁵**

7-Pc Dura-Block Kit

- (1) AF4400 Standard Block
- (1) AF4401 1/3 Block
- (1) AF4402 2/3 Block
- (1) AF4403 Full Size Block
- (1) AF4404 Round Block
- (1) AF4405 Scruff lock
- (1) AF4408S Dura-Scrub hand soap bar



DRB-AF44HL **\$149⁷⁵**

7-Pc Dura-Block Kit with Velcro



MOT-SB-1 **\$11⁰⁵**

Soft Block® Flexible Sanding Block

- Double-sided block with two densities
- 2-5/8" x 5-1/4"
- Requires no adhesives
- For wet & dry sanding, colour sanding



Spec-Out Nib Files

- High-quality mini-files easily remove dirt blemishes and runs
- Teeth shave without digging in



Item #	Grain	
STK-35250	Coarse	\$28.05
STK-35260	Fine	\$28.05

Sand Blasters



GOJ-007R **\$102⁴⁵**

Speed Blaster® - Handheld Sand Blaster

- Capacity of 26 oz
- Working PSI: 70 - 100 PSI
- Suggested air compressor: 3 HP



GOJ-HS2020 **\$46⁴⁵**

Hot Spot Recovery System

- Converts your Speed Blaster® into a self-contained spot blast system
- Virtually eliminates blast overspray
- Four blast cones conform to any surface
- All debris are instantly directed into the collection bag



Pinstripe Removers/Surface Preparation Tools



MNT-USSP-02-03 **\$680⁷⁵**

MBX® Metal Blaster® Standard Duty Automotive Starter Kit

- 1 vinyl eraser: for removing vinyl graphics
- 11mm and 23mm coarse belts: for removing rust, paint, undercoating, etc.
- 11mm and 23mm adapters



MBX® Accessories

Item #	Description	
MNT-USBU-030-11	11mm Coarse Carbon Steel Belt	\$25.75
MNT-USBU-030-23	23mm Coarse Carbon Steel Belt	\$25.75
MNT-USZU-010	Vinyl Eraser	\$43.65



MNT-USSP-05-02 **\$1104⁵⁵**

MBX® Die Blaster® Surface Preparation Kit

- Specially designed to remove corrosion in areas that are difficult to reach and to create a "textured/blasted surface" for superior adhesion

Includes:

- Patented accelerator bar for Die Blaster®
- 2 Die Blaster® belts, 11 mm
- 2 Die Blaster® half belts, 11 mm, right
- 2 Die Blaster® half belts, 11 mm, left



DTF-DF-700DX **\$957³⁵**

"Eliminator" – Inline Undercoat & Decal Remover Kit

Includes:

- Decal eraser for water based paint
- Regular decal eraser
- (6) Fiber discs
- (1) Coarse and (1) fine 23mm brush
- (1) Coarse and (1) fine 11mm brush
- Disc and brush holders



DTF-DF-705 **\$52⁸⁵**

Decal Eraser

- Takes away an inch wide strip at a time
- Use with the DF-701 or DF-700DX



DYB-NZ1K **\$689³⁵**

NitroZip – Surface Conditioning/ Decal Pinstrip Removal Tool Kit

- 0.5 HP, 3,500 RPM

Includes:

- (1) 4" x 1/2" Coarse wire wheel
- (1) 4" x 3/4" Coarse wire wheel
- (1) 1-1/4" W x 4" Diam. Red-Tred® Zip eraser wheel



DYB-NZ1 **\$616⁶⁵**

NitroZip – Decal Pinstrip Removal Tool

- 0.5 HP, 3,500 RPM

- (1) 1-1/4" W x 4" Diam. Red-Tred® Zip eraser wheel



Accessories

Item #	Description	
DYB-92255	Red-Tred™ Eraser Wheel 4" Diam. x 1-1/4" Wide	\$62.15
DYB-92245	Coarse Wire Wheel 4" Diam. x 3/4" Wide	\$61.25



IRC-324 **\$263⁰⁵**

Pinstripe Remover

- Comes with (12) 4-inch pads
- 3,700 rpm



AST-32 **\$281⁷⁵**

Pinstripe Removal Kit

- For the removal of pinstripes, adhesive, double faced tape and molding
- Includes (12) 4-inch Smart Eraser® pads (#400E)



AST-400E **\$17⁷⁵**

4" Smart Eraser® Pad

- For the removal of pinstripes, adhesive, double faced tape and molding



AST-400E-AR **\$3⁰⁵**

Arbor for Smart Eraser® Pad



Spray Guns & Paint Accessories



AST-PT2-4GH **\$537⁷⁵**
2-1/4 Gallon Pressure Tank with Spray Gun

- 1.0mm nozzle
- 12 ft. long hoses



AST-2PG8S **\$342⁵⁵**
2L Pressure Pot with Spray Gun and Hose

- 1.7 mm nozzle
- 6 ft. long hoses

\$101⁷⁵

ATD-6810
1 Quart Suction Style All-Purpose Spray Gun

- 1.8mm nozzle



\$91¹⁵

AST-4008
1L Spray Gun with Cup

- 1.8mm nozzle



\$99¹⁵



SUN-SX76
1 Quart High Pressure Spray Gun

- 1.4mm nozzle



\$67⁷⁵



TIT-19418
1L Siphon Feed Production Spray Gun

- 1.8mm nozzle



TIT-20300 **\$219⁰⁵**
2-in-1 HVLP/MP Professional Spray Gun

- 1.4mm nozzle
- Includes: spray gun cleaning kit and optional filter



TIT-20400 **\$392⁷⁵**
High Performance Air Pressure Assist Spray Gun for High Viscosity Materials

- 1.8mm nozzle
- Includes: spray gun cleaning kit and optional filter



\$53²⁵



TIT-19462
Undercoating Spray Gun with 750ml Cup

- 2.5mm nozzle



\$48⁷⁵

TIT-19463
Undercoating Spray Gun

- Handles a wide range viscosity of water or oil based material
- Spray tip opening: 5/16" (7.9mm)
- 1.5" threaded bottle attachment



ATD-6900 **\$270³⁵**



9-Pc HVLP Gravity Feed Spray Gun Set

- Stainless steel needle and nozzle
- Contains:
 - (1) 1.8mm primer spray gun
 - (1) 1.4mm topcoat spray gun
 - (1) 1.0mm touch-up spray gun
 - (2) 1L aluminum cups
 - (1) 125cc stainless steel cup
 - (1) Locking pressure regulator
 - (1) Paint gun filler • Cleaning kit



HVLP Spray Guns

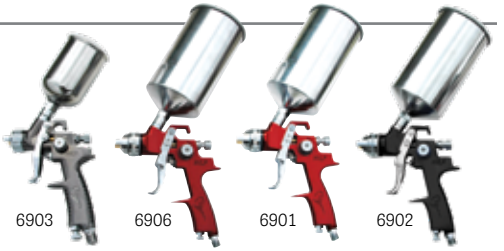

Item #	Nozzle	Cup	Application	
ATD-6903	1.0mm	125cc, Stain. Steel	Touch-Up, Detail Work	\$105.75
ATD-6906	1.3mm	1L, Aluminum	Top Coat, All-Purpose	\$133.75
ATD-6901	1.4mm	1L, Aluminum	Top Coat, All-Purpose	\$128.05
ATD-6902	1.8mm	1L, Aluminum	Primer, All-Purpose	\$137.85

EuroPro High Efficiency Spray Guns with 600 ml Plastic Cup

- Compatible with solvent and waterborne paints

High Efficiency/High Transfer

Item #	Nozzle	
AST-EUROHE103	1.3mm	\$198.15
AST-EUROHE105	1.5mm	\$198.15
AST-EUROHE107	1.7mm	\$198.15
AST-EUROHE109	1.9mm	\$198.15



HVLP Spray Guns

Item #	Nozzle	
AST-EUROHV103	1.3mm	\$202.75
AST-EUROHV105	1.5mm	\$202.75
AST-EUROHV107	1.7mm	\$202.75
AST-EUROHV109	1.9mm	\$202.75



AST-EUROHVT1 **\$187²⁵**
EuroPro HVLP Touch Up Paint Gun with Plastic Cup

- 1.0mm nozzle • 250ml cup capacity
- Compatible with solvent and waterborne paints



LIS-49600 **\$31⁷⁵**
Magnetic Spray Gun Holder



Spray Guns & Paint Accessories



DTF-DF-CR004

CureRIGHT – 66W UV-A LED Rechargeable UV Curing Gun

- For all ultraviolet light curable fillers, base coats, primers, top coats and clear coatings • Fast curing time
- Irradiance: max. intensity of 55,000 $\mu\text{W}/\text{cm}^2$ at 8 inches (20cm)
- Control center with LCD screen • Ultrasonic range finder and timer functions



AST-51SL **\$71⁰⁵**

Rechargeable Lightweight Spray Gun Color Match Light

- Compact, lightweight and universal design affixes to most spray gun nozzle sizes
- 500/250 lumens, 95+ CRI rating and 4000K color temperature
- 90° tilt, 360° rotation
- Hand motion On/Off
- Adjustable light mount tilts to direct light where needed
- USB-C rechargeable



MLW-2127-20 **\$267⁹⁵**

M12™ Paint and Detailing Colour Match Light (Bare Tool)

- 1000 lumens of output with a 98+ colour rendering index to illuminate metallics and imperfections in the paint
- 5 colour temperatures and 3 brightness modes
- Strong magnet for storage



AST-4550A **\$316⁹⁵**

Air Operated Paint Shaker

- Max. capacity: 8.45 pint (1.06 Gallon)
- Accommodates pints, quarts and gallons
- Shaking time: 1.5 minutes
- Speed: 1,400 cycles/min



Astro

500 lbs Capacity Portable Work Stands

- 1/2" foam padded top



Item #	Description	Steel Tubing	Height Adjust.	
AST-557003	Heavy Duty	1"	33" – 40"	\$86.35
AST-557010	Extra Heavy Duty	1-1/4"	35" – 45"	\$96.25

AST-557100 **\$40⁷⁵**

The Fender Extender, 200 Lbs Cap.

- Used with a portable work stand
- 3 way adjustable from 77.5" to 80"



SGT-17280

\$20⁰⁵



Spray Gun Cleaning Kit

- Contains all necessary brushes and tools to effectively clean spray guns including HVLP paint spray guns



MOT-D-12-2 **\$22⁷⁵**

Disposable HVLV Spray Gun Filters

- 1/4" NPT • Max. flow: 30 CFM
- Removal rating: .01 microns
- Pack of 2 filters



MOT-DD1008-2 **\$35⁵⁵**

Disposable Desiccant Spray Gun Filters

- "Change Filter" color indicator • 1/4" NPT
- Max. flow: 20 CFM • Removal rating: 5 microns • Pack of 2 filters

ATD-7812 **\$24²⁵**

Paint Spray Gun Filters

- NPT: 1/4" • Max. flow @ 80 psi: 30 CFM
- Max. pressure.: 100 psi
- Removal rating: .01 microns • Pack of 3 filters



ATD-6926 **\$83⁴⁵**

Locking Air Regulator

- 1/4" fittings
- Adjustment range: 0-150 psi



ATD-6753 **\$32²⁵**

1/4" Air Control Gauge

- Adjusts air pressure at the air tool
- 0 to 160 psi gauge



ATD-6825 **\$125³⁵**

Digital Air Pressure Regulator

- Accurate measurement of air pressure to spray guns or other air tools
- Up to 160 PSI
- Units: PSI, BAR, KG/CM², KPA
- Automatic shut-off • 1/4" universal thread
- Battery-operated



Work Stands

Astro

AST-7300 **\$395⁶⁵**

200 Lbs Capacity Universal Rotating Parts Work Stand

- 8 adjustable bars fit almost any panel, fender, door, hood, or bumper to make repairs and refinishing easy

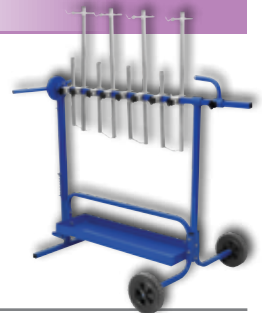

AST-557012 **\$163⁹⁵**

300 lbs Capacity Panel Stand

- Great for working on bumpers and other automotive parts
- Adjustable height of 34.5" to 47"

Astro

Protective Coatings



Raptor® Tough Protective Coating with Spray Gun Applicator

- Ideal for bedliners
- Can be applied to almost any surface, including metal, plastic, concrete and wood
- It's UV resistant so it won't fade
- Doesn't scratch or stain
- Waterproof, chemical proof and rust proof
- Easily applied by spray or roller. Simply fill, shake and apply.
- Can be tinted to any color
- 1 Gallon covers up to 12m²
- 2.6 VOC (volatile organic compound)



Item #	Colour	
UPL-UP0820VG	Black	\$324.15
UPL-UP0821VG	Tintable	\$324.15

Bumper Sensor Service



URT-6149 **\$384⁷⁵**

Parking Sensor Hole Cutting Kit

- Lets you cut perfectly round sensor holes into new and aftermarket bumper covers cleanly and without any distortion or warping
- (6) Cutters for most popular sizes of parking sensor holes: 16mm, 17mm, 18mm, 19mm, 22.5mm, 27mm



Door Tools

STK-21892 **\$53³⁵**

Aluminum Skin Zipper™

- Wide opening for any 1mm aluminum skin and 1.5mm door shell
- Two easy steps: forms the edge of door skin to 45° then finishes the crimp



STK-21896 **\$56¹⁵**

Aluminum Skin Zipper2™

- Allows to reach tighter areas than the original Aluminum Skin Zipper™
- Perfect for aluminum door window flange opening
- Forms the edge of door skin to 45° then finishes the crimp



STK-21890 **\$53²⁵**

Skin Zipper™

- Two easy steps: forms the edge of door skin to 45° then finishes the crimp



STK-21894 **\$53³⁵**

Skin Zipper2™

- For skinning window flanges
- Allows you to hem the narrow window flange in two easy steps



STK-21899 **\$610⁶⁵**

Aluminum Tech Tools Bundle

- #21892: Al Skin Zipper
- #21896: Al Skin Zipper2
- #35000: Soft Strike Aluminum Conversion Kit (35011, 35012, 35015, 35020)
- #35025: Soft Strike™ Hard Cap for Body Hammer
- #35013: Soft Strike™ General Purpose Dolly Cover
- #35017: Soft Strike™ .625 Light Toe Dolly Cover
- #21970 and #21960: SPR (self-piercing rivet) Extraction and Insertion Tools



SGT-82350 **\$113³⁵**

Door Aligner Tool

- Align car and truck doors with either bolted or welded hinges in seconds by using leverage



SGT-87675 **\$34⁹⁵**

Door Spring Tool

- Use to remove and install the door hinge springs found on late model GM cars and light trucks (with larger diameter springs)



STK-21910 **\$36⁴⁵**

Car and Light Truck Door Spring Tool



Upholstery, Trim & Door Panel Tools



CTA-3033 **\$79⁵⁵**
2-Pc VW Roof Grab Release Tool Kit

- Won't damage clips or headliner
 - Kit services but is not limited to: 2013+ Golf, Jetta, Taos, Tiguan & Atlas models
- Includes:
- #1464: for new VW models. Comparable to VW Factory Tool #T10637.
 - #8061: for many VW models. Comparable to VW Factory Tools #T10517, #T10518, #T10518A.



LIS-83060 **\$34²⁵**
22.75" Long Glass Channel Cleaning Tool

- Designed to remove broken glass remnants from glass channels in vehicle doors
- Hooked tip with rounded end to get inside channel lip without damaging the rubber channel



AST-4505 **\$17⁵⁵** **Astro**
5-Pc Fastener & Molding Remover Set

- Non-marring



AST-4524 **\$34³⁵** **Astro**
11-Pc Auto Fastener & Molding Removal Tool Set

- Non-marring



SGT-87860 **\$48⁵⁵**
2-Pc Clip Removal Tool Kit

- Assists with the removal of plastic wheel house, rocker and door molding clips
- Includes: • 21" long offset and 90° angle clip removal tools



SGT-87810 **\$14²⁵**
9" Upholstery Clip Removal Tool

- Removes plastic and metal clips of various shapes and sizes



SGT-87820 **\$12⁴⁵**
7-3/4" Long Tack Puller

- Removes upholstery and trim clips, staples, nails and brads



MUK-277 008 **\$24⁶⁵**
Clip Lifter

- For plastic fasteners, plastic clips, upholstery or door panels



MUK-277 015 **\$133⁵⁵**
5-Pc Clip Lifter Set

- For plastic fasteners, plastic clips, upholstery or door panels



LIS-83700 **\$88⁸⁵**
5-Pc Trim Removal Set



LIS-35400 **\$14⁹⁵**
Door Upholstery Remover for Plastic Fasteners



LIS-35260 **\$18⁰⁵**
Plastic Fastener Remover



LIS-35300 **\$17⁴⁵**
V-Groove Plastic Clip Remover

- For use on upholstery, door panels, radiator shrouds, fender liners and weather stripping



AST-9589 **\$56⁴⁵**
4-Pc Upholstery Tool Set



GWR-84060H **\$69⁵⁵**
4-Pc Door Panel Remover Set



ASM-T280 **\$77⁰⁵**
Omega Clip Pry Lever

- Used to remove Omega clips on Audi/Porsche/VW body panels
- Also applicable to Tesla trunk trim on the Model Y and "Falcon Wing" door trim on the Model X
- Comparable to #T40280



9CL-81910 **\$45¹⁵**
2-Pc Double-Sided Trim Removal Pry Lever & Clip Lifter Tool Set

- For removing exterior and interior trim, molding, dashboards, door panels, and clips
- Metallic material is more durable than plastic panel removal tools



Upholstery, Trim & Door Panel Tools



VIM-BCRP1 **\$64⁴⁵**

Body Clip Removal Pliers

- Easily removes plastic panel and trim clips
- 2-part jaw design provides better support under the clip with large base jaw, while small jaw lifts the clip
- Angled, low-profile spring-loaded jaws for access to tight spaces



OTC-2495 **\$79⁴⁵**

Plastic Clip Popper

- Can be used for nearly any style plastic fastener found on a car, such as: clips, clamps, retainers, grommets, plugs, moldings, stand-offs, vacuum caps, vibration bumpers, etc.



LIS-42810 **\$32⁹⁵**

Plastic Clip Removal Pliers

- Works on plastic push pin type panel fasteners with center pins
- Needle nose design fits into recessed pin locations
- Built-in cutter
- Also used to remove automotive fuses from panel



AST-9581 **\$22⁵⁵**

Precision Panel Clip Pliers

- Slim low profile design for accessing and removing difficult flush fasteners and clips
- Rounded shoulder helps pry fasteners up
- Notched jaw helps prevent snipping off plastic fastener heads



VIM-V2300 **\$159²⁵**

2-Pc Push Pin Removal Pliers Set

- Straight and offset tips



GWR-3729 **\$42⁹⁵**

Push Pin Removal Pliers

- 30° offset



GWR-41840D **\$54³⁵**

2-Pc Push Pin Removal Pliers Set

- 30° and 80° offset push pin pliers



LIS-42070 **\$36⁷⁵**

80° Tip Push Pin Pliers



CAL-54 **\$80⁹⁵**

Adjustable Indexing Trim Clip Pliers

- Removes plastic anchors with center pins without damage to the pin or the anchor



Push Pin & Trim Clip Pliers

- Removes clips without breaking them
- Works on trim pads, hood insulation, etc.



Item #	Head	
STK-21720	Offset	\$50.55
STK-21725	90° Angle	\$50.55



Hog Ring Pliers

Item #	Head	
LIS-61400	Straight	\$38.65
LIS-61410	45° Angle	\$39.35



LIS-60400 **\$15⁵⁵**

Mirror Removal Wrench

- Easily removes mirrors held on by spring clip without damage to the windshield or mirror



TITAN

TIT-15048 **\$19¹⁵**
6-Pc Flexible Multi Wedge Pry Tool Set



LIS-69620 **\$43¹⁵**
5-Pc Non-Marring Wedge Assortment Set



LIS-81950 **\$20⁶⁵**
Non-Marring Molding Strip Removal Tool

- The 3" wide sharp edge easily gets under door moldings and emblems
- Allows use with a mallet on stubborn applications



MUK-277 004 **\$15²⁵**
Non-Marring Combi Wedge, 1" x 8"



Windshield & Window Service Tools

PA Astro

AST-405 **\$48⁵⁵**
Pneumatic Caulking Gun
 • Handles standard cartridge
 • Dispenses caulking,
 adhesives and sealants



AST-WINDKO **\$151⁷⁵**
**ONYX Air Windshield Remover
 with 3-Pc Blade Set**

• 20,000 oscillations per minute
 Includes:
 • #WINDK-08E - 57mm Bent Blade
 • #WINDK-08H - 52mm Bent Curved Blade
 • #WINDK-08J - 35mm Flat-Nose
 Straight Blade

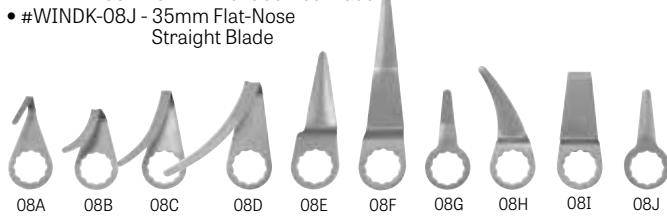

Assorted Blades for #AST-WINDKO

Item #	Blade Description	Size	
AST-WINDK-08A	Hook Blade	24mm	\$25.25
AST-WINDK-08B	Hook Blade	36mm	\$28.25
AST-WINDK-08C	Hook Blade	60mm	\$30.35
AST-WINDK-08D	Hook Blade	90mm	\$33.05
AST-WINDK-08E	Bent Blade	57mm	\$16.95
AST-WINDK-08F	Bent Blade	90mm	\$24.45
AST-WINDK-08G	Round-Nose Bent Blade	35mm	\$27.25
AST-WINDK-08H	Bent Curved Blade	52mm	\$24.05
AST-WINDK-08I	Scraper Blade	48mm	\$27.85
AST-WINDK-08J	Round-Nose Straight Blade	35mm	\$28.25

**Replacement Serrated
 Blade for Use with
 #AST-1770**



Item #	Length	
AST-17705	6"	\$18.75



TOOL AID[®] PROFESSIONAL AUTOMOTIVE TOOLS

SGT-87900 **\$39⁵⁵**
Windshield Removing Tool (Cold Knife)
 • Extra blade supplied with each tool



Windshield Locking Strip Installation Tools

Item #	Shank	
LIS-47000	Straight	\$25.95
LIS-48600	Offset	\$28.25



LIS-35240 **\$34⁶⁵**
**Window Belt Molding
 Remover - Small**
 • Works on moldings
 with or without clips



LIS-35150 **\$22⁸⁵**
**Window Belt Molding
 Remover**
 • Quickly removes all
 window belt moldings

MAY-45049 **\$24⁸⁵**
Window Belt Molding Remover
 • Capped end for striking



LIS-83660 **\$31⁷⁵**
**Windshield Gasket
 Rope Insert Tool**

• Seats the rope under the lip and into groove
 of the rubber windshield gasket
 • Comes with 20 feet of 1/8" nylon rope



LIS-83220 **\$15⁸⁵**
**Windshield Molding Clip
 Removal Tool**

• Can also be used to remove metal
 clips on under hood cowl



LIS-80420 **\$17¹⁵**
**Self-Locking
 Rubber Gasket Tool**

• Rounded steel tip slides the self-locking part
 of the rubber gasket into the locking channel



Antenna Service

LIS-29650 **\$88⁸⁵**
Antenna Nut Socket Set

• Double-ended sockets fit eight common
 domestic & import antenna nuts



Radio Service

OTC-4715 **\$87⁴⁵**
**18-Pc Deluxe European
 Radio Tool Set**

• Set of tools removes radios on most
 European vehicles quickly and easily
 without damaging the radio or dash



Air Riveters



Air Hydraulic Riveters

- Designed to handle structural rivets in aluminum, stainless steel and Monobolt
- On/Off switch for mandrel vacuum collection system

ACA-6410 **\$943⁰⁵**

3/16" Capacity

- Pull force: 2,000 lbs
- Nosepieces: 5/32", 3/16", and 3/16" Monobolt
- Stroke length: 7/8"

ACA-6420 **\$1461¹⁵**

1/4" Capacity

- Pull force: 3,700 lbs
- Nosepieces: 3/16", 1/4", and 3/16", 1/4" Monobolt
- Stroke length: 63/64"



Air Riveters, 1/2 HP

ATD-5850 **\$244⁰⁵**

3/16" Capacity

- Nosepieces: 3/16" (4.8mm), 5/32" (4mm), 1/8" (3.2mm), 3/32" (2.4mm)

ATD-5851 **\$179⁸⁵**

1/4" Capacity

- Nosepieces: 1/4" (6.4mm), 3/16" (4.8mm), 5/32" (4mm), 1/8" (3.2mm)



MAR-39054 **\$407⁰⁵**

M-3 Heavy Duty Air/Hydraulic Riveter

- Stroke: 0.551" (14mm)
- Pulling force: 1,983 lb
- Capacity: 1/8" - 3/16" in all alloys including some structural rivets
- Tool comes with nosepieces, service tools, swivel inlet air coupler and a mandrel collection bottle



SUN-SX1819T **\$710⁶⁵**

1/4" Heavy Duty Rivet Gun

- Includes 3/16" and 1/4" nosepieces
- Pulling (traction) power of 3,960 ft-lb
- Sets all conventional, standard, structural blind rivets, Monobolt, and T-rivets in all materials



CPT-9883 **\$697³⁵**

3/16" Capacity Air Riveter

- Max. pulling load: 1,900 lbs
- Nosepieces: 3/32", 1/8", 5/32", and 3/16" (2.4, 3.2, 4, and 4.8mm)

CPT-9884 **\$1051⁴⁵**

1/4" Capacity Air Riveter

- Max. pulling load: 3,530 lbs
- Nosepieces: 3/16", 1/4", and 1/4" Monobolt (4.8, 6.4, & 6.4mm Monobolt)



Air Riveters, 1/2 HP

AST-PR36 **\$157³⁵**

3/16" Capacity

- 3/16" (4.8mm), 5/32" (4mm), 1/8" (3.2mm), 3/32" (2.4mm)

AST-PR14 **\$193⁶⁵**

1/4" Capacity

- 1/4" (6.4mm), 3/16" (4.8mm), 5/32" (4mm), 1/8" (3.2mm), 3/32" (2.4mm)



AST-PRN1 **\$433⁸⁵**

3/8" Capacity Pneumatic Rivet Nut Setting Kit - Metric & SAE

- Includes 8 mandrels/nosepieces in sizes: M4, M5, M6, M8, M10, 1/4", 5/16", 3/8"
- 2,680 lbs of instant air-hydraulic pulling force
- Max. capacity: M10 (3/8") steel and aluminum rivet nuts, M6 (1/4") stainless steel rivet nuts



AST-PRN2 **\$1025⁹⁵**

1/2" Capacity Automatic Rivet Nut Setting Kit - Metric & SAE

- Automated operation. One pull of the trigger sets and unthreads the tool from rivet nuts up to M12 and 1/2".
- Includes 10 mandrels/nosepieces in sizes: M5, M6, M8, M10, M12, 10-24, 1/4", 5/16", 3/8", 1/2"
- 4,270 lbs of instant air-hydraulic pulling force
- Up to 7mm of adjustable stroke length



Cordless Riveters

MLW-2550-22 **\$497⁹⁵**

M12™ 12V Rivet Tool Kit

- Pulls 3/32", 1/8", 5/32", 3/16" rivets in aluminum, steel and stainless steel materials
- Pull force: 2,000 lbs
- (2) M12™ 12V CP1.5 batteries
- (1) Charger



MLW-2660-22CT **\$1447⁹⁵**

M18™ 18V Blind Rivet Tool Kit

- Installs 3/16", 7/32", 1/4", 9/32" rivets in aluminum and stainless steel materials
- Pull force: 4,500 lbs • Stroke: 1.18"
- (2) M18™ 18V CP2.0 batteries
- (1) Multi-voltage Charger



MLW-2550-20 **\$317⁹⁵**

M12™ Riveter (Bare Tool)



MLW-2660-20 **\$1197⁹⁵**

M18™ Blind Rivet Tool (Bare Tool)



Hand Riveters

MAR-39000 **\$61⁹⁵**

HP-2 Hand Riveter

- The HP-2 is the number one selling hand rivet tool in the industry
- Sets up to 3/16" steel rivets
- Comes with four mounted nosepieces (3/32", 1/8", 5/32" and 3/16") and a service wrench



marson

MAR-39010 **\$326²⁵**

Big Daddy® Hand Riveter

- Includes 3/16", 1/4" nosepieces and special 1/4" Klik-Split rivet nosepiece



TOOL AID
PROFESSIONAL AUTOMOTIVE TOOLS

19800

19830

1/4" Super Duty Riveters

- Easily sets five sizes of aluminum and steel rivets: 1/8" (3.2mm), 5/32" (4.0mm), 3/16" (4.8mm), 7/32" (6.0mm) and 1/4" (6.4mm)

Item #	Nose Reach	
SGT-19800	2-1/4"	\$100.45
SGT-19830	5-3/4"	\$142.95

ATD-5842 **\$64⁷⁵**

1/4" Heavy Duty Hand Riveter

- 5 nosepieces to set steel & aluminum rivets: 1/8" (3.2mm), 5/32" (4.0mm), 3/16" (4.8mm), 7/32" (6.0mm) and 1/4" (6.4mm)
- Overall length: 20-3/4"
- Nose length: 2-1/4"



ATD

ATD-5835 **\$79³⁵**

13" Heavy Duty Hand Riveter

- Nosepieces: 1/8" (3.2mm), 5/32" (4.0mm), 3/16" (4.8mm), 7/32" (6.0mm), 1/4" (6.4mm)



Astro

AST-1455 **\$171¹⁵**

Metric & SAE Hand Rivet Stud Setter Kit with Rivet Studs

- Sets the following sizes and includes 5-pc each 5/8" long threaded rivet studs: M5, M6, M8, 10-24, 1/4-20 & 5/16-18

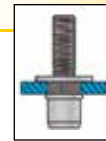

AST-1451 **\$156⁰⁵**

10" Micro Rivet Nut Setter Kit

- Mandrels, nosepieces and rivet nuts in: 10-24, 1/4-20, 5/16-18, M5, M6 and M8
- Includes 10-pc rivet nuts of each included size

Astro



AST-1442 **\$166¹⁵**

13" Nut/Thread Setting Hand Riveter Kit

- 6 interchangeable mandrel/nosepiece sets in: M5, M6, M8, 10-24, 1/4-20, and 5/16-18
- 10-pc rivet nuts per thread size

Astro



AST-1450 **\$170⁰⁵**

13" PlusNut & Extra-Long Rivet Nut Setter Kit

- SAE: 10-32, 10-24, 1/4-20, 5/16-18, 3/8-16
- Metric: M5x0.8, M6x1, M8x1.25, M10x1.5
- Includes #1442 nut setting tool

Astro



AST-1452 **\$172³⁵**

XL Nut/Thread Setting Hand Riveter Kit, 1/2" Capacity

- 6 interchangeable mandrel/nosepiece sets in: M8, M10, M12, 5/16", 3/8", 1/2"
- Includes 10-pc rivet nuts of each included size



Astro

Hand Riveters

AST-1453 **\$160⁶⁵**  **Combination Rivet Nut & Pop Rivet Setter Kit**

- Attachments for blind rivet sizes in: 3/32" (2.4mm), 1/8" (3.2mm), 5/32" (4mm), 3/16" (4.8mm), and 1/4" (6.4mm)
- Attachments for rivet nuts in: M5, M6, M8, 10-24, 1/4", 5/16"



SGT-19400 **\$44⁷⁵**  **Rivet Tool for Plastic Rivets**

- Sets most plastic rivets in one stroke without re-gripping
- Sets all sizes using a single nosepiece



AST-1443B **\$85⁰⁵** **7.5" Professional Metric & SAE Rivet Nut Setter**

- Includes rivet nut assortment and sizes M4, M5, M6, 8-32, 10-24 and 1/4-20



DTF-DF-CT887 **\$166⁵⁵** **Slimline Plastic Riveter Kit**

- Compact plier is 1" tall and requires 2" clearance to fully pull rivets
- Kit includes:
 - (10) 5.0mm plastic rivets (#CT887RS)
 - (10) 6.3mm plastic rivets (#CT887RL)



HP-4x4™ Multiplex Hand Tool Kits

- New, patented design that allows this single tool to set in a variety of sizes of both aluminum and steel material rivets and rivet nuts



MAR-M39410 **\$149²⁵** **HP-4x4™ Inch Size**

- Installs:
- Blind rivets up to 3/16" diameter
 - Rivet nuts up to 1/4-20 size
 - MET series external thread stud rivet bolts up to 1/4-20
 - Jack nuts (MQN)
- Includes:
- 4 nosepieces: #6, #8, #10, 1/4
 - 5 threaded mandrels: 6-32, 8-32, 10-24, 10-32, 1/4-20
 - 3 threaded sockets: 8-32, 10-24, 10-32

MAR-M39411 **\$149²⁵** **HP-4x4™ Metric Size**

- Includes:
- 4 nosepieces for blind rivets: 2.4mm, 3.0/3.2mm, 4.0mm, 4.8/5.0mm
 - 4 threaded rivet nut mandrels: M3, M4, M5, M6
 - 2 threaded sockets for rivet studs: M4, M5

CTA-8982 **\$174⁸⁵** **Chain Breaker & Riveting Tool Kit**

- Will break chains from #35 to #530, including cam chains & drive chains
- Applications:**
- 2.2mm pin: most cam chains
 - 2.9mm pin: #25 or #35 chains
 - 3.8mm pin: #428 to #530 chains (most motorcycle drive chains)



OTC-4738 **\$215⁰⁵** **Chain Breaker & Riveting Tool Kit**

- Breaks, presses, and rivets #415 - #632 size standard and O-ring chains



MAR-39302 **\$192²⁵** **Poly-Nut Rivet Nut Tool Kit - SAE**

- #39300 Rivet Nut Tool
- Mandrels and nosepieces: 8-32, 10-32 and 1/4-20
- 52 assorted Klik Poly-Nuts: (12) 8-32; (12) 10-24; (12) 10-32; (16) 1/4-20



MAR-39303 **\$224²⁵** **Poly-Nut Rivet Nut Tool Kit - Metric**

- #39300 Rivet Nut Tool
- Mandrels and nosepieces: 4, 5, 6, 8mm
- 75 assorted Klik Poly-Nuts: (25) 4mm; (25) 5mm; (15) 6mm; (10) 8mm



MAR-48005 **\$89¹⁵** **Klik-Lok™ KL-2 Plastic Rivet Setter**

- Long-reach tool is ideal for hard-to-reach spots
- One-stroke setting
- Universal nosepiece sets all plastic rivets



OTC-4744 **\$158⁸⁵** **Chain Breaker & Riveting Tool Kit**

- Breaks, presses, and rivets most #25 - #35 and #428 - #630 size standard and O-ring chains



Power Riveting Adapters

Rivet Nut Drill Adapter Kits

- Converts your drill into a power rivet nut setter



AST-ADN14 **\$182¹⁵**

- Includes: M3, M4, M5, M6, 8-32, 10-32, 10-24, 1/4-20

AST-ADN38 **\$201¹⁵**

- Includes: M5, M6, M8, M10, 10-24, 1/4-20, 5/16-18, 3/8-16



HEAT GUNS / FLAMELESS HEAT TOOLS / TORCHES

Heat Guns



Proheat® STC™ Heat Gun

- Variable temperature control: 90°-500°F/40°-270°C
- 4 - 16 CFM
- 1,300W, 11A



Item #	Cord	
MAS-PH-1600K	6 ft.	\$931.85
MAS-PH-1615K	15 ft.	\$952.45



Variable Temperature Heat Gun

- Variable temperature: 110°F to 930°F
- 5 CFM & 9 CFM
- 1,200 Watts
- 6 ft. cord
- Kit #EC-200K includes: 4 attachments, flat metal scraper, scraper handle with 3 interchangeable blades



Item #	Description	
MAS-EC-200K	Kit	\$116.95
MAS-EC-200	Heat Gun Only	\$81.45



Master® HG T-Series Lightweight Heat Guns

- 120V • 27 CFM • 6 ft. cord, grounded
- Lightweight, impact resistant plastic housing
- Ergonomic soft grip handle
- Lightweight, anti-slip plastic stand offers stable 90-degree adjustability



Item #	Temperature	Amps	Watts	
MAS-HG-201T	400°F (204°C)	5A	600W	\$294.75
MAS-HG-301T	800°F (426°C)	12A	1440W	\$290.15
MAS-HG-501T	1200°F (649°C)	14A	1680W	\$290.25

Industrial Heat Guns

- 120V • 27 CFM • 6 ft. cord, grounded
- Die cast aluminum housing
- Ergonomic soft grip handle
- Non-slip, reinforced stand offers stable 90-degree adjustability



Item #	Temperature	Amps	Watts	
MAS-HG-501D	1200°F (649°C)	14.5A	1740W	\$291.05
MAS-HG-801D*	1400°F (760°C)	18.5A	2220W	\$304.25
MAS-VT-751D	Variable Temp.: 100°F - 1200°F (38°C - 649°C)	14.5A	1740W	\$372.05

* HG-801D is equipped with a NEMA 5-20P plug, requires a 20A outlet.

TIT-22406 **\$49⁰⁵**

9" Long Mini Heat Gun

- Max. temp.: 662° F (350° C)
- 350W, 120V
- Air flow: 9.9 CFM (280 l/min)
- Folding stand & heat deflector
- 6 ft. cord



TIT-22400 **\$43⁶⁵**

Dual Temperature Heat Gun

- Low/High setting: 572° F / 932° F
- 12.5 Amps
- 750W/1,500 W
- 6.5 ft. cord



ATD-3736 **\$99⁶⁵**

Dual Temperature Heat Gun Kit

- Low/High setting: 700°F/925°F
- 1,000W/1,500W



AST-9426 **\$150⁴⁵**

Industrial Heavy-Duty Heat Gun

- Variable temp. adjustment: 1,000-1,100°F
- Powerful blower: 23 cfm
- 1,600 Watt, 13A
- Cool air setting
- Three position non slip steel base



MLW-2688-20 **\$177⁹⁵**

M18™ Compact Heat Gun (Bare Tool)

- High performance heating coil reaches operational temperature in less than 7 seconds
- Temperature: 875°F (468°C)



DEW-DCE530B **\$139⁶⁵**

20V MAX* Cordless Heat Gun (Bare Tool)

- (2) Temp. settings: 990°F/550°F
- 6.7 CFM
- Lock-on/Lock-off trigger
- LED light • Includes 2 nozzles



IRO-HG-400W **\$168⁴⁵**

Professional Propane Heat Gun Head

- Automatic ignition
- Flame temp.: 450-550°C / 842-1,022°F
- Includes deflector and spread nozzles
- Uses long lasting propane cylinder (not included)



Induction Heaters

Mini-Ductor® Handheld Induction Heaters & Flameless Torches

The flameless, Invisible Heat® solution for fast, safe and damage free removal of stubborn or frozen nuts and bolts from corrosion or thread-lock compounds, exterior trim, vinyl graphics, bonding, glass, and much more.



Warranty:
1-yr on power unit
2-yr on attachm.



IND-PM-20000 Inductor® Pro-Max® Induction Heater

- Using high frequency magnetic fields, heat ferrous metals without collateral damage to nearby plastic parts
- Remove ALL types of adhesives bonded to metal, release seized hardware from corrosion or thread lock compounds, remove body caulking
- Remove bonded glass and windshields
- Includes:
 - Concentrator® (U-411),
 - Glass Blaster® (U-311),
 - Fast-Off® Pad (U-211)



IND-GB-20311 \$1492⁰⁵ Inductor® Glass Blaster®

- Removes auto glass from outside the vehicle in minutes with no need to remove the interior trim
- There is no damage to the encapsulant or frit (blackout masking)
- Remove windshields in 15 minutes, back glass in 9 minutes, and quarter glass in 3 minutes
- You can also remove spray-in bed liners in just a few hours



IND-MD99-604 \$103⁷⁵ Mini Pad Attachment

- Quickly remove decals, graphics, pinstripes, emblems, and body side moldings by heating the ferrous metal underneath
- Softens spray paint to easily wipe off
- No need for solvents



IND-U-111 \$262²⁵ Paintless Dent Removal Baton Attachment

- Uses Invisible Heat® method for the cleanest and fastest way of fixing hail dents, door dings and other minor soft dents



IND-MD-500 \$854⁶⁵

Mini-Ductor® - 12V, 840 Watts

- 12V battery clamps works off a jump pack or a vehicle's 12V battery
- 9-ft cables
- Includes:
 - 7/8" pre-formed coil (MD99-601),
 - U-form coil (MD99-602),
 - 1" pre-formed coil (MD99-610)



IND-MD-700 \$632⁶⁵

Mini-Ductor® II - 110V, 1000 Watts

- Includes:
 - 7/8" Pre-formed Coil (MD99-601),
 - U-form Coil (MD99-602),
 - Bearing Buddy Coil (MD99-603)



IND-MDV-777 \$759⁴⁵

Mini-Ductor® Venom™ - 110V, 1000 Watts

- Angled design
- Coil twist lock • Trigger switch
- Cooling enhancement
- Fault override delay
- Includes:
 - 7/8" Pre-formed Coil (MD99-601),
 - U-form Coil (MD99-602),
 - Bearing Buddy Coil (MD99-603)



IND-MDV-787 \$822⁸⁵

Mini-Ductor® Venom® HP - 120V, 1800 Watts

- Highest powered available, 90% faster
- LED usage indicator
- Fan operation enhancements
- Includes:
 - 7/8" Pre-formed Coil (MD99-601),
 - U-form Coil (MD99-602),
 - Bearing Buddy Coil (MD99-603)

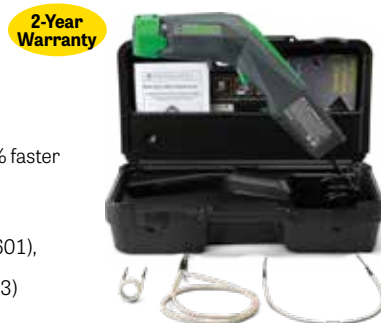

HEAT GUNS / FLAMELESS HEAT TOOLS / TORCHES

Induction Heaters



Mini-Ductor® Coil Accessories & Kits

Item #	Description	
IND-MD99-660	8-Pc Essential Coil Kit (Contains 6 Standard Coils and 2 Long Coils)	\$156.25
IND-MD99-650	8-Pc Standard Coil Kit	\$192.95
IND-MD99-675	8-Pc Long Coil Kit	\$238.25
IND-MD99-644	4-Pc Thin Wall Coil Kit (3/4", 13/16", 7/8", 1")	\$78.75
IND-MD99-643	3-Pc Bearing Buddy Coil Kit (41" & 96" Flexible Coils and Heat Resistant Mat)	\$114.95
IND-MD99-612	Heat Resistant Mat (Extends the life of the Bearing Buddy Coils)	\$13.15
IND-MD99-603	41" Bearing Buddy Coil	\$44.65
IND-MD99-606	1/2" Standard Pre-Formed Coil	\$26.25
IND-MD99-601	7/8" Standard Pre-Formed Coil	\$22.35
IND-MD99-605	7/8" Long Pre-Formed Coil	\$24.25
IND-MD99-611	3/4" Standard Pre-Formed Coil	\$22.35
IND-MD99-629	3/4" Thin Wall Pre-Formed Coil	\$22.95
IND-MD99-631	13/16" Thin Wall Pre-Formed Coil	\$22.95
IND-MD99-632	7/8" Thin Wall Pre-Formed Coil	\$22.95
IND-MD99-610	1" Standard Pre-Formed Coil	\$26.95
IND-MD99-635	1" Thin Wall Pre-Formed Coil	\$22.95
IND-MD99-609	1-1/4" Standard Pre-Formed Coil	\$27.55
IND-MD99-608	1-1/2" Standard Pre-Formed Coil	\$28.25
IND-MD99-607	1-3/4" Standard Pre-Formed Coil	\$28.85
IND-MD99-602	U-Formed Coil	\$17.05

Propane Torches



VCT-0387-0400 **\$85⁸⁵**

AirFuel MP-90 Manual Light Hand Torch – Propane & MAP/Pro™

- Suitable for brazing, heating and soldering
- 360° swivel tip
- For use with disposable 14.1 oz. or 16 oz. Propane or MAP/Pro™



VCT-0387-0463 **\$96²⁵**

AirFuel SMP-43 Hand Torch – Propane & MAP/Pro™

- Pressure regulated for pre-set flame
- Suitable for brazing, heating and soldering
- Auto igniter for instant flame
- Trigger lock on button
- For use with disposable 14.1 oz. or 16 oz. Propane or MAP/Pro™



MAS-PT-2000SI **\$75⁸⁵**

Heavy Duty, High Intensity Propane Torch Head

- Push button ignition
- Can be used with Propane (flame burns at 3,600°F) or MAPP Gas (flame burns at 3,730°F)
- Cast aluminum housing
- Safety lock
- Flame lock push button for continuous use
- Use with standard Propane or MAPP Gas cylinders



CLP-580500 **\$32⁵⁵**

Spark-Key™ Torch Ignitor

- Ignites all butane, propane, & gas torches
- 100,000 sure-fire sparks
- Water-resistant
- No batteries required



HEAT GUNS / FLAMELESS HEAT TOOLS / TORCHES

Butane Torches



MAS-MT-76 **\$75⁸⁵**

Butane-Powered Microtorch®

- Flame temperature: up to 2,500°F/1,300°C
- Includes soldering tip and hot air tip for soldering up to 752°F/400°C
- 120 minutes continuous run time
- Removable base for table-top or hand-held use



MAS-MT-70 **\$35¹⁵**

Butane-Powered Mini Microtorch®

- Flame temperature: up to 2,500°F/1,300°C
- 60 minutes continuous run time
- Removable base for table-top or hand-held use



MAS-MT-51 **\$44⁹⁵**

Self-Igniting Butane Microtorch®

- Flame temperature: up to 2,500°F/1,300°C
- Adjustable broad or pinpoint flame
- 120 minutes continuous run time



POR-011880070 **\$82⁸⁵**

Medium Power Butane Torch

- Adjustable 50-220 Watts
- Adjustable flame length up to 3-1/2"
- Flame temperature up to 2,462°F (1,350°C)
- Powerful, wind resistant flame



POR-012680040 **\$92¹⁵**

High Power Butane Torch

- Adjustable 50-820 Watts
- Adjustable flame length up to 4-1/2"
- Flame temperature up to 2,462°F (1,350°C)
- Powerful, broad wind resistant flame



PT-500



PT-210TCR



PT-220

Butane Torches

- Automatic Piezo ignition

Item #	Description	
IRO-PT-500	Heavy Duty Butane-Powered Pro-Torch™ • Separate controls for fuel & air • 200 minutes continuous run • Flame temp: 1,350°C	\$97.65
IRO-PT-210TCR	Professional 3-in-1 Butane-Powered Pro-Torch™ • Works as: Torch, soldering iron or a hot blower • Flame temp: 1,300°C / 2,400°F	\$97.15
IRO-PT-220	Professional Butane-Powered Pro-Torch™ • Separate controls for fuel & air • Adjustable flame • Flame temp: 1,350°C / 2,462°F	\$89.25



WEL-ML200 **\$61⁶⁵**

Magna-Lite Butane Torch

- Piezo electronic ignition
- Adjustable flame height
- Flame temperature: up to 2,400° F
- Up to 60 minutes continuous use



PPMT



PPMTKIT01



Butane-Powered Micro Torch

- Electronic ignition
- Flame adjustment
- Max. temperature: 2,500°F (1,300°C)

Item #	Model	
PWP-PPMT	Torch Only	\$74.65
PWP-PPMTKIT01	Torch and Tip Kit	\$144.15

Butane Fuel



MAS-10449 **\$8⁴⁵**

Ultratane® Butane Fuel

- 2 oz. canister with universal tip adapter



Soldering Irons



MAS-PI-20SIK **\$63¹⁵**

Butane Powered Soldering Iron/Flameless Heat Tool/Torch Kit

- Soldering temp: 680°F – 820°F (360°C – 438°C)
- Power equivalent: 167W
- Max. 60 min. run time
- Includes: 4 soldering tips, flameless heat shrink adapter, hot knife tip, lead-free solder



MAS-UT-100SIK **\$200⁹⁵**

Ultratorch® Butane Soldering Iron

- Soldering temp.: 482° - 932°F (250° - 500°C)
- Power equivalent: 20-80W
- 2 hours continuous run time
- Includes: soldering tip, hot air tip, shrink attachment



MAS-UT-200SI **\$266¹⁵**

Ultratorch® High-Powered Butane Soldering Iron/Heat Tool/Torch

- Soldering temp.: 482°F - 986°F (250°C - 530°C)
- Power equivalent: 200W
- 2.6 hours continuous run time
- Includes: soldering tip, hot air tip, shrink attachment



WEL-WLIR6012A **\$51⁵⁵**

60W Soldering Iron with LED Halo Ring™

- Temperature: 880°F (470°C)
- 6mm (1/4") tip size
- High visibility 360° LED Halo Ring™ • Integrated safety rest



WEL-PSI100K **\$236⁸⁵**

Super-Pro® Self-Igniting Butane Soldering Iron Kit

- Power equivalent: 125W
- Adjustable temperature up to 1076° F (580° C)



WEL-WLBUK75 **\$191²⁵**

Self-Igniting Cordless Butane Soldering Iron & Heat Tool Kit

- Power equivalent: 25-75W
- Soldering temperature up to 1076° F (580° C)



WEL-WSTA3 **\$310⁶⁵**

Pyropen® Professional Cordless Butane Soldering Iron

- Temperature range: 392°F - 932°F (200°C - 500°C)
- Power equivalent: 20-80W • Ready to use in 30 seconds



\$93³⁵

POR-010289140

Model P-1K – Professional Butane Soldering Iron Kit

- Cordless flint ignition
- **Adjustable power 10-60 Watts**
- Includes 4 tips



Tips for Model #P-1

Item #	Model	Tip Size	Tip Descr.	
POR-010288000	T-1	1/32" (1.0mm)	Single Flat	\$11.85
POR-010288010	T-2	3/32" (2.4mm)	Single Flat	\$11.85
POR-010288020	T-3	1/8" (3.2mm)	Single Flat	\$11.85
POR-010288030	T-4	3/16" (4.8mm)	Single Flat	\$11.85
POR-010288060	T-5		Flame Tip	\$11.85
POR-010288050	T-6		Hot Air Tip	\$11.85
POR-010288040	T-7		Knife Tip	\$11.85



\$183⁷⁵

POR-010589330

SuperPro Butane Soldering Iron

- Self-igniting
- **High power adjustable 25-125 Watts**
- Melts solder in less than 30 seconds from ignition
- Flameless combustion (solder and hot air modes)
- Includes 7 tips



Tips for Model #SP-1

Item #	Model	Tip Size	Tip Descr.	
POR-011188000	SPT-1	1/32" (1.0mm)	Single Flat	\$14.85
POR-011188010	SPT-2	3/32" (2.4mm)	Single Flat	\$14.85
POR-011188020	SPT-3	1/8" (3.2mm)	Single Flat	\$14.85
POR-011188030	SPT-4	3/16" (4.8mm)	Single Flat	\$14.85
POR-011188040	SPT-5	1/32" (1.0mm)	Double Flat	\$14.85
POR-011188050	SPT-6	3/32" (2.4mm)	Double Flat	\$14.85
POR-011188060	SPT-7	1/8" (3.2mm)	Double Flat	\$14.85
POR-011188070	SPT-8	3/16" (4.8mm)	Double Flat	\$14.85
POR-011188090	SPT-10		Hot Knife	\$14.85
POR-011188480	SPT-13		Hot Air & Deflector	\$17.85



Soldering Irons

POWER PROBE

PWP-PPSK **\$94⁷⁵**

Butane-Powered Soldering Kit

- Electronic ignition
- Adjustable flame control
- Max. temp.: 950°F (510°C)



POWER PROBE

PWP-PPPS50W **\$156⁰⁵**

Pro-Solder 50W Rechargeable Soldering Iron

- Max temperature: 1,112°F
- Run time: 35 minutes
- Includes point tip, chisel tip, heat shrink tip, 10g lead free solder, USB charging cable



Milwaukee

MLW-2488-21 **\$197⁹⁵**

M12™ 12V Rechargeable Soldering Iron Kit

- Max. temperature: 750°F
- (1) Pointed tip and (1) chisel tip
- (1) 12V 2.0 compact battery
- (1) Li-Ion charger



MLW-2488-20 **\$94²⁵**

M12™ 12V Soldering Iron Kit (Bare Tool)



Lenk

Q30SI

Q30HS

Quick FX3 – Cordless Rechargeable Li-Ion Heat Tools

- Quick charge, quick heat and quick change
- Includes cap, safety stand and USB charging cable



Item #	Description	Tip Temperature	Run Time	
WAL-Q30SI	30W Soldering Iron	1,100°F	40 Minutes	\$48.05
WAL-Q30HS	30W Heat Shrink Tool	600°F	45 Minutes	\$48.05
WAL-Q30HK	30W Hot Knife Tool	1,100°F	200 Cuts	\$46.45

Soldering Guns

Lenk

WAL-LG2500K **\$60⁰⁵**

100 Watt Light Duty Soldering Gun

- For fine, intricate soldering
- Max. tip temperature: 750°F
- Integral tool stand
- Includes 2 soldering tips and 6 g lead free rosin core solder



Lenk

LG550

LG400C

Trig-R-Heat Heavy Duty Soldering Guns

- Dual wattage elements
- Large built-in 1" work light
- #LG400C comes in a blow molded case



Use continuously without the need to let the tool rest!

Item #	Dual Elements	Max. Temp.	Pyramid Tip	
WAL-LG400C	150/400 Watts	1000°F	1/4" Diam.	\$176.45
WAL-LG550	300/550 Watts	1000°F	1/2" Diam.	\$204.85

Weller

9400PKS

D550PK
D650PK

Dual-Soldering Gun Kits – 120 Volt

- 6-second heat up
- Built-in LED lights
- Kits come in a blow molded case and include a coil of lead-free solder



Item #	Dual-Watt	Temperature	Tips	
WEL-9400PKS	140/100W	High to medium Max. 900°F (482°C)	3	\$100.85
WEL-D550PK	260/200W	1,100°F/900°F (482°C/593°C)	3	\$145.95
WEL-D650PK	300/200W	1,100°F/900°F (482°C/593°C)	1	\$185.15

ATD-3740 **\$134⁸⁵**

8-Pc 120V Dual Heat Soldering Gun Kit

- Produces 230W or 150W
- Includes: (2) soldering tips, (1) cutting tip, (1) flux brush, 15 g of lead-free solder

ATD



ATD-8235 **\$60⁵⁵**

Automotive Acid Brush

- Brush width: 3/8"
- Brush trim: 3/4"
- Brush length: 6"
- Box of 144 brushes



ATD

Welding & Cutting Equipment

GDL-282037



EPEQ™ 140A Lithium Battery Powered Portable Stick Welder (SMAW)

- Lightweight design at only 34 lbs
- Dimensions: 18.3" L x 7.6" W x 14.9" H
- Constant current welding capabilities
- Hot start for easier welding
- Duty cycle: 20% 140A, 50% 110A, 100% 80A
- Can weld 10-12 pieces of 1/8" (3.2mm), or 20-25 pieces of 3/32" (2.5mm) welding rods on a full charge



- Input voltage: 100V-240V, 50/60Hz
- Two charge modes: 1.5-hour fast charge and 3-4 hours standard charge
- Lead length: 10 feet
- Waterproof, dust proof, shock proof, rugged and durable battery pack
- Built-in protections: over charge, overload, high temperature, short-circuit
- Certifications: UN38.3, RoHS, CE



HAS-HSW-6321



Professional Inverter AC/DC Pulse TIG Welder

- For aluminum & steel alloys
- Provides 30-200 Amps of power
- 115V/230V dual voltage
- Digital modes control
- 10 Program memory



MIG Welders

- 140 Amps = 1/4" welding capacity
- 200 Amps = 3/8" welding capacity
- AL spool gun ready

Item #	Amps	
HAS-HSW-6214	140A	\$1124.75
HAS-HSW-6220	200A	\$1374.75



HAS-HSW-6420-03



MultiMIG Synergic Welder

- 200 Amps = 3/8" welding capacity
- 115V/230V dual voltage
- 16 Synergic MIG programs
- MIG, TIG, and Stick included



HAS-HSW-6004



40A Plasma Cutter

- 1/2" clean cut @ 230V
- Dual voltage 115V/230V



HAS-HSW-6213 **\$862¹⁵**

130A MIG Welder

- 3/16" Welding capacity
- 115V Inverter power supply



HAS-HSW-7020 **\$595⁹⁵**

220A Spool Gun

- 20-Ft. coaxial cable
- For aluminum or steel welding



HAS-HSW-7000 **\$271⁹⁵**

Welding Cart

- Features 3 shelves, Shield gas cylinder support and large casters



TITAN SHOP IRON

TIT-41200 **\$1208⁹⁵**

30 Amp Portable Plasma Cutter

- Dual voltage: 115V/230V AC
- Cuts mild steel, stainless, brass, aluminum and other conductive materials
- Cutting capacity:
 - 1/4" (6.4 mm) clean cut on mild steel
 - 1/2" (12.7 mm) rough sever
- Weight: 21 lbs



TITAN VAPER

TIT-41185 **\$510⁸⁵**

90 Amp Gasless Wire Feed Welder

- Perfect for light duty repairs, maintenance and fabrication
- Welds up to 1/8" thick mild steel (not suitable for aluminum)
- Uses 0.030" to 0.035" diameter flux-core wire
- Operates on 120V single phase power
- Fan cooled for better performance



Welding & Cutting Equipment



3130
3175



ATD-3130K
ATD-3175K



3198

3716

7041

Professional MIG/Flux Core Welder Kits

- Welds steel, stainless steel, aluminum and cast iron
- Multiple power settings and infinite wire speed
- Fan-cooled power unit and thermal overload protection
- 10 year transformer warranty, and 1 year on all other parts

ATD-3130K & ATD-3175K kits include:

- 7 ft. Tweco-Type MIG gun with .030" (0.8mm) contact tip
- 6.5 ft. heavy duty work cable & clamp
- 0.035" (0.9mm) flux core wire starter spool and contact tip
- 0.023" (0.6mm) solid core wire starter spool and contact tip
- 6' 5" power cord
- Wire brush/hammer combo tool
- Welding mask with DIN 11 shade lens (ATD-3716)
- Cart (ATD-7041)
- Regulator (ATD-3198)

Welder Kits

Item #	Peak Amp Power	Duty Cycle	Input Voltage	
ATD-3130K	40-130 Amp	40% @ 60A @ 21V	120 Volt	\$1374.25
ATD-3175K	35-175 Amp	25% @ 120A @ 20V	230 Volt	\$1542.45

Welder Accessories

Item #		
ATD-3198	Welding Regulator	\$120.85
ATD-7041	MIG Welding Cart	\$180.75



VCT-1444-0346 **\$2041⁹⁵**

FP-135 MIG/Flux Cored Welder

- Maximum output: 135 Amp
- Duty cycle @ 140°F: 40% @ 90 Amp at 18V
- Current range: 20-135 Amp
- Number of voltage settings: 4
- Maximum plate thickness: 1/4" (6.4mm)
- Wire diameter range: .023" - .035" (0.6 - 0.9mm)
- Maximum input current: 50A

Package includes:

- FP135 MIG welder • MIG welder cart • Wire brush
- Auto-darkening helmet • Chipping hammer • Regulator



VCT-1444-0328 **\$2043⁷⁵**

FP-165 MIG/Flux Cored Welding System

- Maximum output: 165 Amp
- Input plug: 208/230VAC, 50A
- Duty cycle @ 140°F: 20% @ 130 Amp at 30V
- Current range: 20-165 Amp
- Number of voltage settings: 4
- Maximum plate thickness: 1/4" (6.4mm)
- Wire diameter range: .023" - .035" (0.6 - 0.9mm)
- Maximum input current: 35A

Includes:

- Tweco Gun • Return cable & clamp
- 6 ft. power cord • .030" spool of flux-cored wire



VCT-1444-3200 **\$1910⁵⁵**



MST-200 Multi-Process MIG/Stick/DC TIG Welding System

- Designed to tackle steel, stainless and aluminum projects
- Max. output: 10 - 200 Amps
- Dual voltage: 120V/230V
- Power to run Stick electrodes up to 5/32" (4mm)
- Digital controls

Package includes:

- Tweco Fusion 180 Velocity MIG gun with Tweco connection and Velocity consumables
- Tweco 17V TIG torch with 50mm dinse and accessory kit
- Electrode holder • Ground clamp • Argon/CO2 regulator
- Power adapter • Sample wire spool



VCT-0384-0944 **\$987⁸⁵**

G150 - Light Duty Cutting & Welding Portable Tote Outfit

- Cuts up to 1/4" (6.4mm) or up to 5" (127mm) with optional tips
- Welds up to 5/64" (2mm) or up to 1" (25.4mm) with optional nozzles
- Tanks are delivered empty



VCT-0384-2580 **\$696³⁵**

Medalist® 250 CLASSIC - Medium Duty Cutting & Welding Outfit

- Cuts up to 1/2" (12.7mm) or up to 5" (127mm) with optional tips
- Welds up to 5/64" (2mm) or up to 1.25" (31.8mm) with optional nozzles



VCT-0384-2698 **\$745⁹⁵**

Medalist® 350 CLASSIC - Heavy Duty Cutting & Welding Outfit

- Cuts up to 3/4" (19.1mm) or up to 6" (152.4mm) with optional tips
- Welds up to 1/8" (3.2mm) or up to 3" (76.2mm) with optional nozzles



Oxygen / Acetylene Hose Reels



ATD-31170 **\$299⁹⁵**

Heavy Duty Retractable Oxy-Acetylene Welding Hose Reel

- 1/4" x 50 ft. twin oxygen/acetylene hoses
- Solid brass fittings and connections with double O-ring seals for leak-free operation
- Heavy-duty spring driven, automatic rewind
- 8-position hose locking mechanism
- Reel can be mounted to ceilings, wall, floors, vehicles, workbenches, etc.



Welding Hammers

TIT-41225 **\$11⁸⁵**

Chipping Hammer

- Use to chip and remove slag from welds
- Coiled spring handle helps absorb shock while chipping



MAY-37002 **\$45⁷⁵**

12 Oz. Welders Chipping Hammer



Surge Protectors



GDL-32-030 **\$172³⁵**
12/24V Antizap Clamp-On Surge Protector

- Protects vehicle electronics during MIG, TIG or stick welding



DTF-DF-601A **\$95⁴⁵**

Surge Protector

- Protects electronic components
- Works on 12 and 24 Volt systems



OTC-3386 **\$202⁹⁵**
12V Antizap® Auto Surge Protector



Welding Clamps & Aids



Quick Holding Magnetic Welding Clamps with On/Off Switch

- High strength magnets hold metal workpieces at 45°, 90°
- Switchable style ensures easy precise adjustment: turn the magnet OFF or at the midpoint position when setting up, turn ON when you're ready to work
- Ideal for round and square tubing, angle, and flat stock

Item #	Angles	Dimensions	Pull Force*	
ECL-QHCSS	45°, 90°	111 x 92 x 29mm	88 lbs	\$108.05
ECL-QHCSL	45°, 90°	152 x 130 x 35mm	165 lbs	\$178.45

* Magnetic force is based on the longest side of magnet with 10mm thick steel.



Inside and Outside Welding Clamps

- Hold and position sheet metal, round pipes, square, angled or flat stock
- Use mounting holes to link two magnets together for use as fixturing elements
- Use hex hole on magnet for breakaway leverage

Item #	Angles	Dimensions	Pull Force	
ECL-IOWCC (Pack of 2)	30°, 60°, 90° 30°, 60°, 90°	75.5 x 52 x 14mm 125 x 85 x 18mm	20 lbs 33 lbs	\$74.55
ECL-IOWCL	30°, 60°, 90°	165 x 110 x 20mm	40 lbs	\$60.95

NOTE: Must be used for tack welding only and removed before completing weld.



GRI-98356 **\$69⁹⁵**
3-Pc Welding "F" Clamps

- 6" x 3"
- 8" x 3"
- 12" x 3"



VCT-1423-1404 **\$280⁶⁵**
Welding Protective Blanket and Equipment Cover, 38" x 24"

- Fiberglass fabric protects equipment during welding, cutting, grinding and other potentially hazardous operations
- Service range up to 1000°F / 538°C
- Resistant to abrasion
- Blanket can be draped over equipment or used as a curtain



Welding Helmets & Gloves



GRI-98122 **\$109⁹⁵**

Eagle Auto-Darkening Solar Welding Helmet

- Variable shades from DIN 9 to 13
- 3.86" x 2.17" viewing area
- Filters protect against UV & IR



HAS-HSW-7030 **\$277¹⁵**

Auto-Pro™ Solar and Battery-Powered Auto-Darkening Welding Helmet

- Large auto-darkening lens: 4.5" x 5.25"
- Comfortable 5-point headgear with sweatband
- Adjustable GRIND/WELD, 9-13 DIN, sensitivity and delay
- Maximum sensitivity, four UV/IR sensors to 3 Amps
- Solar cell and lithium battery power with status LED
- Certified ANSI, CSA, AS/NZS & CE



VCT-1441-0004 **\$144¹⁵**

Lift/Fixed Front Combo Helmet, 4.5" x 5.25", Black

- Streamlined, compact design allows welders to get into tight places
- Meets or Exceeds: ANSI Z87-1, CE and various International Standards



1441-0085



1441-0086



1441-0088

Auto-Darkening Welding Helmets

- Adjustable welding shade levels from 9 to 13
- Four arc sensors for high response
- Sensitivity and delay

Item #	Model	
VCT-1441-0085	Pinstripes	\$227.25
VCT-1441-0086	Piston and Plug	\$227.25
VCT-1441-0088	Skull and Fire	\$227.25

TITAN



45000

41266



41290



41279

Auto-Darkening Solar Welding Helmets

- Variable shades from DIN 9 to 13
- 3.86" x 2.17" viewing area
- Filters protect against UV & IR
- High performance solar cells with built-in batteries as power back-up

Item #	Model	
TIT-45000	Biker Girls	\$163.45
TIT-41290	Gear Head	\$163.45
TIT-41266	Flames	\$163.45
TIT-41279	Skull	\$163.45

TITAN

TIT-41264 **\$5⁹⁵**

Clear Replacement Lenses

- 3.86" x 2.17" viewing area
- Includes:
 - 1 inner lens (4.25" x 2.25") and
 - 1 outer lens (4.5" x 3.5")

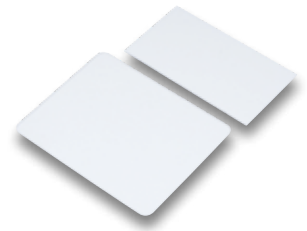

TITAN

TIT-41239 **\$20⁷⁵**

Welding Gloves

- Premium Leather
- Lined



HAS-HSW-9007 **\$27⁴⁵**

Premium TIG/MIG Welding Gloves

- Offers maximum dexterity and protection
- Kevlar-stitched for extra durability



MEASURING & PRECISION INSTRUMENTS

Measuring Tapes

TITAN

Quick-Read Tape Measures

- Tough, impact resistant plastic case
- Hands-free blade lock



Item #	Length x Blade Width	Markings	
TIT-10905	16 ft. x 3/4"	SAE	\$8.15
TIT-10906	25 ft. x 1"	SAE	\$12.05
TIT-10907	25 ft./7.5m x 1"	SAE/Metric	\$12.05
TIT-10908	33 ft. x 1"	SAE	\$16.35

TITAN

TIT-10903 **\$17⁴⁵** 2-Pc Dual Rule Quick-Read Tape Measures Set

- 12 ft. (3.5m) and 25 ft. (7.5m)
- SAE and Metric markings



Lufkin

P1000 Series Hi-Viz® Orange Measuring Tapes

- Power return
- Impact resistant case



Item #	Scale	Blade L x W	
LUF-PHV1035CMEN	SAE/Metric	16 ft. x 3/4" (5 meters x 19mm)	\$23.05
LUF-PHV1048CMEN	SAE/Metric	26 ft. x 1" (8 meters x 25mm)	\$30.75



Measuring Tapes

Item #	Series	Scale	Length	Width	
MLW-48-22-6825	Compact Auto-Lock	SAE	25 ft.	1" (25mm)	\$23.45
MLW-48-22-6625G	Compact	SAE	25 ft.	1" (25mm)	\$43.75
MLW-48-22-9717	STUD™	SAE/Metric	16 ft./5m	1-5/16" (33mm)	\$33.75
MLW-48-22-9726	STUD™	SAE/Metric	26 ft./8m	1-5/16" (33mm)	\$40.55
MLW-48-22-6626G	Compact	SAE/Metric	26 ft./8m	1" (25mm)	\$43.75

DEWALT

Atomic Compact Series Tape Measures

- Integrated finger brake
- Straighter, stronger 13-ft. max reach



Item #	Scale	Blade L x W	
DEW-DWHT38116S	SAE	16 ft. x 1-1/4"	\$18.55
DEW-DWHT38125S	SAE	25 ft. x 1-1/4"	\$21.15
DEW-DWHT38126S	SAE/Metric	26 ft./8m x 1-1/4"	\$21.15
DEW-DWHT38130S	SAE	30 ft. x 1-1/4"	\$29.15

Toughseries™ Lighted Tape Measures

- Built-in LED light
- Double-sided print for vertical & overhead measurements
- Straighter, stronger 17-ft. max. reach
- Up to 3 hours runtime
- Auto-shutoff
- Includes a USB charging cable



Item #	Scale	Blade L x W	
DEW-DWHT35625S	SAE	25 ft. x 1-1/4"	\$44.75
DEW-DWHT35268S	SAE/Metric	26 ft./8m x 1-1/4"	\$44.75

Distance Meters

MLW-48-22-9801 **\$92⁶⁵** 65 Ft. Laser Distance Meter

- Provides measurements from all orientations
- Continuous real-time measurements
- Memory storage for 3 readings
- Accuracy: ±1/8"
- Impact-resistant overmold for protection
- Belt Clip



Straight Edges

CEN-6429 **\$178⁶⁵** 24" Precision Straight Edge



RIDGID **\$27⁰⁵** 2m Fiberglass Folding Metric Rule



MEASURING & PRECISION INSTRUMENTS

Levels

FOW-74-440-600-0 **\$133⁶⁵**

9" Electronic Laser Level

- Embedded magnets
- Reversible reading for inverted use
- Dimensions: 9"L x 1"W x 2-1/4"H



Fowler

MLW-48-22-5210 **\$75⁰⁵**

10" Magnetic Torpedo Level with 360° Locking Vial

- Magnified vial for an accurate reading
- 360° adjustable vial with locking feature
- Heavy duty die cast aluminum frame



Milwaukee

Calipers



Fowler

FOW-72-030-006-1 **\$232⁸⁵**
6"/150mm Inch/Metric Dial Caliper

- Higher quality unit with improved gearing movements
- Range: 0-6"/150mm
- Graduation: 0.001"/0.02mm
- 4-way measurement



Fowler

FOW-74-101-175-0 **\$35²⁵**
6" Poly-Cal® Electronic Caliper

- Range: 0-6"/150mm
- Graduation: 0.0005"/0.01mm/1/64ths"
- Inch/Metric/Fraction • 4-way measurement



Central
STORM

CEN-3C312 **\$197⁹⁵**
12"/300mm Electronic Digital Caliper

- Range: 0-12"/0-300mm
- Inch to Metric conversion
- Measure Inside, Outside, Depth, Step



Fowler

FOW-74-102-006-0 **\$86⁴⁵**
6" AutoCal Electronic Caliper

- Range: 0-6"/150mm
- Graduation: 0.0005"/0.01mm/1/128ths"
- Inch/Metric/Fraction • Floating zero
- 4-way measurement



Central
STORM

CEN-3C301 **\$60⁰⁵**
6"/150mm Digital Dial Caliper

- Range: 0-6"/0-150mm
- Graduations: .0005"/.01mm
- Inch to Metric conversion
- Measure Inside, Outside, Depth, Step



ATD

ATD-8656 **\$65⁹⁵**
6"/150mm Digital Caliper

- Range: 0-6"/0-150mm • Graduation: .001"/.01mm
- Inch to Metric conversion
- 4 Measurements: Inside, Outside, Depth, Step



ATD

ATD-8657 **\$79⁴⁵**
6"/150mm Digital Caliper

- Range: 0-6"/150mm • Graduation: .001"/.01mm or 1/64"
- 4 Measurements: Inside, Outside, Depth, Step



Tobler

TBQ-6426

Electronic Inch/Metric Stainless Steel Calipers

Item #	Range	Grad.	
TBQ-6426	0 - 6"/150mm	0.001"	\$39.45
TBQ-6428	0 - 8"/200mm	0.001"	\$49.95
TBQ-6412	0 - 12"/270mm	0.01"	\$78.55



Fowler

XTRA-VALUE Electronic Caliper Gauges

- Reading: Inch/Metric/Fraction
- Graduation/Accuracy: 0.01"/0.3mm/1/64ths"



74-554-630-0

Item #	Description	Range	
FOW-74-554-630-0	Outside Caliper	0 - 6"/150mm	\$80.55
FOW-74-554-730-0	Inside Caliper	0.5 - 6"/150mm	\$80.55

Micrometers



FOW-72-229-214-0 **\$261⁹⁵**

4-Pc Outside Micrometer Set

- Range: 0-4"
- Graduation: 0.0001"



FOW-74-870-001-0 **\$127²⁵**

Xtra-Value II Electronic Micrometer

- Range: 0-1"/0-25mm
- Resolution: 0.00005"/0.001mm
- Accuracy: ±0.00016"/0.004mm
- Includes ball attachment



CEN-3M114 **\$331⁸⁵**

4-Pc Conventional Micrometer Set

- Range: 0-4"
- Graduation: 0.0001"



FOW-74-880-001-0 **\$166¹⁵**

AutoMic Plus+ Electronic Micrometer

- Corrosive resistant ratchet thimble (anodized aluminum)
- Super large screen
- Range: 0-1"/0-25mm
- Resolution: 0.00005"/0.001mm
- Accuracy: ±0.00015"/0.003mm
- Includes ball attachment



Indicator Sets



FOW-72-585-155-0 **\$120⁵⁵**

Indicator Set with Magnetic Base

- Travel: 1"
- Reading: 0.001"
- Continuous reading: 0-100
- Tolerance markers
- Magnetic V-base can be placed on round surfaces



FOW-72-585-450-0 **\$190⁰⁵**

Indicator Set with Flexible Arm and Magnetic Base

- Travel: 1" • Reading: 0.001"
- Continuous reading: 0-100
- Tolerance markers
- Magnetic V-base can be placed on round surfaces



CEN-3D101 **\$131³⁵**

Dial Indicator Set with Magnetic Base

- Range: 0-1" • Graduations: 0.001"



FOW-72-585-245-0 **\$280⁰⁵**

Indicator Set with Flexible Arm and "Anyform" Magnetic Base

- Travel: 1" • Reading: 0.001"
- Magnetic base with 70 steel segments fit to practically any shape or form



CEN-3D103 **\$178⁵⁵**

Dial Indicator Set with Locking Pliers and Flex-Arm

- Range: 0-1" • Graduations: 0.001"



FOW-72-520-757-0 **\$144⁰⁵**

Economy Disc and Rotor/ Ball Joint Gauge

- Inch/Metric
- Range: 0-1"/25mm
- Graduations: 0.001"/.01mm



CEN-3D107 **\$136⁹⁵**

Indicator Set

- Range: 0-1"
- Graduations: 0.001"
- Extra strong on/off magnetic base
- Fine adjust mechanism



FOW-72-520-767-0 **\$199⁹⁵**

Disc and Rotor/ Ball Joint Gauge

- Dust, water and oil resistant
- X-Proof™ indicator
- Range: 0-1" (0-25mm)
- Graduations: .001" (.01mm)



Bore Gauges



CEN-3D302 **\$293¹⁵**

6" Dial Bore Gauge

- Range: 1.4"-6"
- Graduations: 0.0005"



FOW-72-646-400-0 **\$262⁷⁵**

6" Dial Bore Gauge Set

- Range: 1.4"-6"
- Graduations: 0.0005"

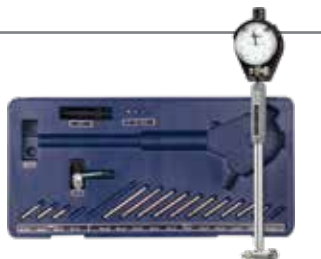

FOW-74-646-401-0 **\$492¹⁵**

6" Electronic Bore Gauge Set

- Inch/Metric
- Range: 1.4"-6"/35mm-150mm
- Graduations: 0.00005"/0.001mm
- Bar graph and numeric digital display
- Preset with recall
- Absolute/Incremental measurement
- Min/Max/TIR



Depth Gauges

CEN-3S116 **\$72⁴⁵**

6-Pc Telescoping Gauge Set

- Range: 5/16" - 6"
- Self-centering gauges check slots, grooves, recesses and cylinders



CEN-3M746 **\$83⁶⁵**

Digital Depth Gauge

- Range: 16"
- Accuracy: 0.0005"
- Inch to Metric conversion



FOW-54-125-777-0 **\$416⁶⁵**

0 - 22" Electronic Depth Gauge

- 0 - 1" travel
- Zero reset at any position
- Relative/absolute measuring
- Resolution: 0.0005"/0.01mm
- Measurement hold feature
- 4" base



FOW-74-225-555-0 **\$81⁶⁵**

0 - 16"/550mm Electronic Depth Gauge

- 0 - 1"/25mm travel
- Spring-loaded
- Measurement hold feature
- Super large display
- Resolution: 0.0005"/0.01mm/1/64th



Drill Gauges



FOW-52-480-005-0 **\$68⁷⁵**

Jobber Drill Gauge

- 1/16" - 1/2"
- 29 holes
- Hardened and ground



IRW-12092 **\$10⁴⁵**

Steel Fractional Drill Bit Gauge

- 1/16" - 1/2" • 29 holes

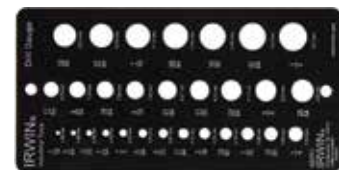

Torque Angle Gauges

LIS-28100 **\$70⁴⁵**

Torque Angle Meter

- Commonly used for tightening head bolts and other bolts where a torque angle is required
- Use with 1/2" drive



OTC-4554 **\$31⁶⁵**

Torque Angle Gauge

- Required when servicing many late model engines that use torque-to-yield fasteners
- Measures angle of rotation
- Has 1/2" male and female square drives



Angle Measuring Devices

FOW-74-422-450-1 **\$123⁸⁵**

Mini-MAG Protractor Magnetic Angle Measuring Device

- Provides instant 360° digital inclination display of any angle
- Embedded magnets with 3.5 lbs pull
- Measuring range: 360° (4 x 90°)
- Hold feature



FOW-74-440-775-1 **\$144¹⁵**

Digi-Pro 12" Electronic Protractor

- Used to make fast and accurate angular measurements
- Embedded 25 lbs pull magnets
- Full, 360° measuring range



CEN-6494A **\$25⁷⁵**

Angle Finder with Magnetic Base

- Measures truck and automotive front ends and drive shaft angle



Brake Bleeders



110V Electric Brake Bleeders

- One man operation
- Easy to use and fill
- Adjustable pressure regulator from 0-50 psi, also ensures constant pressure at all 4 wheels
- Automatic low fluid level shut-off to prevent air bubbles
- SAE-style coupler assures compatibility with existing adapters
- Fluid level indicator
- Adapter tray
- 10-ft. pressure hose



Item #	Tank
CCT-STBBE2.5GAL	2.5 Gallon
CCT-STBBE4.0GAL	4 Gallon



FREE!

Buy #MIT-MV6830 and obtain #MIT-MVA6832 for free: 1.2 L Master Cylinder Clamp-On Auto-Refill Kit.



MIT-MV6830 **\$293¹⁵**

Vacuum Brake & Clutch Bleeder/Evacuator

- Simple operation allows clean, quick bleeding of brake and clutch lines
- 1.8 liter capacity reservoir
- Bleeds up to 1.9 liters of fluid/minute
- Automatic shutoff valve

MIT-MV7135 **\$363⁹⁵**

Vacuum Brake & Clutch Bleeder

- 2.5 L capacity reservoir
- Utilizes compressed "shop-air" for dispensing and extracting
- Isolated flow control valve and pressure/vacuum switch



MIT-MV7840 **\$624⁸⁵**

Pressure Brake & Clutch Bleeder

- 2.5 L capacity reservoir
- Utilizes compressed "shop-air" for dispensing and extracting
- Isolated flow control valve and pressure/vacuum switch
- 7-Pc master cylinder adapter kit



MIT-MV6840 **\$652³⁵**

Professional Hydraulic Brake and Clutch Bleeding System

- 1.2 gallon (5 L) fluid capacity
- Includes 7 master cylinder adapters to connect to most American, Asian and European cars and light trucks



MIT-MV6870 **\$172⁹⁵**

Vacuum Brake and Clutch Bleeder

- 1.3 qt. (1.2 L) fluid reservoir
- Powerful compressed-air-operated venturi that quickly draws out fluid and air from hydraulic brake and clutch system



MIT-MV8000 **\$78⁰⁵**

Automotive Tune-Up and Brake Bleeding Kit

- For performing hundreds of automotive diagnostic and mechanical tests and for one-person brake bleeding



FREE!

Buy #MIT-MV8500 and obtain #MIT-MVA660 for free: Universal Power Steering Adapter, 5/8" to 1-5/8".



MIT-MV8500 **\$152⁵⁵**

Silverline Elite Automotive Kit

- Provides either vacuum or pressure
- Performs engine performance diagnostics, brake bleeding, fluid transfer, evacuation, sampling, windshield repair and more



TIT-51885 **\$56⁸⁵**

1 L Vacuum Brake Fluid Bleeder

- Universal rubber fitting holds securely on brake bleed screw
- Locking trigger and hanging hook
- Working pressure: 71-113 PSI



Brake Bleeders

CTA-7310 **\$660⁵⁵**
12-Pc Brake Bleeder Tank & Master Cylinder Adapter Kit

- Includes:
- #7300: 10 master cylinder adapters + 1 quick coupler
 - #7015: Brake Bleeder 3L Tank



CTA-7310M **\$845⁷⁵**
14-Pc Brake Bleeder Tank & Master Cylinder Adapter Kit

- Includes:
- 12 master cylinder adapters + 1 quick coupler
 - #7015: Brake Bleeder 3L Tank



CTA-1275 **\$912⁴⁵**
12-Pc Brake Bleeder Tank & Pro Series Master Cylinder Adapter Kit

- Includes:
- #7300: 10 all metal construction master cylinder adapters + 1 quick coupler
 - #7015: Brake Bleeder 3L Tank



CTA-3930 **\$734⁶⁵**
11-Pc Pro Series Brake Bleeder Master Cylinder Adapter Set

- All metal construction
- For use with #7015 Pressure Bleeder Tank. Adapts to other brands with the included special quick-coupler.
- Covers the newest applications



CTA-7300 **\$492⁶⁵**
11-Pc Brake Bleeder Master Cylinder Adapter Kit

- For use with #7015 Pressure Bleeder Tank. Adapts to other brands with the included special quick-coupler.
- Will service most makes & models



CCT-BAKIT01 **\$876²⁵**
Global Brake Bleeder Adapter Set

- For Domestic, European and Asian vehicles
- Now includes a Honda Master Cylinder Adapter (#BAHON1)



CAL-24630 **\$123⁰⁵**
Universal Brake Bleeder Adapter

- Universal design fits plastic master cylinders on nearly any application
- Fits 1" to 2.76" O.D.
- Use with M-style or universal quick-connect couplers only



GWR-3795D **\$865²⁵**
4-Gallon Air Pump Brake Bleeder Tank

- Diaphragm-type bleeder for conventional and anti-lock brake systems
- Diaphragm keeps brake fluid and air separated
- For use with DOT 2, 3, 4 and 5 brake fluids only



ATD-5125 **\$322⁶⁵**
1-Gallon Brake Bleeder Tank

- 3/8" I.D. x 10-1/2 ft. hose
- Quick disconnect coupler, shut-off valve and pressure gauge
- Portable tank fills and bleeds both standard and power brakes in a single operation
- Suitable for DOT 3 and DOT 4 brake fluids only



TIT-51995 **\$163⁷⁵**
5-Pc Hydraulic Brake & Clutch Bleeder Wrench Kit

- Fits seven popular sizes: 7mm x 8mm, 9mm x 10mm, 11mm x 12mm, 3/8"



CTA-1945 **\$250²⁵**
8-Pc Brake Bleeder Wrench Kit

- Sizes: 3/8", 7mm-12mm
- Wrenches designed with a sealing ring for a secure seal of the bleeding nut



Double-Ended Brake Bleeder Wrenches

Item #	Screw Size	
LIS-10900	5/16" x 3/8"	\$16.35
LIS-10950	1/4" x 3/8"	\$16.15
LIS-11000	7mm & 9mm / 8mm & 10mm	\$16.35



Brake Service Tools



CTA-7394 **\$191³⁵**
18-Pc Euro Brake Caliper Socket Set

- **7 Point:** 14mm, 22mm
- **10 Point:** 11.5mm, 15mm, 20mm
- **5 Point:** 10mm, 10mm (Male) 12.5mm, 14mm, 19mm
- **6 Point:** 7mm, 7mm (Stubby), 7mm (Deep), 8mm (Stubby), 9mm (Stubby), 9mm (Deep), 11mm (Deep)
- **12 Point:** 14mm Tamper-Proof

CTA-5035 **\$108⁴⁵**

5-Pc VW/Audi/Porsche Brake Caliper Socket Set

- Services the caliper retaining screws • 1/2" square drive
- Includes:
 - #5025 - 7 pt. Small
 - #5027 - 7 pt. Large
 - #5029 - 10 pt. x 11.5mm
 - #5031 - 10 pt. x 15mm
 - #5033 - 10 pt. x 20mm



TBQ-10330 **\$333³⁵**

18-Pc Disc Brake Caliper Tool Kit

- Applicable to a wide variety of 2WD & 4WD vehicles
- Includes 15 adapter discs as well as left-hand & right hand thrust bolt assemblies to work on front or rear brakes



ATD-5165 **\$158¹⁵**

18-Pc Disc Brake Caliper Tool Set

- For use on most domestic & import 2WD & 4WD vehicles
- Use on front or rear brakes



AST-78618 **\$76⁹⁵**

18-Pc Brake Caliper Wind Back Tool Set

- Provides both left-handed and right-handed thrust bolt assemblies
- Works on a wide range of vehicle applications
- Designed for push back and wind back brake pistons



SUN-3930 **\$135⁵⁵**

Master Brake Caliper Tool Set

- Contains caliper adapters that range from 1-3/16" to 2-1/2" as well as adapters specifically designed to service Nissan, Saab and Honda models
- Contains caliper rotation tools with right hand and left hand threads. Caliper rotation tool with left threads is especially useful for late model Ford cars and light trucks.



MTC-43050 **\$304⁸⁵**

Air-Powered Brake Caliper Wind Back Tool Kit

- Pneumatic brake caliper piston compression
- 15 piece press adapter set
- Left or right wind-back operation
- Magnetic base to secure press adapters



MTC-43051 **\$197²⁵**

Air Powered Brake Caliper Wind Back Tool

- Allows right and left-hand rotation



LIS-25200 **\$63⁴⁵**

2 & 3-Pin Adjustable Brake Caliper Tool

- Works on right or left hand rewind calipers
- 2-pin range: 1/2" to 1-1/2" (12.7mm to 38mm)
- 3-pin range: 1" to 1-11/16" (25.4mm to 43mm)

CTA-1458 **\$19¹⁵**

3-Pin Brake Piston Wind Back Adapter

- For use with late model VW, Audi and BMW with electro-mechanical parking brakes (EPB)



AST-7848 **\$59²⁵**

8-Pc Professional Brake Tool Set

Brake Service Tools

LIS-24300 **\$79⁹⁵**
Speedy Brake Pad Spreader

Lisle



LIS-25750 **\$99⁴⁵**
Dual Piston Brake Pad Spreader

LIS-24400 **\$16⁴⁵**
Disc Brake Pad Spreader
 • For installing pads on most domestic and import cars and light trucks

LANG Made in USA

LAN-277 **\$100³⁵**
Small Brake Caliper Press

- Works on small & medium single piston brake calipers found in subcompact to mid-size vehicles
- Size range is 1" to 3"
- Applies pressure in a parallel manner



LAN-279 **\$113⁰⁵**
Brake Caliper Press

- Works on various single, dual & quad piston calipers
- Centrally distributes force to prevent misalignment of pistons
- 360 degree ratchet swing allows access at any angle
- Reversing lever allows for easy change from spreading to retracting

LANG Made in USA



AST-78610 **\$73⁶⁵**
Brake Caliper Spreader Press

- Suitable for 1, 2 and 4 piston calipers
- Features a forward and reverse switch



LIS-44210 **\$35¹⁵**
Universal Emergency Brake Cable Spring Tool

Lisle



9CL-30581 **\$44¹⁵**
Drum Brake Hold-Down Spring Pliers

- Works on drum brake hold-down spring washers
- Offset design allows easy access to spring washers located behind wheel hubs (Toyota and Chrysler)
- Adjustable jaw, up to 60mm



9CIRCLE

GTW GEARWRENCH

GWR-2774D **\$22⁵⁵**
Universal Brake Shoe Retaining Spring Tool

- Fits 5/8" to 11/16" and 11/16" to 7/8" diameter retaining washers



Lisle

LIS-45100 **\$18²⁵**
Brake Spring Tool

- Designed for import car brake return springs



Lisle

LIS-48400 **\$18⁷⁵**
Import Car Brake Clip Tool
 • Designed for import cars with brake shoe hold-down clips



MUELLER KUMPE

MUK-460 300 **\$67⁹⁵**
Universal Multi-Cleaner

- Works great on brakes, exhausts, etc...
- Includes:
 - (1) Handle
 - (1) 40 x 110mm brush
 - (1) 50 x 110mm brush



9CIRCLE

NEW

9CL-30460 **\$44⁹⁵**
10.6" Long Four-Sided Brake Caliper File

- Coarse teeth for removing rust or coarse residue
- Fine teeth for detailed cleaning or final polishing



MUELLER KUMPE

Brake Caliper Files

- Scraper on the face end for removal of coarse residue

Item #	Application	
MUK-460 200	Domestic & Euro Cars	\$46.85
MUK-460 202	Asian Cars	\$55.05



LIS-13410 **\$13⁴⁵**
Brake Caliper Brush

- Removes brake dust, rust and other debris

Lisle



TOOL AID
 PROFESSIONAL AUTOMOTIVE TOOLS

SGT-17380 **\$13²⁵**
Disc Brake Caliper Brush

- For removal of brake dust and dirt from caliper shaft



BRAKE SERVICE

Brake Service Tools

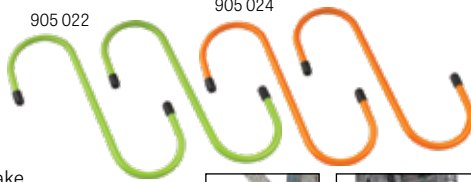

Uni-Hook-Kit

- Ideal for hanging brake calipers, cords, hoses, etc.
- #905 024 is non-bendable for hanging larger and heavier objects

Item #	Description	
MUK-905 022	Bendable	\$17.55
MUK-905 024	Solid	\$17.55

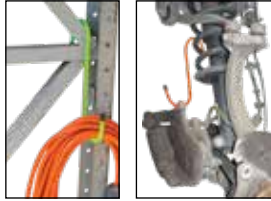

LIS-48020 **\$13⁶⁵**



2-Pc Brake Caliper Hanger Set

- Hangs the disc brake caliper out of the way during service while keeping tension off the brake line



TITAN

TIT-51600 **\$7⁵⁵**

Brake Caliper Hanger Set

- 1/4" heavy-duty steel
- Perfect for a variety of hanging applications as well as automotive applications such as brakes, wheel bearings, axle shafts and suspension

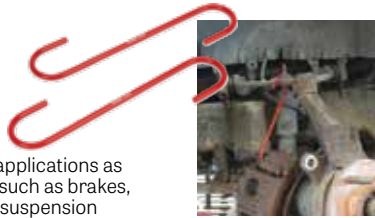

Brake Fluid Testers

Brake Fluid Testers

- Determines quality of brake fluid
- Measures moisture from 0%-4%
- 1.5V AAA battery included

Item #	Application	
OTC-4598-DOT3	DOT 3	\$66.05
OTC-4598-DOT4	DOT 4	\$68.45



Brake Rotor Hones



Flex-Hone® for Rotors

- Produces the ideal surface finish on automotive and motorcycle disc brake rotors, automotive fly wheels and clutch plates

Item #	Grit	
BRM-RMFH120Z25	Medium - 120	\$85.55
BRM-RMFH60Z25	Coarse - 60	\$85.55

Brake Lathe Bits

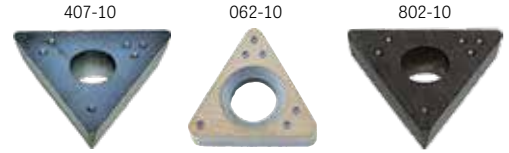

Carbide Bits for Bench and On-The-Car Lathes

- All Shark bits are guaranteed to perform as well as any OEM bits
- Sold in packs of 10 bits

Item #	Fits Lathe Brands	Cutting Edges	
SHA-062-10	Ammco; FMC/John Bean/Barrett/Snap-On; Hofmann; Rels	6 (12 by cross-indexing)	\$30.05
SHA-407-10	FMC/John Bean/Barrett/Snap-On; Hofmann/RJ WEST; Pro-Cut/Hofmann	3 (6 by cross-indexing)	\$70.85
SHA-802-10	Kwik-Way/Snap-On; Rels	3 (6 by cross-indexing)	\$81.25

Truck Brake Service Tools



KEN-80000

Bendix® ADB22X™ Air Disc Brake Tool Kit

- Kit provides specialized tools for the replacement of Bendix® air disc brake tappet and boot assemblies, tappet inner seals, and guide pins and boots
- Compatible with Bendix's new ADB22X-LT for trailer air disc brakes

LOC-891 **\$81⁴⁵**

Bendix/Knorr-Bremse Air Disc Brake Pad Retainer Tool

- Provides safer and easier way to remove pad retainer
- Works with left and right side calipers
- Designed to work with or without caliper shield



LOC-890 **\$94⁰⁵**

Truck Brake Spring Tool

- Easily connects rear drum brake return springs
- Adjusts to 3 sizes

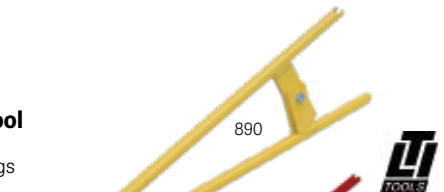

LOC-895 **\$94⁰⁵**

Eaton Truck Brake Spring Tool

- Universal fit to install all Eaton air brake shoe anchor springs



Truck Brake Service Tools

LIS-39770 **\$50⁷⁵**

Brake Spring Fork

- Easily removes and replaces the S-Cam return spring



Lisle

LIS-49000 **\$31⁴⁵**

Truck Brake Cage Bolt Socket

- 5" long x 3/4" socket • 1/2" drive



Lisle



LIS-40030 **\$50⁷⁵**

18" Long S-Cam Brake Spring Bar

- Replaces brake shoes on heavy-duty tractor and trailer S-cam brakes



Lisle

LIS-29120 **\$15⁴⁵**

11 Point Truck Brake Caliper Adjustment Socket

- For air disc brake caliper adjustment
- Works on Bendix ADB 22X, ADB 225, SN6, SN7, SK7 air disc brake calipers



Lisle

OTC-5081 **\$141⁷⁵**

S-Cam Air Brake Spring Removal Tool

- Safely replace brake shoes on heavy-duty tractors and trailers



OTC

OTC-5052 **\$90⁹⁵**

Brake Slack Checker

- Enables you to quickly check the brake adjustment on Class 7 and 8 trucks and trailers having S-cam brakes
- Works on manual or automatic slack adjusters



OTC

LANG Made in USA



8569

Automatic Slack Adjuster Wrenches

- For brake service and slack adjuster installation on heavy-duty trucks

Item #	Hex	Application	
LAN-7578	7/16"	Haldex	\$52.85
LAN-8569	9/16"	Bendix®	\$77.55

LANG Made in USA



LAN-4651 **\$99⁴⁵**

Automatic Slack Adjuster Release Tool & Wrench for Rockwell® & Meritor® Systems

- The set contains a fork-end tool to release the tensioner button, and a 5/16" double square offset reversible wrench

FREE!
While quantities last

Buy #LAN-4651 and obtain #LAN-7578 for free: 7/16" Automatic Slack Adjuster Wrench for Haldex.



TIGER TOOL Made in Canada

TGR-16002 **\$432⁵⁵**

Brake Anchor Pin Press, 10-Ton Capacity

- Safely and easily remove brake anchor pins and bushings on virtually all 16-1/2" S-Cam trailer and tractor "Q" brake systems in minutes
- Includes a bushing removal adapter



Cal-Years 1983

CAL-70100 **\$278⁹⁵**

10-Ton Capacity Brake Anchor Pin & Bushing Press

- Remove brake anchor pins and bushings on 16-1/2" S-cam brakes and other quick-change setups on semi-trucks and trailers
- For use with a 1/2" drive impact



NEW

TIT-85512 **\$48⁰⁵**

Meritor® Brake Slack Adjuster Release Tool and Ratchet Wrench

- Speed up installation and service on Meritor® brake slack adjusters
- 5/16" double square ratchet with an angled head
- Fork-end tool to release the tensioner button



TITAN

OTC-5038 **\$631⁰⁵**

Brake Anchor Pin and Bushing Service Set

- Includes everything needed for removal and replacement
- Replaces the pins and bushings on 16-1/2" S-cam trailer and tractor "Q" brake systems without removing the bearing hub assembly

OTC



Brake Pad, Drum & Rotor Gauges

OTC-6596 **\$48¹⁵**

Quick Reference Brake Pad Gauge

- **Green** = OK (8mm+)
- **Yellow** = Replace soon (3mm to 8mm)
- **Red** = Replace immediately (0mm to 3mm)



OTC

SGT-65300 **\$35⁹⁵**

Metric In-Line Brake Pad Gauge

- In-line style allows use without removing the wheels on many vehicles
- Can measure both internal and external brake pads
- Calibrated for 6mm backing plate



TOOL AID
PROFESSIONAL AUTOMOTIVE TOOLS

Brake Pad, Drum & Rotor Gauges



Lisle



LIS-81850 **\$28⁵⁵**
9-Pc Combination Brake Lining Thickness Gauge Set
 • Metric sizes: 2mm – 12mm
 • SAE sizes: .0787 – .4724

LIS-83400 **\$31⁷⁵**
9-Pc Truck Brake Lining Thickness Gauge Set
 • Metric sizes: 6mm – 22mm
 • SAE sizes: .2362" – .8661"

GW GEARWRENCH

GWR-3962 **\$30¹⁵**
8-Pc Brake Lining Thickness Gauge
 • All steel construction
 • Green: 8mm (.315"), 10mm (.393"), 12mm (.472")
 • Yellow: 4mm (.157"), 5mm (.196"), 6mm (.236")
 • Red: 2mm (.078"), 3mm (.118")

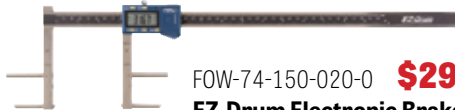

Fowler

FOW-74-150-020-0 **\$297⁴⁵**
EZ-Drum Electronic Brake Drum Gauge
 • Inch/Metric/Fraction • Range: 4"-20"/100-500mm
 • Resolution 0.0005"/0.01mm/1/64ths"
 • 4" drum preset
 • Zero set • Preset depth at 1" and 1.5"
 • Can be used to check some disc measurements

FOW-74-150-050-0 **\$351¹⁵**
EZ-Drum Reach Electronic Brake Drum Gauge
 • Measures most heavy-duty drums while the wheels are still mounted on the vehicle
 • Inch/Metric/Fraction
 • Range: 4"-18.7"/100-475mm (internal measurements)
 • Resolution: 0.0005"/0.01mm/1/64ths"
 • 4" setting master and 4" drum preset (101.60mm) • Floating zero



Fowler

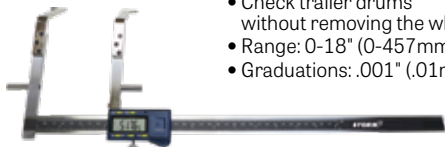

Central
STORM

CEN-3B631 **\$454²⁵**
Electronic Digital "Wheels-On" Drum Gauge
 • Check trailer drums without removing the wheel
 • Range: 0-18" (0-457mm)
 • Graduations: .001" (.01mm)



ATD-8658 **\$392⁸⁵**
Electronic Digital Automotive and Heavy-Duty Drum Gauge
 • Range: 4"-20.65" (150mm-515mm)
 • Graduations: .001"/.01mm

ATD-8660A **\$144⁷⁵**
Electronic Inch/Metric Rotor Gauge

- Depth rod for measuring pad wear
- Pointed anvils and 3.5" long arms to inspect rotors before turning or replacing them
- Range: 0 to 4" (0 to 100mm)
- Graduations: 0.001"



ATD



Fowler

FOW-74-150-005-0 **\$146⁶⁵**
Rotocal® Reach Electronic Rotor Gauge
 • Measures the rotor without removing the wheel
 • Inch/Metric/Fraction • Range: 0-3.25"/0-82.5mm
 • Resolution: 0.0005"/0.01mm/1/64ths"



Central
STORM

CEN-3M336 **\$206⁸⁵**
Electronic Digital "Wheels-On" Rotor Gauge
 • Measures the rotor without removing the wheel
 • Range: 0-3.2"/0-80mm • Graduations: .001" (.01mm)
 • Interchangeable pointed/flat anvil

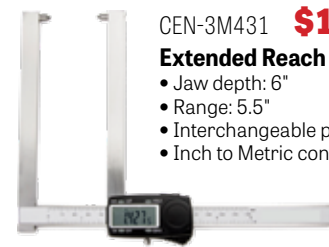

Central
STORM

CEN-3M431 **\$129³⁵**
Extended Reach Digital Rotor Gauge
 • Jaw depth: 6"
 • Range: 5.5"
 • Interchangeable pointed/flat anvil
 • Inch to Metric conversion



Fowler

Rotocal® Electronic Rotor Gauges
 • Inch/Metric/Fraction
 • Range: 5.5"/140mm
 • Resolution: 0.0005"/0.01mm/1/64ths"

Item #	Jaw Depth	
FOW-74-150-004-0	3.5"	\$118.35
FOW-74-150-002-0	6"	\$118.35

PBT-70960 **\$236⁵⁵**

Seal Tool Kit

- Install & remove all car, light truck, and SUV crankshaft & camshaft seals without damage
- Suits seals from 21.5mm – 64mm



AST-78825 **\$218⁸⁵**

Master Front Wheel Drive Bearing Adapter Kit

- Sizes: 2.18" to 3.48"

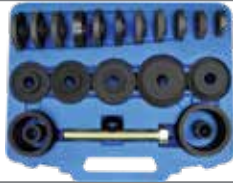

LIS-12980 **\$155⁵⁵**

Bearing Race and Seal Driver Set

- Sizes: 1.565" to 3.180"



TBQ-17244 **\$44³⁵**

10-Pc Bearing Race & Seal Driver Set

- Sizes: 1.555" (39.5mm) to 3.189" (81mm)



LIS-12800 **\$242⁶⁵**

Master Pneumatic Bearing Race & Seal Driver Set

- Set contains 11 drivers to fit automobiles and trucks up to 1 ton
- Sizes: 1.565" to 4.625"



LIS-61900 **\$413⁵⁵**

Heavy Duty Bearing Race & Seal Driver Set

- Driver sizes: 3-43/64", 4-7/8", 4-13/16", 5-1/2", 5-25/32", and 6"



LIS-61850 **\$441⁷⁵**

5-Pc Truck Hub Seal Installer Kit

- Fits the most popular sizes for Class 7 and Class 8 over the road trucks and trailers and some medium duty trucks
- Sizes: 4-13/16" to 6"-5/16"



TBQ-12370 **\$204⁰⁵**

7-Pc Truck Hub Seal Installer Kit

- Fits the most popular sizes for Class 7 & 8 over the road trucks and trailers as well as some medium duty trucks
- Includes (5) drivers: 4-13/16" to 6"-5/16"



CTA-1222 **\$1082⁶⁵**

Ford/Volvo Wheel Bearing Kit

- Services up to 82mm diameter wheel bearings on newer Gen 2 type wheel bearings
- **Applications:** 2006+ Ford Focus, Fusion, Land Rover Freelander 2, Volvo S80, V70, XC60 & XC70



ATD-8625 **\$196¹⁵**

Front Wheel Drive Bearing Adapter Kit

- Sizes: 2.18" to 3.48"



ATD-8622 **\$59⁹⁵**

10-Pc Bearing Race and Seal Driver Set

- (9) adapter sizes: 1.565", 1.750", 1.965", 2.325", 2.470", 2.555", 2.830", 2.995", 3.180"



MUK-432 600 **\$440³⁵**

Universal Press Disc Kit

- Universal tool set for pressing in and out wheel bearings, bushings, shaft seals etc.
- Disc sizes: 60mm-85mm



Universal Press and Pull Sleeve Kits for Bushings & Bearings

- For extracting and installing all types of bushings, bearings and seals



MUK-609 400 **\$841¹⁵**

Universal Press & Pull Kit

- 20 sleeves with outer diameters of 1-3/4" to 3-1/8" (44mm-82mm)
- 4 spindles
- 4 discs



MUK-609 400/460 **\$1270¹⁵**

Universal Press & Pull Combination Kit

- 20 sleeves with outer diameters of 1-3/4" to 3-1/8" (44mm-82mm)
- 4 spindles
- 4 discs
- X-Large C-clamp specifically made for use with impact tools



MAY-62015 **\$163⁶⁵**

4-Pc Pro Bearing Race Punch Set

- 7/16" x 6", 1/2" x 10", 9/16" x 14", 5/8" x 20"



BEARING, BUSHING & SEAL SERVICE

OTC-7180 **\$565²⁵**

Universal Bearing Cup Installer

- Adjustable tool to install wheel-bearing cups in a wide range of heavy-duty axles
- Works on axles from 11,000 to 50,000 lb. capacity
- Adjusts to fit 3-5/8" to 6-1/2" O.D. bearing cups



OTC

OTC-4410 **\$157⁴⁵**

33-Pc Master Bushing Driver Set

- Enables you to remove and install bushings ranging from 10mm to 42mm in diameter and 3/8" to 1-3/8" in diameter



OTC-4505 **\$97⁶⁵**

19-Pc Fractional Bushing Driver Set

- Enables you to remove and install bushings ranging from 3/8" to 1-3/8" in diameter



TIGER TOOL

TGR-15000 **\$2887⁴⁵**

Pin & Bushing Starter Kit

- This system reduces shop time by as much as 70%
- Service both rubber-isolated and threaded pins and bushings while the suspension remains on the vehicle
- 20 tons of pulling power for efficient pin removal and installation
- Requires a 10,000 psi pump and at least one adapter to operate
- All of the adapter kits are available separately



OTC Made in Canada

TGR-15030 **\$1049⁹⁵**

Pin & Bushing Adapter for Freightliner Airliner & Peterbilt Low Air Leaf

- For use with the #15000 Pin & Bushing Starter Kit
- Easily remove and install the Freightliner Airliner and Peterbilt Low Air Leaf rubber isolated pin and bushing while the suspension remains on the vehicle
- 20 tons of pulling power



TGR-15040 **\$1574⁹⁵**

Pin & Bushing Adapter

- For use with the #15000 Pin & Bushing Starter Kit or can alternately be used with #17202 20-Ton Hydraulic Cylinder and a 10,000 PSI Hydraulic Pump
- Easily remove and install the Hendrickson Intraax Tri-Functional bushing while the suspension remains on the trailer

Works on:

- Automater TRB5912
- Dayton 334-1576
- Euclid E-10729A
- Flagg HT245
- Gaff 13628
- Hendrickson S-24691



TIGER TOOL

TGR-15032 **\$493⁴⁵**

Pin & Bushing Adapter, 4" Long

- For use with the #15000 Pin & Bushing Starter Kit
- I.D.: 13/16"; O.D.: 2-1/4"

Works on:

- Dayton RB-211, RB-233
- Flagg RB211, RB233
- Freightliner 680-322-01-05, 680-322-01-50
- Gaff 11066
- Mack 43RU297M



LIS-29090 **\$116⁹⁵**

2-Pc Truck Anchor Pin Bushing Driver

- Pneumatic bushing driver set removes and installs truck and trailer 1-3/8" anchor pin bushings and stuck anchor pins
- Also removes truck leaf spring bushings



Lisle

15-Ton Capacity Freightliner Rear Suspension Bushing Removal and Installation Tools

- Removes and installs single-wrapped FAS II Airliner Freightliner rear suspension bushings
- Handles Neway AD Series Truck and Tractor suspension bushings



OTC



OTC-4244

Freightliner Rear Suspension Bushing Tool

OTC-4245

Freightliner Rear Suspension Bushing Tool Master Kit

- Includes #OTC-2510A air/hydraulic pump: 10,000 psi

OTC-4261

Hendrickson Airtex NXT Front Suspension Bushing Tool

- Kit comes with hydraulic cylinder and foot pump



OTC-4263

Suspension Bushing Tool

- Removes and replaces suspension bushings
- Comes with a 25-ton capacity hydraulic cylinder and press plate for hands free operation



OTC-4255 **\$1262⁷⁵**

Hendrickson Airtex NXT Bushing Adapter Kit

- Kit is used in conjunction with the #OTC-4263 Suspension Bushing Tool to remove and replace the leaf spring bushings on Hendrickson Airtex NXT front suspensions found on Freightliner Cascadia vehicles



Tire Changers

COATS

HEN-8560995001



RC-55 Rim Clamp® Tire Changer, Electric Model

- Wheels handled: alloy and steel for car and light truck
- RC Robo-Arm®, built-in bead sealing jets, conveniently placed foot pedals
- Electric drive system: 1 HP motor, 115 V, 60 Hz, 15 A
- **Rim diameter:** 6" - 24" external – up to 28" with adapters (sold separately)
- **Max. tire diameter:** 50" • **Max. rim width:** 10.5"
- **Warranty:** 1 year parts, 6 months labor
- Air drive system available
- Additional accessories available upon request



Made in USA



Transportation Not Included (All Models)



Installation & Training Included (All Models)



MAXX 70 Rim/Clamp® Tire Changer

- For high volume tire dealers or general repair shops
- Wider, more robust chassis with more power, more features and improved speed and reliability
- **Wheels handled:** alloy and steel for car and light/medium truck
- Features a polymer Duckhead and Robo Arm to make changing tires a breeze
- Hand operated bead loosener
- Dual nozzle bead sealer
- No-index tabletop saves time
- **Rim diameter:** 6" - 24" external – up to 30" with optional clamps
- **Max. tire diameter:** 50"
- **Max. rim width:** 16"
- **Warranty:** 3 years parts, 6 months labor
- Footprint: 74" W x 86" H x 44" D
- Additional accessories available upon request



Made in USA



Installation & Training Included



HEN-8183061 **\$54⁵⁵**

Nylon Duckhead® Mount/Demount Tool

- Eliminates any metal-on-metal contact with the wheel
- Compatible with all X-Series and RC Series tire changers



HEN-8184432 **\$99³⁵**

Plastic High Spoke Duckhead® Mount/Demount Tool

- Designed for high-spoke wheels, lifting the bead above the spokes
- Compatible with all X-Series and RC Series tire changers



HEN-8183710 **\$66⁸⁵**

Paste Tire Lube, Bucket - 7.7 lbs



Item #	Motor	
HEN-800MAXX70	110V	
HEN-800MAXX70220	220V 2HP, 60Hz	
HEN-800MAXX70A	Air 4HP	

Wheel Balancers



HEN-800885



Model 885 Wheel Balancer

- Direct Tape-A-Weight™ placement
- Balancing modes: 5
- Behind spoke mode: Yes
- Wheel diameter range: 10" - 30"
- Wheel width range: 2" - 16"
- Max. tire diameter: up to 38"
- Max. tire weight: 130 lbs
- Interface: LED matrix with soft touch keys
- Automatic data entry: Distance/Diameter/Width
- Auto brake: Yes
- Auto lock: Yes
- Auto start: on hood close
- Electrical requirements: 110V, 1ph, 50/60 Hz, 3A
- Warranty: 1 year parts, 6 months labor



Installation & Training Included



HEN-8113277C **\$586⁷⁵**

Light Truck Front Cone Kit - 40mm I.D.

- Double sided cone & metal backing plate
- Range: 4.80" - 6.80"



COATS

WHEEL & TIRE MAINTENANCE

Inflators & Gauges



MIC-W1991 **\$115⁹⁵**
**Dial Type
 Tire Inflation Gauge**
 • Scale: 10-174 psi (0.7 to 12 Bar)
 • 5 ft. (1.5m) hose



LEG-AL2000FZ **\$72²⁵**
Tire Inflator
 • 20 to 170 psi
 • Straight-on chuck with 12" air hose
 • Heavy-duty gauge
 • Indicator bar is calibrated in 2 psi increments from 20 to 100 psi



SGT-65100 **\$77⁸⁵**
Tire Inflator with Pop Up Gauge
 • Scale: 10-120 psi in 2 psi increments
 • Dual head chuck on 12" hose



SGT-65110 **\$115⁷⁵**
Tire Inflator with Dial Gauge
 • Scale: 0-120 psi, 0-830 kPa
 • 6" dual head chuck
 • 13" long hose with 360° swivel



SGT-65120 **\$114⁹⁵**
Tire Inflator Gauge with Magnifying Window Lens
 • Scale: 10 - 120 psi in 2 lb. increments
 • Three function lever: inflates tire, reads pressure and releases air
 • 360° degree swivel between 15" air hose and 6" dual head chuck



SGT-65130 **\$120⁷⁵**
Truck Tire Inflator with Dial Gauge
 • Scale: 0 - 160 psi, 0 - 1100 kPa
 • 14" dual head chuck
 • 13" long hose with 360° swivel



AST-3083 **\$55⁴⁵**
2.5" Dial Tire Inflator with Locking & Dual Chucks
 • Scale: 0-160 psi
 • Inflate, deflate and measure tire pressure
 • Includes 15" swivel hose, dual chuck, locking chuck, and "M" & "T" style air fittings

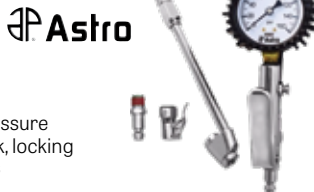

MIL-S-576A **\$192⁵⁵** **MILTON**
Pro Analog Pistol Grip Inflator Gauge
 • Scale: 0-160 psi, 0-11 Bar
 • 15" hose, 6" dual foot chuck with 360° swivel
 • 2.75" diameter liquid-filled gauge for optimal accuracy and pressure spike prevention



LEG-AL2025FZ-2 **\$271³⁵** **Legacy FLEXZILLA**
Tire Inflator Kit with Two Flexzilla® Hoses
 • Scale: 10-170 psi / 0-11.7 Bar
 • Trigger actuated deflate function
 • Includes 3 ft. and 15 ft. Flexzilla® air hose extensions
 • Quick-connect coupler and plug



PA Astro
 AST-3081 **\$96⁸⁵**
3-1/8" Dial Gauge Tire Inflator
 • Scale: 0-174 psi / 0-12 Bar
 • Inflate, deflate, measure tire pressure
 • Works with CO2 (carbon dioxide)
 • 21" hose



AST-3018 **\$173⁸⁵** **PA Astro**
3.5" Digital Tire Inflator
 • Scale: 3-175 psi
 • Inflate and deflate
 • 21" stainless braided hose
 • Displays: PSI, BAR, kGF, kPa
 • Works with nitrogen and CO2 systems



ATD-8750 **\$123⁰⁵** **ATD**
Digital Tire Inflator Gauge
 • Scale: 0-255 psi / 0-1,800 kPa / 0-18 kg/cm² / 0-18 Bar
 • Inflates/deflates
 • Auto-on when pressure detected and auto-off after 15 seconds
 • Rubber boot protects gauge against impact
 • Gauge swivels 360° for easy reading
 • Uses (2) AAA batteries (included)
 • 23-1/2" hose with lock on air chuck



MARTINS INDUSTRIES
 MRI-MH-30 **\$104⁶⁵**
Flate Mate Digital Tire Inflator
 • Scale: 174 psi / 12 bar / 1,200 kPa / 12.2 kg/cm²
 • Inflate and deflate
 • 6 ft. hose



Inflators & Gauges



MRI-MHA-100 **\$333⁸⁵**

Flatematic Automatic Tire Inflator

- Inflate or deflate your tires automatically
- Scale: 174 psi / 12 bar / 1,200 kPa / 12 kg/cm²
- 6 ft. hose
- Rechargeable li-ion battery inflates up to 500 times on one single charge
- Preset your 2 most used pressures
- **Over-pressure setting (OPS), Nitrogen compatible**



MRI-MW-64HP **\$598¹⁵**

Flatematic High-Pressure Automatic Tire Inflator

- Scale: 0-232 psi
- Wall-mounted unit with 25 ft. hose
- Displays: PSI, Bar, kPa, kg/cm²
- Nitrogen purge cycles



MRI-MW-60-4WAY **\$629⁴⁵**

Flatematic Automatic Tire Inflator with 4 Outlets

- Scale: 0-145 psi
- Wall-mounted unit with (4) 8-ft. hoses
- Displays: PSI, Bar, kPa, kg/cm²
- Nitrogen purge cycles



AME-24867 **\$141⁹⁵**

Accu-Flate XL Digital Tire Inflator

- Scale: 0-174 psi
- Inflate, deflate, measure tire pressure
- Hose length: 6 ft
- Accuracy: ± 2 psi
- Displays: PSI, Bar, kPa



TIT-19357 **\$154¹⁵**

3" Digital Tire Inflator

- Scale: 0-174 psi
- Air bleed function
- 22" long hose with locking air chuck
- Displays: PSI, Bar, kPa, kgf



MIL-S-580EKIT **\$550⁰⁵**

Precision Digital Tire Inflator & Pressure Gauge

- Includes 4 interchangeable air chucks, M-Style® plug and valve cap holder
- Scale: 0-160 psi
- Display automatically adjusts for left or right-handed use or vertical "portrait" mode
- Displays: PSI, kPa, Bar, and kg/cm²



MLW-2475-21XC **\$277⁹⁵**

12V Compact Tire Inflator Kit

- 0 - 120 psi
- Inflates car, light truck, and compact equipment tires
- Hose length: 26"
- (4) Attachments: ball inflation needle, inflator nozzle, Presta chuck, Schrader chuck
- (1) M12™ CP4.0 battery
- (1) Charger



MLW-2848-20 **\$247⁹⁵**

M18™ 18V Tire Inflator (Bare Tool)

- 0 - 150 psi
- Displays: PSI, kPa, Bar
- (4) Memory presets
- Auto pressure check; Auto shut off
- Hose length: 36"
- (4) Attachments: inflation needle, inflator nozzle, Presta chuck, Schrader chuck



DEW-DCC020IB **\$171³⁵**

20V MAX* Corded/Cordless Air Inflator

- Scale: 3-160 psi
- High-pressure inflation with auto shutoff
- 29" high-pressure hose
- Onboard accessory storage
- 13.75 ft. 12V DC power cord
- High-pressure tapered nozzle
- Presta valve adapte
- Inflator needle



KEN-35110 **\$13⁰⁵**

18" Long Tire Kicker

- Use for checking tire air pressure on large trucks



LEG-HGH2-FZ **\$107²⁵**

Truck Tire Inflator Kit

- Uses a truck's on-board air supply to inflate tires in remote situations
- 3/8" x 50 ft. Flexzilla® air hose
- Glad-hand attachment
- 30° Dual air chuck



WHEEL & TIRE MAINTENANCE

Inflators & Gauges

MILTON



Tire Pressure Gages

Item #	Chuck Head	PSI	Applications	
Pencil Type Pressure Gages				
MIL-S-921	Single	5-50 psi	Passenger Car	\$13.25
MIL-S-928	Single	5-50 psi	Tractor Air/Water Filled Tires	\$18.75
MIL-S-925	Single	20-120 psi	Truck • RV • Bicycle	\$13.75
MIL-S-927	Dual	20-120 psi	Truck	\$20.05
Service Gages				
MIL-S-976	Dual	10-160 psi	Heavy-Duty	\$44.25
MIL-S-986	Straight Foot Dual Head	10-160 psi	Heavy-Duty	\$52.15
Dial Type Tire Gage				
MIL-S-934	Single	0-120 psi	Car & Truck	\$74.25

Model S-934 Includes a Tire Tread Depth Gauge

MILTON



Dual Head Straight Foot Air Chucks

- 1/4" FNPT
- Max. 150 psi
- For inner duals

Item #	Length	
MIL-S-693	6"	\$24.25
MIL-S-693-12	12"	\$36.75



MIL-S-698 **\$18²⁵**
Single Head Air Chuck with Grip

- 1/4" FNPT
- Max. 150 psi
- Closed/sealing type chuck
- Not for use with inflator gage



MIL-S-699 **\$5⁶⁵**
Single Head Air Chuck

Tire & Tube Test Tanks

LIS-19822 **\$129⁴⁵**
Tire/Tube Test Tank

- 31" x 12" x 12"

Lisle



Tread Depth Gauges

AUTEL MaxiTPMS

TBE100

TBE200

MaxiTPMS – Laser-Enabled Tire Tread Depth & Brake Disc Wear Analysis Tools

- Compatible with passenger, off-roads, and heavy-duty vehicles
- Expanded features when used with Autel's ITS600
- No need to remove the wheel during measurement
- Full tread measurement / Quick Check

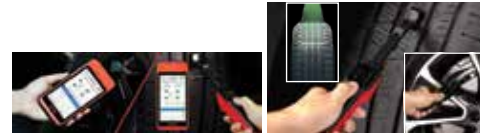

Item #	AUL-TBE100	AUL-TBE200
Touchscreen	0.95"	1.65"
Camera	• 1 Megapixel 4cm Macro Camera	• 1 Megapixel 4cm Macro Camera • 8 Megapixel 10cm Zoom Camera
Li-Ion Battery	1,300 mAh	3,000 mAh
Vibration Reminder	■	■
Measurement Accuracy	0.1mm	0.1mm
Real-Time Measurement Data on Touchscreen	■	■
Measurement Data Curve Display		■
Uneven Wear Analysis	When used with #ITS600	■
Replacement & Maintenance Suggestions: tire/disc replacement, tire rotation, four tire alignment	When used with #ITS600	■
Test Detail for Single Tire Tread/Brake Disc		■
Comprehensive Test Report with TPMS	When used with #ITS600	When used with #ITS600
Scan DOT		■
Tire Expiration Notice		■
Tire Recall Lookup		■
Take Photos of Tire Wear and Damage		■
	\$482.15	\$616.65

SGT-65140 **\$9¹⁵**

Tire Tread Depth Gauge

- Sliding gauge measures 0 - 1" in 1/32" increments, and 0 - 25mm in 1mm increments



TOOL AID
PROFESSIONAL AUTOMOTIVE TOOLS

FOW-74-225-500-0 **\$28⁶⁵**

X-Tread® Tire Tread Thickness Gauge

- Inch/Metric/Fraction
- Range: 1"/25mm
- Resolution: 0.0005"/0.01mm/1/64ths
- 2.1" base, 0.095" diameter rod



Fowler

Tire Repair

AST-7445 **\$37⁷⁵**
45-Pc Tire Repair Tool Kit

- T-handle insert tool
- T-handle spiral probe cement tool
- 40-Pc 4" string
- (2) Allen wrenches • Lubricant



KT-340

BLACK JACK
Tire Repair



KT-335

T-Bone Permanent Tire Repair Kits

- T-handle insert tool and spiral probe
- Screwdriver and valve core tool
- Allen wrench • Lubricant

Item #	Application	Repair Strings	
BJK-KT-340	Passenger Car	(40) 4" Strings: 20 small & 20 large diam.	\$86.95
BJK-KT-335	Truck	(35) 6" Strings 20 small & 15 large diam.	\$86.95



8635

ATD



8630

Tire Repair Tool Kits

- T-handle insert tool
- T-handle spiral probe reamer
- (2) Allen wrenches • Lubricant

Item #	Kit	Application	Repair Strings	
ATD-8630	45-Pc	Passenger Car	(40) 4" Strings (#ATD-86301)	\$33.65
ATD-8635	35-Pc	Truck	(30) 7.5" Strings (#ATD-86303)	\$35.65

AME-26148 **\$45⁵⁵**
Super Liquid Tire Sealant, 1 Gallon

- Seals punctures of up to 1/4"
- Lubricates rims and tire for quick and easy removal
- Eliminates rust on rims
- Water based for easy clean-out
- Will not freeze
- Tires run cooler



Shown in use



AME-73200 
Automatic Truck Tire Spreader with Air Lift

- Air lift allows operator to repair without lifting
- Air regulator/lubricator
- Work lamp
- Input: 110VAC
- Air pressure: 100 PSI
- Max tire width: 13.75"
- Max. tire diameter: 47"
- Max. tire weight: 330 lbs



AME-73080 **\$360⁷⁵**
Floor Mount Tire Spreader

- Multiple height and width adjustments
- For use with passenger and light truck tires: 13"-20"
- Heavy duty rollers cradle the tire
- Weight 63 lbs



Valve & TPMS Service Tools



KEN-29999 **\$20⁸⁵**
11-3/4" ValveCapper® Pro 4-in-1 Cap and Core Remover/Installer

- Makes it easier to check the inside dual tire
- No more moving your rig to position valve stems just to get to the caps
- Holds onto caps and valve cores for removing and replacing
- Longer valve cap grip works on flow-through, double seal valve caps
- For use on metal and plastic valve caps



Ken-Tool®

LIS-15190 **\$16⁴⁵**
Valve Core Tool

- For removing and installing standard valve cores



Lisle

MIL-S-444 **\$7⁶⁵**
Valve Core Tool

- For removal & insertion of valve cores
- One end for standard bore, one end for large bore valves



MILTON

MIL-S-449 **\$20⁹⁵**
Valve Insertion Tool

- For the installation or removal of "snap-in" type tubeless tire valves



MILTON

MUK-437 001 **\$17⁵⁵**
Valve Core Tool

- For removal & insertion of valve cores
- Holds on to the valve core after removing



LIS-19860 **\$29¹⁵**
Tire Deflator Set for TPMS Valve Stems

- Quickly evacuates air from tires without removing the valve core
- Tools are marked so tires can be returned to their original position on the vehicle so TPMS will not need to be reset

Lisle



WHEEL & TIRE MAINTENANCE

Torque Limiting Extensions & Sockets

GW GEARWRENCH

GWR-89650 **\$133²⁵**
5-Pc 1/2" Drive 8" Long Torque Limiting Impact Extension Set
 • 65 ft-lb (90 Nm)
 • 80 ft-lb (110 Nm)
 • 100 ft-lb (135 Nm)
 • 120 ft-lb (160 Nm)
 • 140 ft-lb (190 Nm)
 • Includes blow molded case



PA Astro

AST-78810 **\$172⁹⁵**
10-Pc Torque Limiting Extension Set
 Includes 1/2" drive, 8" long extensions:
 • 65ft/lb (90Nm) • 110ft/lb (150Nm)
 • 75ft/lb (100Nm) • 120ft/lb (160Nm)
 • 80ft/lb (110Nm) • 130ft/lb (175Nm)
 • 90ft/lb (120Nm) • 140ft/lb (190Nm)
 • 100ft/lb (135Nm) • 150ft/lb (200Nm)



SUN-2450 **\$174⁵⁵**
5-Pc 1/2" Drive Torque Limiting Extension Set
 • 65 ft-lb • 120 ft-lb
 • 80 ft-lb • 140 ft-lb
 • 100 ft-lb

SUNEX[®] TOOLS



ATD-4380 **\$327¹⁵**
10-Pc 1/2" Drive Wheel Torque Extension Set
 • 65 ft-lb (88 Nm) ATD-43751
 • 70 ft-lb (95 Nm) ATD-43756
 • 80 ft-lb (110 Nm) ATD-43752
 • 90 ft-lb (120 Nm) ATD-43757
 • 100 ft-lb (135 Nm) ATD-43753
 • 110 ft-lb (150 Nm) ATD-43758
 • 120 ft-lb (160 Nm) ATD-43754
 • 130 ft-lb (175 Nm) ATD-43759
 • 140 ft-lb (190 Nm) ATD-43755
 • 150 ft-lb (200 Nm) ATD-43760

ATD



ATD

ATD-4375 **\$189³⁵**
5-Pc 1/2" Drive Wheel Torque Extension Set
 • 65 ft-lb (88 Nm) ATD-43751
 • 80 ft-lb (110 Nm) ATD-43752
 • 100 ft-lb (135 Nm) ATD-43753
 • 120 ft-lb (160 Nm) ATD-43754
 • 140 ft-lb (190 Nm) ATD-43755



LT TOOLS

LOC-1460 **\$245⁰⁵**
5-Pc 1/2" Drive Wheel Torque Extension Kit

- Included extensions:
 - 1400F: 65 ft-lb, 90 Nm
 - 1400E: 80 ft-lb, 110 Nm
 - 1400C: 100 ft-lb, 135 Nm
 - 1400I: 120 ft-lb, 160 Nm
 - 1400Q: 140 ft-lb, 190 Nm
- Yearly updated colour wall chart (#LT-1400WC)



LT TOOLS

LOC-1470 **\$350⁶⁵**
7-Pc 1/2" Drive Wheel Torque Extension Kit

- Included extensions:
 - 1400F: 65 ft-lb, 90 Nm
 - 1400E: 80 ft-lb, 110 Nm
 - 1400C: 100 ft-lb, 135 Nm
 - 1400K: 110 ft-lb, 150 Nm
 - 1400I: 120 ft-lb, 160 Nm
 - 1400Q: 140 ft-lb, 190 Nm
 - 1400BB: 160 ft-lb, 215 Nm
- Yearly updated colour wall chart (#LT-1400WC)



1600 Series – Heavy-Duty 3/4" and 1" Drive Truck Wheel Torque Extensions

Item #	Drive	Ft-Lb	
LOC-1600O	3/4"	175 ft-lb	\$120.75
LOC-1600N	3/4"	250 ft-lb	\$120.75
LOC-1600M	3/4"	475 ft-lb	\$120.75
LOC-1600R	1"	250 ft-lb	\$120.75
LOC-1600B	1"	400 ft-lb	\$120.75
LOC-1600P	1"	475 ft-lb	\$120.75
LOC-1600Y	1"	550 ft-lb	\$120.75

LT TOOLS



LT TOOLS

LOC-1500-LWC(2023) **\$83⁰⁵**
Wheel Torque Socket Laminated Wall Chart – 28" x 28"

- Includes 31 colour coded socket specs and thousands of vehicles they work on



Torque Limiting Extensions & Sockets

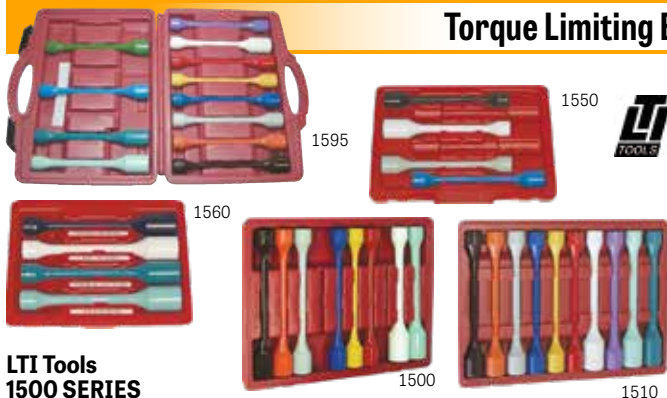

LTI Tools 1500 SERIES 1/2" Drive Wheel Torque Socket Sets

- Kits include a colour wall chart
- Refer to LTI 1500 Series torque sockets chart for size and torque info

Item #	Kit	1500 SERIES Sockets Included:	
LOC-1550	4-Piece	A, C, E, I	\$205.25
LOC-1560	4-Piece	BB, I, Q, Y	\$205.25
LOC-1500	8-Piece	A, B, C, E, F, G, I, Q	\$404.65
LOC-1510	10-Piece	A, B, BB, C, E, F, G, I, K, Q	\$493.95
LOC-1595	12-Piece	A, B, BB, C, DD, E, F, G, I, K, Q, TT	\$605.55

SUN-2880 **\$508⁹⁵** **SUNEX[®]** **10-Pc 1/2" Drive**

Torque Limiting Socket Set

- 17mm: 55 ft-lb and 80 ft-lb • 21mm: 80 ft-lb
- 19mm (3/4"): 65 ft-lb, 80 ft-lb, 100 ft-lb
- 22mm (7/8"): 120 ft-lb, 140 ft-lb
- 13/16": 100 ft-lb • 15/16": 140 ft-lb



KEN-30176 **\$297⁰⁵** **Ken-Tool[®]** **6-Pc 1/2" Drive Torque Master[®]**

Torque Limiting Socket Set

- 19mm (3/4"): 65 ft-lb – Yellow
- 19mm (3/4"): 80 ft-lb – Blue
- 19mm (3/4"): 100 ft-lb – Gray
- 21mm: 60 ft-lb – Black
- 13/16": 100 ft-lb – Brown
- 7/8": 120 ft-lb – White



KEN-30190 **\$556⁴⁵** **12-Pc 1/2" Drive Torque Master[®] Torque Limiting Socket Set**

- 17mm: 45 ft-lb – Dark Green
- 17mm: 80 ft-lb – Red
- 19mm: 90 ft-lb – Gold
- 19mm (3/4"): 65 ft-lb – Yellow
- 19mm (3/4"): 80 ft-lb – Blue
- 19mm (3/4"): 100 ft-lb – Gray
- 21mm: 60 ft-lb – Black
- 21mm: 80 ft-lb – Orange
- 13/16": 100 ft-lb – Brown
- 7/8": 100 ft-lb – Navy Blue
- 7/8": 120 ft-lb – White
- 7/8": 140 ft-lb – Aqua



KEN-30175 **\$216⁴⁵** **4-Pc 1/2" Drive Torque Master[®]**

- 19mm (3/4"): 100 ft-lb – Gray
- 21mm: 150 ft-lb – Turquoise
- 13/16": 100 ft-lb – Brown
- 7/8": 140 ft-lb – Aqua



1500 Series 1/2" Drive Torque Sockets

- Will torque wheel nuts to the correct torque the first time, every time, on most makes and models of Foreign & Domestic cars, light trucks, SUV's and vans

Item #	Colour	Size	Ft-Lb	Nm	
LOC-1500A	BROWN	13/16"	100 ft-lb	135 Nm	\$52.75
LOC-1500AA	LEMON GREEN	22mm	80 ft-lb	110 Nm	\$52.75
LOC-1500B	ORANGE	21mm	80 ft-lb	110 Nm	\$52.75
LOC-1500BB	TURQUOISE	21mm	150 ft-lb	200 Nm	\$52.75
LOC-1500C	GRAY	3/4"/19mm	100 ft-lb	135 Nm	\$52.75
LOC-1500CC	PINK	17mm	90 ft-lb	120 Nm	\$52.75
LOC-1500D	BLACK	21mm	60 ft-lb	80 Nm	\$52.75
LOC-1500DD	SKY BLUE	21mm	100 ft-lb	135 Nm	\$52.75
LOC-1500E	BLUE	3/4"/19mm	80 ft-lb	110 Nm	\$52.75
LOC-1500F	YELLOW	3/4"/19mm	65 ft-lb	90 Nm	\$52.75
LOC-1500G	RED	17mm	80 ft-lb	110 Nm	\$52.75
LOC-1500GG	BEIGE	1-1/16"	80 ft-lb	110 Nm	\$52.75
LOC-1500HH	LIGHT ORANGE	1-1/16"	100 ft-lb	135 Nm	\$52.75
LOC-1500I	WHITE	7/8"	120 ft-lb	160 Nm	\$52.75
LOC-1500J	TAN	1"	140 ft-lb	190 Nm	\$52.75
LOC-1500K	PURPLE	17mm	110 ft-lb	150 Nm	\$52.75
LOC-1500L	APPLE GREEN	1"	170 ft-lb	230 Nm	\$52.75
LOC-1500LL	BUBBLE GUM	22mm	175 ft-lb	235 Nm	\$52.75
LOC-1500NN	GOLD	3/4"/19mm	90 ft-lb	120 Nm	\$52.75
LOC-1500Q	AQUA	7/8"	140 ft-lb	190 Nm	\$52.75
LOC-1500S	LIGHT BLUE	3/4"/19mm	55 ft-lb	75 Nm	\$52.75
LOC-1500SS	SILVER	21mm	110 ft-lb	150 Nm	\$52.75
LOC-1500TT	LIME GREEN	15/16"	135 ft-lb	175 Nm	\$52.75
LOC-1500V	MAROON	1-1/16"	140 ft-lb	190 Nm	\$52.75
LOC-1500XX	VANILLA	13/16"	160 ft-lb	220 Nm	\$52.75
LOC-1500Y	NAVY BLUE	7/8"	100 ft-lb	135 Nm	\$52.75

WHEEL & TIRE MAINTENANCE

Axle Nut/Locknut Tools



Made in USA

9852



9850



OTC-9850 **\$1404¹⁵**

21-Pc Truck Wheel Bearing Locknut Sockets Display Board

◆ See open stock chart for this Display Board's contents

OTC-9852 **\$1009⁸⁵**

12-Pc Truck Wheel Bearing Locknut Sockets Display Board

● See open stock chart for this Display Board's contents



Made in USA

1290

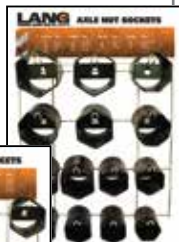

1291



LAN-1291 **\$1273²⁵**

22-Pc Axle Nut Sockets Display

✦ See open stock chart for this Display Board's contents

LAN-1290 **\$856⁶⁵**

14-Pc Axle Nut Sockets Display

■ See open stock chart for this Display Board's contents

Open Stock

Axle Nut/Wheel Bearing Locknut Sockets

Socket Size	Pts.	OTC Item #	Included in OTC #9850 or #9852	OTC Price	LANG Item #	Included in LANG #1291 or #1290	LANG Price
2-3/32"	6	OTC-1901	◆	\$52.25	LAN-1201	✦	\$52.85
54mm (2-1/8")	6				LAN-1229	✦	\$49.75
2-1/4"	6	OTC-1920	◆	\$52.25	LAN-1220	✦ ■	\$54.85
2-3/8"	6	OTC-1902	◆	\$52.25	LAN-1202	✦	\$56.65
2-3/8"	6	OTC-1936*	◆	\$52.25	LAN-1236*		\$56.55
2-3/8"	8	OTC-1903		\$52.25	LAN-1203		\$56.45
2-1/2"	6	OTC-1921	◆ ●	\$52.25	LAN-1221	✦ ■	\$55.15
2-9/16"	6	OTC-1904	◆ ●	\$52.25	LAN-1204	✦ ■	\$54.25
2-9/16"	6	OTC-1928*	◆ ●	\$52.25	LAN-1228*	✦ ■	\$53.85
2-9/16"	8	OTC-1905		\$52.25	LAN-1205		\$59.65
2-5/8"	6	OTC-1922	◆ ●	\$52.25	LAN-1222	✦ ■	\$52.25
2-3/4"	6	OTC-1923	◆ ●	\$52.25	LAN-1223	✦ ■	\$73.05
2-3/4"	6				LAN-1245*	✦	\$50.05
2-3/4"	8	OTC-1937		\$52.25	LAN-1237		\$82.75
2-7/8"	6	OTC-1932	◆ ●	\$52.25	LAN-1232	✦	\$63.45
2-7/8"	8	OTC-1933		\$52.25	LAN-1233		\$60.75
3"	6	OTC-1906	◆	\$52.25	LAN-1206	✦ ■	\$54.35
3"	8	OTC-1907		\$52.25	LAN-1207	✦	\$59.25
3-1/8"	6	OTC-1934	◆	\$52.25	LAN-1234		\$43.25
3-1/8"	8	OTC-1935		\$52.25	LAN-1235		\$43.05
3-1/4"	6	OTC-1908	◆ ●	\$49.35	LAN-1208	✦ ■	\$65.85
3-1/4"	8	OTC-1909	●	\$49.35	LAN-1209	✦ ■	\$66.15
3-3/8"	8	OTC-1924		\$52.25	LAN-1230		\$75.95
3-1/2"	6	OTC-1910	◆ ●	\$49.65	LAN-1210	✦ ■	\$61.15
3-1/2"	8	OTC-1911		\$59.15	LAN-1211		\$61.05
3-3/4"	8	OTC-1925		\$59.15	LAN-1225	✦ ■	\$72.25
3-3/4"	6	OTC-1926	◆	\$52.95	LAN-1231		\$73.55
3-13/16"	8	OTC-1927		\$59.15	LAN-1227	✦ ■	\$67.95
3-7/8"	6	OTC-1912	◆	\$59.15	LAN-1212	✦	\$59.15
3-7/8"	8	OTC-1913	●	\$49.85	LAN-1213	✦	\$58.95
4"	6	OTC-1914	◆ ●	\$52.65	LAN-1214	✦ ■	\$65.25
4-1/8"	6	OTC-1915	◆ ●	\$56.65	LAN-1215	✦ ■	\$69.45
4-1/8"	8	OTC-1940		\$59.15	LAN-1240		\$72.75
4-3/8"	6	OTC-1916	◆	\$59.15	LAN-1216		\$70.55
4-3/8"	8	OTC-1917		\$68.75	LAN-1217		\$73.35
4-1/2"	8	OTC-1938		\$68.75	LAN-1250		\$77.35
4-13/16"	8	OTC-1941		\$56.15	LAN-1241		\$82.35
4-7/8"	6	OTC-1918	◆	\$55.95	LAN-1218		\$81.75
4-7/8"	8	OTC-1919		\$64.95	LAN-1219		\$85.65
5-1/4"	6	OTC-1939	◆	\$93.65	LAN-1239		\$58.95

* Fits special "rounded" hex nut found on Dana axles of some Ford trucks.

General Service Tools



LIS-19852 **\$22³⁵**

Truck & Trailer Wheel Pan

- Catches oil from wheel hubs after removing cap
- The pan fits rims with 13-3/4" ID and larger



Lug Nut, Lug Bolt & Wheel Lock Tools



OTC-5047 **\$96¹⁵**
Lug Nut Cap Remover



LIS-51330 **\$62²⁵**
Adjustable Chrome Lug Nut Cap Remover

Access Tools



AET-EO **\$128⁵⁵**
Easy Off Twist Socket Set for Damaged or Locked Lug Nuts

- Removes damaged or locked lug nuts without a key
- 5 socket sizes fit virtually all vehicles: 17mm, 19mm, 21mm, 23mm, 26mm



CTA-4218 **\$31⁸⁵**
1/2" Drive Mercedes Lug Bolt Impact Socket

- 17mm x 6-point "Flower Design"
- Services 2009+ lug bolts



LOC-4200A **\$55⁴⁵**
Dual Sided 6-Flute Twist Socket Damaged Lug Nut Remover

- 3/4" (19mm), 13/16" (21mm)



LOC-4000 **\$165⁰⁵**
Deluxe Hubcap & Wheel Lock Removal Kit

- Works on GM, Ford, and Chrysler wire wheel hubcap locks on 1978-1997 vehicles
- Works on factory and most after market mag wheel locking nut locks
- Includes #LT4200A Dual Sided Twist Socket Lug Nut Remover



STEELMAN^{pro}

STE-78537 **\$162⁸⁵**
16-Piece Locking Lug Nut Master Key Set

- Includes lug keys for a wide variety of security lug nut styles currently on the market



ATD-3065 **\$220⁵⁵**
16-Piece Locking Lug Nut Master Key Set

- Specifically designed to remove locking lug nuts on nearly every aftermarket wheels



AP Astro

AST-7402 **\$74⁸⁵**
2-Pc 1/2" Drive Double End Damaged Wheel Lock & Lug Nut Removal Twist Socket Set

- 3/4", 13/16", 7/8" and 15/16"



AP Astro

AST-7404 **\$62⁹⁵**
4-Pc Damaged Lug Nut Socket Set with Spinning Protective Sleeves

- 17mm, 19mm (3/4"), 21mm (3/16"), 22mm



SUNEX[®] TOOLS

SUN-2849 **\$174⁹⁵**
9-Pc 1/2" Drive Extra Thin Wall Wheel Protector Impact Socket Set

- 17mm to 21mm, 3/4" to 1-1/16"



AME-67300 **\$167³⁵**
Nut Buddy - Manual Wheel Nut Remover

- Loosens the most stubborn wheel nuts • Gear ratio: 58:1
- Use on commercial or agricultural wheels
- Rated output torque: 2,950 ft-lb • (2) sockets included: 1-1/2" (38mm) & 1-5/16" (33mm) - not impact rated



Lug Nut, Lug Bolt & Wheel Lock Tools



CTA-4001 **\$82⁹⁵**
5-Pc 1/2" Drive Emergency Lug Nut Remover Impact Socket Set

- Removes stripped lug nuts or lug nuts with missing keys
- 3/4", 13/16", 15/16", 1", 1-1/8"



1463



7307

5700



7301



Damaged Lug Nut Socket Sets

Item #	Description	Size Range/Content	
CTA-5700	6-Piece Socket Set, Twist End & Hex End	17mm, 19mm, 21mm, 7/8", 13/16"	\$255.55
CTA-1463	5-Piece Hex Flip Socket Set	18.5 x 19.5mm, 19 x 21mm, 21 x 21.5mm, 22 x 22.5mm, 1/2" drive extension	\$96.95
CTA-7307	7-Piece Hex Flip Socket Set	17 x 17.5mm, 18.5 x 19.5mm, 19 x 21mm, 21 x 21.5mm, 22 x 22.5mm, 27 x 27.5mm, 1/2" drive extension	\$153.15
CTA-7301	1-Pc Hex Flip Socket	17mm x 17.5mm	\$22.95



CTA-5016 **\$348⁴⁵**
Porsche 911 Center Lock Nut Remover/Installer Socket

- Works on Carrera 997 and 991 models
- Max. torque: 500 ft-lb (use a torque wrench or torque multiplier for proper use)
- Comparable to Factory Tool #99136106900



LIS-13050 **\$82⁵⁵**
4-Pc Flip Socket Set for Standard and Damaged Lug Nuts

- Includes: 18.5mm x 19.5mm, 21mm x 21.5mm, 22mm x 22.5mm, punch for flip socket



CAL-96120 **\$56⁷⁵**
4-Pc 1/2" Drive 6 Point Metric Half-Size Impact Flip Socket Set for Damaged Lug Nut

- Increased width to accommodate damaged and swollen capped lug nuts
- Sizes: 17.5mm, 18.5mm, 19.5mm, 20.5mm, 21.5mm and 22.5mm
- Includes a 3" impact extension



71017L

71019L

71021L

71022L



Torque Multiplying Lug Nut Impact Sockets with Hollow Drum Design

- Hollow drum design increases the torque output of 1/2" impact wrenches more than flywheel or weighted socket designs



Item #	Size	
AST-71017L	17mm	\$46.85
AST-71019L	19mm (3/4")	\$46.85
AST-71021L	21mm (13/16") Thin Wall	\$48.75
AST-71022L	22mm (7/8") Thin Wall	\$48.75



CTA-5415 **\$114⁸⁵**
Loose Wheel Nut Indicator Removal Tool

- Easily removes stubborn lug nut indicators found on many heavy-duty fleet vehicles
- These indicators are used as a safety measure to easily determine if a lug nut has loosened over time
- Simply squeeze the handles to remove indicators before service



Wheel Stud Service Tools

TIGER TOOL

TGR-10618 **\$2309⁹⁵**

Wheel Stud Service Kit for Commercial Hydraulic Disks & Drums

- Generates over 10 tons of pressing power
- Applications commonly found on class 6-8 transportation trucks and equipment (Kenworth, Peterbilt, Freightliner, Mack, Volvo, etc.)
- Requires 10,000 PSI hydraulic pump



OTC

OTC-4295 **\$629¹⁵**

Wheel Stud Remover/Installer Kit

- Covers all sizes of studs
- No need to remove hub from vehicle
- Can be powered with an impact wrench, no hydraulic power source required



TIT-16023 **\$34⁴⁵**

Stud Extractor

- Fits 1/4" to 1/2" (6 - 12mm) studs
- Impact gun compatible



LIS-22800 **\$46⁹⁵**

Wheel Stud Installer

- Easily installs new wheel studs on almost all automotive and light-duty truck wheels



AST ASSENMACHER SPECIALTY TOOLS

203

Stud Remover and Installer Sets



Item #	Description	Price
ASM-201	4-Pc - 6, 8, 10, 12mm	\$97.75
ASM-201-7	5-Pc - 6, 7, 8, 10, 12mm	\$129.85
ASM-202	5-Pc - 1/4", 5/16", 3/8", 7/12", 1/2"	\$127.35
ASM-203	7-Pc - 1/4", 5/16", 3/8", 7/12", 1/2", 9/16", 5/8"	\$185.15

LAN-802 **\$161³⁵**

LANG TOOLS

12-Pc Wheel Stud Installer Kit

- For installing button head wheel studs
- For most domestic and foreign cars, light trucks and SUVs
- Includes installers, washer, spacer and corresponding rethreader dies



TOOL AID PROFESSIONAL AUTOMOTIVE TOOLS

NEW

SGT-65180 **\$220⁶⁵**

10-Pc Wheel Stud Pin Hanger Set

- Includes 2 each of:
M12 x 1.25, M12 x 1.5,
M14 x 1.25, M14 x 1.5, M16 x 1.5



Lisle

LIS-14150 **\$110⁶⁵**

8-Pc Wheel Stud Pilot Pin Master Set

- Easily remove and install wheels on vehicles with lug bolts
- Pilot pins allow you to hang the wheel without having to balance the wheel on the small lip of the hub
- Threaded pins in sizes:
(2) 12mm x 1.25; (2) 12mm x 1.5;
(2) 14mm x 1.25; (2) 14mm x 1.5



AccessTools
"The undisputed leader in specialty tools"

AET-WB6 **\$59⁰⁵**

6-Pc Wheel Hangers / Wheel Guides

- Holds wheel in place while working on European vehicles without studs
- Sizes included: 14 x 1.5 (black), 14 x 1.25 (blue), 12 x 1.5 (red)



9CIRCLE

96054



96055

2-Pc Wheel Stud Alignment Guide Sets

Item #	Male Threads	Applications	Price
9CL-96053	M12 x 1.50	Audi, Alfa Romeo, BMW, Mercedes, Mini, Porsche, Vauxhall, Volvo and VW	\$22.05
9CL-96054	M14 x 1.50	Audi, BMW, Citroen, Chrysler, Ferrari, Fiat, Ford, GM, Hyundai, Land Rover, Lamborghini, Mercedes, Opel, Peugeot, Porsche, Renault, Rover, Saab, Seat, Skoda, Vauxhall, VW	\$23.75
9CL-96055	M12 x 1.25	<ul style="list-style-type: none"> • Mini Cooper: 2007-2014 • BMW: 2007: X5; 2008: X5, X6 2009: 750, X5, X6 2010: 750, 760, X5, X6 2011: 528, 535, 550, 740, 750, B7, X5, X6 2012-2013: 325, 335, 528, 535, 550, 740, 750, B7, M5, X5, X6 	\$23.75
9CL-96061	M16 x 1.50	Dodge/Ram ProMaster 2014-2020	\$26.55

Hub & Stud Resurfacing Tools



MUK-433 502/M **\$66⁷⁵**

Wheel Hub Grinder

– Type 1, 60mm Internal

- Special grinder cleans wheel and hub contact surfaces
- Includes (1) 6.3" (160mm) disc



MUK-433 501 **\$107⁷⁵**

3-Pc Replacement Discs for #433 502/M



MUK-433 500 **\$106⁶⁵**

Wheel Hub Grinder

– Type 1, 75mm Internal

- For cleaning the wheel centering device and the attachment face between the wheel and the hub
- Max. speed: 500 rpm



MUK-433 507 **\$106⁶⁵**

Inner Rim Cleaner

- To be used only on the inside of an aluminum rim with an enlarged diameter of 3" (75mm)



MUK-282 260/KIT **\$133⁵⁵**

7-Piece Conical Eraser Kit for Rims

- Removes wheel weights adhesive
- 60mm D. x 26mm H.
- Includes adapter for drill chuck



Stud Cleaners



Item #	Description	
CPT-8940169794	M24 x 37L	\$69.15
CPT-8940169927	M20 x 60L	\$101.15
CPT-8940169928	M22 x 60L	\$101.15
CPT-8940169929	M24 x 60L	\$101.15
CPT-8940169795	M30 x 60L	\$101.15

Hub & Stud Cleaning Discs

- **Black:** general purpose; **Purple:** extra fast
- Box of 10 discs

Item #	Size	Colour	
GLI-53018	1.5" x 5/8"	Black	\$21.35
GLI-56018	1.5" x 5/8"	Purple	\$38.05
GLI-53029	2" x 5/8"	Black	\$22.35
GLI-56029	2" x 5/8"	Purple	\$42.45



ESC-50170 **\$80⁸⁵**

Stud Kleen™ – ALL-IN-ONE Impact Driven Hub/Stud/Wheel Cleaner

- Removes rust, corrosion, and other debris that build up on tire rims, wheel studs, and brake drums with ease
- Longest lasting abrasive pad can clean up to 800 wheels
- Designed to be used on automotive/light trucks



AME-37330 **\$27⁷⁵**

Hub Buddy XL Impact-Rated Lug/Disc Surface Cleaner

- Removes rust, corrosion and other build-up from wheel studs, drums and tire rims
- Includes: 1 Hub Buddy XL attachment and 1 cleaning disc



AME-37335 **\$39³⁵**

6-Pc 2" Cleaning Discs for Model #37330 Hub Buddy XL



AME-37350 **\$106⁵⁵**

Hub Bro – Impact Wheel Hub Cleaner

- 6.3" (160mm) large diameter for cleaning wheel mounting surface
- Ideal for European lug bolt hub cleaning
- 1/2" drive impact rated



3MM-7546 **\$55⁰⁵**

Scotch-Brite™ Roloc™ Brake Hub Cleaning Discs

- Extra coarse
- 1-1/2" x 5/8" center hole
- Box of 10 discs



OTC-8342 **\$72⁹⁵**

Brake Hub Resurfacing Kit

- Kit includes holder and five sanding discs
- Quickly sands rust off lug studs and rotors on the hub assembly
- For most domestic and import vehicles with either front or rear disc brakes
- 10-pack replacement sanding pads: #OTC-552948



CAL-16 **\$108⁰⁵**

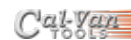

Quick Change Wheel Stud Cleaner Kit

- Comes with a 1/2" drive adapter, and 6 brushes
- Brush sizes include: 12mm (7/16"), 13mm (1/2"), 14mm (9/16"), 16mm (5/8"), and 22mm (1/18")



Wheel Weight Tools



TBQ-6658 **\$32⁶⁵**

Wheel Weight Tool

- Installs, removes, trims and tightens all types of clip-on wheel weights



GWR-3358 **\$57¹⁵**

Wheel Weight Tool

- Tool installs, removes, trims and tightens all types of clip-on wheel weights without marring



ESC-50144 **\$31⁷⁵**

Adhesive Wheel Weight Removal Tool

- For use on multiple sizes of adhesive wheel weights
- Built-in cutter



AME-51220 **\$18⁶⁵**

Heavy Duty Wheel Weight Pliers for Passenger Cars

- Installs, trims and removes all types of wheel weights



Wheel Alignment

EZR-EZLINE **\$1078¹⁵**

E-Z Line® Laser Alignment Tool Kit

- For heavy trucks and all types of trailers
 - Fast, precise axle & wheel alignment
- Kit includes:
- 4 magnetic self-centering lasers
 - 32 ft./10m measuring tape
 - 2 magnetic 5th wheel pin adapters



EZR-EZLINEB1SW



E-Z Line® Complete Laser Alignment Tool

- For 18 wheelers, RV's, commercial vehicles and trailers
- Works with 95% of vehicles 2.5 tons and higher
- Precise axle & wheel alignment • Can align a fully loaded vehicle
- Aligns drop and tag axles
- Multipurpose measurement capabilities

LIS-68130 **\$60⁹⁵**

Wheel Weight Tool

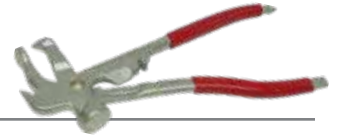

AST-9507 **\$34⁸⁵**

7-in-1 Wheel Weight Hammer Pliers



- One tool removes valve stems and adhesive, cuts, modifies, removes and installs wheel weights

MUK-282 240 **\$133⁵⁵**

Sticky Wheel Weight Removal Pliers



- Removes adhesive wheel weights without damaging the aluminum rims

MUK-282 230 **\$17⁵⁵**

Adhesive Wheel Weight Remover Blade



- Can also be used to remove trim



GAI-GTF-01 **\$131⁶⁵**

GT Force 2-In-1 Wheel Weight Removal and Application Tool

- Save time, save your fingers, lose the hammer!
- This double ended tool has one magnetic end for application and another hook end for removal

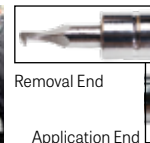

Application End

Heavy-Duty Wheel Service Tools

AME-61020 **\$7³⁵**

10-Hole Truck Wheel Guard

- Composite separator plate to be placed between the hub or drum and the wheel, and/or between two wheels in dual applications
- Provides protection for aluminum or steel wheels against corrosion and excessive wear
- 285.75mm hub-piloted
- Studs: 22mm
- Alcoa model: O11000
- Accuride model: 5903
- Sold per unit



1" Drive Budd Wheel Sockets

Item #	Size	
OTC-1948A	33mm Hex	\$82.65
OTC-1947A	41mm Hex	\$82.65
OTC-1949A	1-1/2" Hex	\$82.65



WHEEL & TIRE MAINTENANCE

Inflation Cages

MARTINS
INDUSTRIES  Made in Canada

Tire Inflation Safety Cages

- Heavy gauge all-steel cages protect the safety of workers, equipment and facilities
- Powder coated UV resistant paint
- Cages meet/exceed OSHA requirements for inflation at 130 psi
- 2 year warranty



Item #	Bars	Max. Tire Size	Length	Width	Height	Weight
MRI-MIC-2	2	48" OD X 13" W	21-1/2"	16-3/4"	51"	69 lbs
MRI-MIC-2WB <i>Wide Base</i>	2	48" OD X 21" W	29"	16-3/4"	52"	78 lbs
MRI-MIC-3	3	47" OD X 19" W	26-1/4"	22-1/4"	57-5/16"	108 lbs
MRI-MIC-4	4	47" OD X 19" W	26-1/4"	31-5/8"	57-5/16"	147 lbs
MRI-MIC-5	5	47" OD X 19" W	26-1/4"	41"	57-5/16"	182 lbs



MRI-MIC-ROLLER **\$174⁵⁵**

Portable Roller Kit for Tire Inflation Cage

- Easily roll your tire/wheel assembly in an inflation safety cage to place valve in proper position
- For use with passenger car & SUV tires, truck & bus super single tires
- 450 lb capacity
- 15" x 15" x 2"
- 100% compatible with MARTINS MIC-3, MIC-4, MIC-5 and MIC-OTR tire inflation safety cages (sold separately)

Tire Racks

MARTINS
INDUSTRIES  Made in Canada



Tire Shelving Racks

- For passenger car and SUV tires
- Shelves are adjustable in 1" increments
- These redesigned models are not compatible to be attached back-to-back with older models #MTS-92, MTS-924 or MTS-925

Item #	MRI-MTSR-3	MRI-MTSR-4	MRI-MTSR-5
Shelves	3	4	5
Dimensions	L: 84-3/4" W: 16-3/8" H: 85-5/8"	L: 84-3/4" W: 16-3/8" H: 117-1/4"	L: 84-3/4" W: 16-3/8" H: 150-1/8"
Max. Tire Cap.	≈ 24 Tires	≈ 32 Tires	≈ 40 Tires
Max. Load Cap. per Tier	500 lbs	500 lbs	500 lbs
Ship Weight	73 lbs	95 lbs	119 lbs

Tire Changing Tools & Equipment

TITAN

TIT-85533 **\$50⁸⁵**
5-Pc Motorcycle/ Small Air-Filled Tire Spoon Set with Rim Guards

- Polypropylene rim guards are included to protect tire rims from scratches and scuffs and the rope handles prevent guard loss inside of tires



OTC

OTC-5736-30 **\$83⁹⁵**
30" Curved Tire Spoon



OTC

OTC-5732 **\$141³⁵**
Tire Spoon Holding Pliers



OTC

OTC-5733 **\$122³⁵**
Tire Bead Wedge Pliers



Tire Changing Tools & Equipment



Tire Irons and Bead Breakers

Item #	Model	Description	Stock	
KEN-32120	T20	24" Curved Tire Mount/DEMOUNT Spoon	11/16"	\$55.65
KEN-33220	T20A	30" Curved Tire Mount/DEMOUNT Spoon	11/16"	\$62.05
KEN-33219	T19A	30" Straight Tire Mount/DEMOUNT Spoon	11/16"	\$62.05
KEN-33341	T41	30" Swan Neck Leverage Bar	7/8"	\$113.25
KEN-33342	T42	30" Bead Breaker	7/8"	\$113.25
KEN-32116	T16A	16" Tire Iron for Small Tires	7/16"	\$40.25
KEN-34645	T45A	37" Super Duty Tubeless Truck Tire Iron	3/4"	\$131.45
KEN-34645C	T45AC	37" Classic Super Duty Tubeless Truck Tire Iron	3/4"	\$151.75
KEN-34647	T45HD	41" HD Tubeless Truck Tire Iron	7/8"	\$168.05
KEN-34747	T46A	36" Straight Standard Tubeless Truck Tire Iron	3/4"	\$126.55
KEN-34848	T47B	49.5" HD Straight Tubeless Truck Tire Iron	1"	\$326.25
KEN-34847	T47A	52" HD Straight Tubeless Truck Tire Iron	1"	\$313.35
KEN-35329	T11E	30" Bead Breaking Wedge with Wood Handle		\$202.85
KEN-35429	TG11E	32" Bead Breaking Wedge with Fiberglass Handle		\$233.85



ESC-10202

"Combi" Bead Breaker Kit

- Bead breaker works on single, two and three-piece truck tires/rims, including some new style wheels

Kit includes:

- #10101 - 13.8 ton "Combi" bead breaker tool
- #10592 - 5 quart hydraulic air pump
- #10604 - 8' Hose assembly with hose coupler
- #10601K - 6" whip-hose and air reducer



ESC-70160 **\$187⁴⁵**

Manual Bead Breaker

- For small ATV tires and up
- Works on the tire without removing the wheel
- Will handle 38" and 42" 14-ply farm tractor and backhoe tires with drop center rims to small ATV and lawn mower tires
- Operates with air ratchet wrench or ratchet & socket



ESC-70150 **\$179⁷⁵**

Heavy-Duty Slide Hammer Bead Breaker



AME-71500 **\$149⁹⁵**

Big Buddy Bead Breaker Slide Hammer

- Spring-action tip reduces kick-back



ESC-10165 **\$1570¹⁵**

5-Ton Capacity Dual Wheel Agricultural Tire Bead Breaker

- To be used on dual wheel agricultural tires to break inside bead on outside tires, eliminating the need to remove the tire off of dual farm tractors
- Min./Max. spreader opening: 4.5"-12" wide
- Designed to be used with a hydraulic pump, hose, and other accessories (not included)



AST-7449 **\$33³⁵**

20" Tire Iron Spoon Lever

- Separates most tires and works with most tire machines



ESC-20408 **\$897³⁵**

Pneu-Tek Universal Impact Driven Pneumatic Tire Demount Tool

- Tackles the hard 19.5" reverse hubs and grader tires
- Can be used on all tire sizes from 10" ATV tires and up
- Great for agricultural tires, one-piece grader, loader, forestry and back hoe tires



WHEEL & TIRE MAINTENANCE

Tire Changing Tools & Equipment



ESC-90518-100-KIT **\$545¹⁵**

Truck Tire Demount & Mounting Tool Kit

- Demounts 22.5" to 24.5" tubeless truck tires
- Mounts all tubeless tires 17.5" through 24.5"
- Bead holder tool keeps truck tire bead from slipping during mounting of top bead



AME-71050 **\$515⁵⁵**

Golden Buddy Tire Changing System

- Mount and demount tools for 22.5" and 24.5" tires/wheels
- Comes with a bead holder tool

FREE!
While quantities last

Buy #AME-71050 and obtain #AME-71500 for free: Big Buddy Bead Breaker Slide Hammer.

Bead Seaters



Second Generation Bead Bazooka® Bead Seaters

- Automatic rapid air release system
- Ultra-compact tank and lightweight for easier handling

Item #	Tank	Tire Applications	
GAI-GBB3L2	3L	ATV, Motorcycle, Car, and Light Commercial Vehicles	\$465.05
GAI-GBB6L2	6L	Motorcycle, Car, Light Truck, and Heavy Commercial Vehicles	\$565.15
GAI-GBB10L2	10L	Car, Light Truck, Heavy Commercial, and Light Agricultural Vehicles	\$663.85



Hurricane™ Bead Seaters with Lightweight Aluminum Tanks

- Fast, easy and powerful push-button style discharge system
- Steel casing helps protect safety valve and pressure gauge
- Max. 165 PSI
- Protective rubber coated feet

Item #	Tank Size	Dimensions	Weight	
ESC-20387	5 Gallon	30" x 11" x 12.5"	19 lbs	\$503.15
ESC-20388	9 Gallon	28" x 14" x 14.5"	23 lbs	\$566.35
ESC-20389	13 Gallon	31" x 14" x 15"	24 lbs	\$638.75

ATD-9905 **\$401³⁵**

5 Gallon Bead Seater

- Seats beads on all tires from 4" to 24.5" sizes
- Powder coated steel tank



MRI-MBS-5 **\$280⁶⁵**

5 Gallon Bead Seater

- Compatible with Nitrogen
- 25.5" x 16.5 x 11.5" steel tank
- Weight: 26 lbs



Cyclone X-Series™ Bead Seaters with Heavy Duty Steel Tanks

- Fast and powerful discharge system
- Max. 165 PSI
- Protective rubber coated feet



Item #	Tank Size	Dimensions	Weight	
ESC-20390	5 Gallon	18" x 14.5" x 15"	31 lbs	\$326.05
ESC-20391	10 Gallon	24" x 16.5" x 17"	46 lbs	\$338.05



Cyclone™ "Classic" Bead Seater with Heavy Duty Steel Tank

- Classic designed "End Discharge" system provides greater control and stability while seating event the toughest of beads
- Long "Cowbell" style barrel locks the bead seater securely to the tire/wheel while inflating
- Works on ATV - 24.5" truck tires
- Max. 165 PSI
- Protective rubber coated feet



Item #	Tank Size	Dimensions	Weight	
ESC-20380	5 Gallon	22" x 13" x 13"	34 lbs	\$335.25

Pitman Arm & Tie Rod Tools



LIS-58100 **\$304⁸⁵**

Inner Tie Rod Tool Set

- Improved socket design to work on longer applications
- 12 sizes: 1-3/16", 1-1/4", 1-3/8", 1-1/2", 1-5/16", 1-7/16", 29mm, 32.5mm, 33.6mm, 38.4mm, 40mm and 42mm



LIS-45750 **\$149³⁵**

Inner Tie Rod Tool

- 6 sizes: 33.6mm, 1-3/16", 1-1/4", 1-5/16", 1-7/16", 1-1/2"



MAY-29912 **\$477⁵⁵**

4-Pc Interchangeable Inner Tie Rod Tool Kit

- Works with square/rectangular, or cylindrical ball joints
- Adapters: 28-34mm, 34-39mm, 39-45mm



MUK-512 002 **\$174⁵⁵**

Inner Tie Rod Multi-Grip Wrench

- Grips any round or hex surface on the rod
- Two lever lengths: 10"-15" (260-390mm)
- Grip diameter: 0.55"-0.9" (14-23mm)
- Grip width: 1.6" (40mm)



MUK-608 950 **\$147⁶⁵**

1/2" Drive Excentric Turn Chuck for Tie Rod Ends

- Special tool for servicing and adjusting tie rod ends
- Tool opens both ways to allow universal usage for easy tie rod replacement or wheel alignment



CAL-946 **\$30⁸⁵**

Inner Tie Rod Removal Tool

- Can remove inner tie rod without removing the outer tie rod



STK-71465 **\$58⁹⁵**

Tie Rod End Pliers

- Steel C-clamp locking plier provides a quick, temporary steering repair for vehicles with outer tie rod end ball and socket separation



OTC-7503 **\$127¹⁵**



Outer Tie Rod Remover

- Works on FWD and RWD import and domestic vehicles
- Up to 5 tons of force can be applied



OTC-6275 **\$134⁶⁵**



Tie Rod/Pitman Arm Adjusting Set

- Includes one Pitman arm and four tie rod tools



Astro

AST-7802 **\$75⁰⁵**

Tie Rod/Pitman Arm Adjusting Tool Set



TGR-10310 **\$209⁹⁵**



Tie Rod End Remover Set

- Provides a safe way to "shock" tie rod ends loose without risk of damage to threaded areas, rubber seals and grease nipples
- Set includes:
- 7/8" - 14: Heavy-Duty Trucks (#10301)
 - 3/4" - 16: Intermediate Size Trucks (#10302)
 - M20 x 1.5: European Trucks (#10304)



TGR-10353 **\$209⁹⁵**



3/4" Drive Tie Rod End Remover Socket

- For Class 6-8 trucks and equipment (Kenworth, Peterbilt, Freightliner, Mack, Volvo, etc.)
- I.D.: 3.0" / Slot width: 1.25"



SUN-2801 **\$27⁷⁵**

1/2" Drive Tie Rod End Socket

- Capable of removing most bolts that have 75% of their corners stripped away



SLY-18200 **\$110⁷⁵**

46mm Pitman Arm Torque Adapter

- For servicing and replacing the Pitman Arm on 2010+ Ford, GM, Dodge and other full-size pickup trucks



Pitman Arm & Tie Rod Tools

SLY-68800A **\$362¹⁵**

High-Leverage, Low Profile Pitman Arm Remover

Works on most Pitman Arm applications, including:

- Most GM 1988-2000 (and later) C and K chassis trucks and SUVs
- 2001 to current model trucks and SUVs equipped with sector shaft type steering gear



SLY-11880A **\$676⁸⁵**

Large Pitman Arm Remover



- Works with Ford F250/F350 and many 3/4 to 1 ton pickup trucks using the larger TRW steering box, and now the F450/F550 models with ZF steering gear



SLY-14900 **\$552⁵⁵**

Sheppard Pitman Arm Remover

Applications:

- M80, M90, M100, M110, 292, 392, 492 & 592
- Used on Chevy/GMC, Freightliner, Kenworth, Mack, Navistar, Paccar, Peterbuilt, Volvo, and many others



LIS-41970 **\$67⁶⁵**

Heavy-Duty Pitman Arm Puller for Ford

- For the large Pitman arms on 2005 and later Ford F250 and F350 trucks



OTC-6497 **\$181⁶⁵**

Super-Duty Pitman Arm Puller

- Works on 2005 and newer Ford F-250 and F-350 4WD Super-Duty trucks
- Maximum jaw spread is 3-1/4"



OTC-7314A **\$80¹⁵**

Pitman Arm Puller

- Will handle nearly any Pitman arm job on passenger cars and light trucks
- Spread between jaw tips: 1-5/16"



OTC-6496 **\$161⁵⁵**

Pitman Arm Puller

- Works on most domestic 4WD SUVs and pickups:
 - 1998 - 2003 Ford Navigator
 - 1997 - 2004 Ford F-150 and Expedition
 - 1991 - 2004 Oldsmobile Bravada
 - 1988 - 2005 S10/S15 GMC Trucks & Chevy Blazers
 - 1992 - 2011 Chevy Suburban
 - 1988 - 2011 GMC & Chevy 1/2-, 3/4- and 1-ton pickups
 - 1995 - 2011 Chevy Tahoe and GMC Yukon/Denali



OTC-6295 **\$300⁷⁵**

5-Pc Front End Service Set

- Includes five popular tools used for servicing Pitman arms, ball joints, and tie rods on most vehicles



CAL-18650 **\$102⁰⁵**

Heavy-Duty Pitman Arm Spreader

- Works on various pitman arms of Class 3-8 vehicles and equipment



TGR-10385 **\$241⁴⁵**

Sheppard M100 Pitman Arm Puller

TIGER TOOL



Made in Canada



TGR-10389 **\$356⁹⁵**

Sheppard M110 Pitman Arm Puller

LIS-41220 **\$242⁶⁵**

5-Pc Thick Pickle Fork Set

- 20% Thicker fork design provides extra lift when replacing worn out ball joints, pitman arms, pickup track bars and other applications



LIS-41500 **\$88⁸⁵**

Pickle Fork Set

- .401" Shank
- Fork sizes: 11/16", 15/16", 1-1/8"



ATD-8705 **\$93⁵⁵**

5-Pc Ball Joint & Tie Rod Separator Set

- 11/16", 15/16" & 1-1/8"
- 1 handle for use with manual hammer
- 1 handle for use with air hammer



OTC-6299 **\$151⁵⁵**

5-Pc Separating Fork Set

- 11" x 1-1/8"; 11-3/4" x 1-5/8"; 11-5/8" x 1-7/16"; 16" x 11/16"; 16" x 15/16"



MAY-31940 **\$288⁸⁵**

5-Pc .401 Shank Separating Fork Set

- 11/16", 15/16", (2) 1-3/8", 1-11/16"



Power Steering Service Tools

OTC-5079 **\$1383⁵⁵**

Heavy-Duty Truck Power Steering Pump Analyzer

- Applications: Eaton/Vickers, TRW, Ross, and Shepard power steering systems
- Measures 1 to 10 gallons oil flow and up to 3,000 psi of pressure



ATD-5556 **\$253⁷⁵**

Power Steering and Rack Tester

- Includes most adapters needed to test domestic cars and light trucks and some imports
- Dual 2-1/2" easy-to-read gauge records pressure from 0-2,000 psi and 0-140 BAR



King Pin Service

TIGER TOOL Made in Canada

TGR-90150 **\$2204⁹⁵**

Heavy Duty King Pin Press

- Generates 46,000 lbs of force
- Services 3/4 ton pickups up to Class 8 trucks
- For use on straight and tapered king pins from 7/8" to 2-5/32"
- Isuzu NPR and GMC/Chevrolet W-series trucks require a custom adapter (#90151)
- Not compatible with FL981 axles



TGR-90153 **\$650⁹⁵**

2-1/2" King Pin Clearance Plate

- For use in conjunction with the King Pin Press (#90150)
- This adaptor will allow the #90150 to service 2-1/2" straight and tapered king pins



TGR-15200 **\$629⁹⁵**

Tapered Torque Rod Press

- Efficiently and effectively remove transverse torque rods found on Neway and Hendrickson suspensions
- For use with up to a 1" impact tool



OTC-4240A

30-Ton Heavy Duty King Pin and Brake Anchor Pin Pusher

- Works on both straight and tapered king pins
- It accommodates sizes from 7/8" to 2" in diameter and up to 11-1/4" in length



ESC-40310 **\$37⁶⁵**
1/2" Drive King Pin Socket for Mack Trucks

- Socket diameter: 1.8"

ESCO

Axle/Spindle & Locknut Tools

LOC-855A **\$445¹⁵**

Texas Twister Air Hammer Pulling Kit

- Converts your air hammer into a pneumatic slide hammer
- Pulls axles, hub bearings, bolts, harmonic balancers, distributors, seals, axle pinion flanges, or anything else that needs to be pulled
- Includes adapters to connect to your current pullers

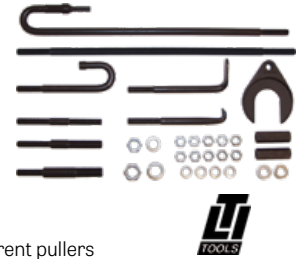

TIGER TOOL Made in Canada

TGR-11001 **\$566⁹⁵**

Axle Shaft Puller

- Easily removes axle shafts on medium to heavy-duty Dana, Eaton and Rockwell drive axles
- Commonly found on class 6-8 transportation trucks and equipment (Kenworth, Peterbilt, Freightliner, Mack, Volvo etc.)



ASM-6500X-18 **\$57⁵⁵**

1/2" Drive 12-Pt. 18mm Socket for VW Rear Axle Bolts

- Used to remove and install the rear axle bolt of various VW models
- Comparable to VW #T10162



AST-78868 **\$145³⁵**

8-Pc 1/2" Drive Extra Deep 12 Pt. Axle Nut Socket Set

- Designed for an exact fit on both 6 pt. and 12 pt. axle nuts
- The large 39mm socket works on Toyota/Lexus applications
- Includes: 29, 30, 32, 34, 35, 36, 38, 39mm



AST-78866 **\$141⁶⁵**

8-Pc Extra Deep Axle Nut Socket Set

- 6-Pt. 29mm, GM late model, Ford, Asian
- 6-Pt. 30mm, GM body styles A, J & N, Asian
- 6-Pt. 32mm, Honda, Chrysler
- 6-Pt. 34mm, GM Mid-size
- 6-Pt. 35mm, GM • 6-Pt. 36mm, GM, Ford, Chrysler
- 6-Pt. 38mm, Full-size and SUVs
- 12-Pt. 39mm, Toyota/Lexus full-size and SUV



12 Point Axle Nut Sockets

Item #	Size	Price
LIS-39510	30mm	\$29.15
LIS-39650	39mm for Toyota	\$35.05



LIS-31550 **\$87⁵⁵**

Axle Hub Bridge Nut Socket for GM

- Removes and installs the hub bearing retaining nut found on some GM GMT900 platform full-size trucks
- Fits the new style retaining nut found on 2-wheel and 4-wheel drive Cheyenne, Silverado, Escalade, Sierra and Avalanche trucks with 10.5" or 11.5" ring gear



FRONT-END & SUSPENSION

Axle/Spindle & Locknut Tools

SUNEX
TOOLS

1/2" Drive Deep Spindle Nut Impact Socket Sets



Item #	Points	Piece Count	Size Range	
SUN-2839	6	7-Piece	29mm – 38mm	\$176.45
SUN-2837	12	4-Piece	30mm – 36mm	\$142.85
SUN-2835	12	8-Piece	29mm – 39mm	\$214.25

SUNEX
TOOLS

1/2" Drive Individual Deep Spindle Nut Impact Sockets



Item #	Pts.	Size		Item #	Pts.	Size	
SUN-2830	6	29mm	\$21.55	SUN-2800ZD	12	30mm	\$32.15
SUN-2800	6	30mm	\$21.25	SUN-2803ZD	12	35mm	\$33.35
SUN-2834	6	34mm	\$25.85	SUN-2802ZD	12	36mm	\$41.25
				SUN-2807ZD	12	39mm	\$38.15

OTC

1/2" Sq. Drive Locknut Sockets



Item #	For Servicing:	
OTC-7090A	<ul style="list-style-type: none"> • 1978-84 Ford F-series H.D. 3/4 and 1-ton 4WD trucks; • 1973-81 GM 3/4 and 1-ton 4WD trucks 	\$74.85
OTC-7157	<ul style="list-style-type: none"> • 1993+ Ford Ranger Bronco II & Explorer with manual hubs • 1995-96 Ford F-series 1/2-ton truck and full-size Bronco with manual hubs • 1995+ Ford F-series 3/4-ton & 1-ton trucks w/manual hubs • 1959-85 Ford F-series 1/2-ton and 3/4-ton trucks and full-size Bronco • 1960-90 GM 1/2-ton truck and full-size Blazer/Jimmy • 1969-89 Dodge 1/2-ton truck with manual hubs • 1969-72 International 1/2-ton truck 	\$80.05
OTC-7158	<ul style="list-style-type: none"> • 1985-1/2-95 Ford F-series H.D. 3/4-ton and 1-ton Dana 50 IFS, Dana 60 front axle • 1982-90 GM H.D. 3/4-ton and 1-ton trucks • 1994-newer Dodge Dana 60 with Cummins 	\$80.15
OTC-7269	<ul style="list-style-type: none"> • 1985-newer Ford F-series 3/4-ton and 1-ton trucks with Dana 80 rear axle 	\$96.15



CTA-1083 **\$114⁸⁵**

Ford Transit Rear Hub Nut 4-Pt. Impact Socket

- Services 2014+ RWD Ford Transit vehicles
- Comparable to Ford factory tool #205-1007



CTA-1212 **\$127⁵⁵** 12 Pin Hub Nut Socket for RAM Trucks



- Services rear axle hub bearing retaining nut on heavy duty RAM trucks: 2019+ 3500, 4500, 5500 (D2, DD, DP)
- Compare to FCA factory tool #2066600030

CTA-5900 **\$109⁷⁵** GM Hub Nut Remover/Installer Tool



- Removes and installs the hub nut on GM 11.5" & 12.0" rear axles
- Services new hub nut used on 2020+ Chevrolet Silverado & GMC Sierra 2500/3500 HD trucks 11.5" & 12.0" axles with Dual Rear Wheel hubs
- Compare to GM Factory Tool DT-52754

GRY-1708SN **\$217³⁵** 8-Pc 1/2" Drive 12 Pt. Axle/Spindle Nut Socket Set



- 29mm, 30mm, 32mm, 34mm, 35mm, 36mm, 38mm, 39mm

GWR-41660D **\$150⁷⁵** 6-Pc 1/2" Drive Spindle Nut Socket Set

GW GEARWRENCH



- Fits most 4WD SUV's & light truck axle locknut applications
- Use with a torque wrench, ratchet, or breaker bar

OTC-4543A **\$216³⁵** 6-Pc 4WD Spindle Nut Socket Set

OTC



- Covers most SUV and light truck applications
- 1/2" square drive sockets, allowing use of a torque wrench, ratchet, or breaker bar

STK-71410 **\$126²⁵** Axle Popper Fork and Shim Kit

STECK
Innovative solutions for your shop



- Breaks loose half shafts from transaxle on front wheel drive vehicles
- Shim included in kit to fill larger gap found on some vehicles

Ford Axle Shaft Seal Installers



- For use on vacuum-operated front axles
- Correctly installs the seal onto the axle shaft and into the wheel knuckle, preventing front hub vacuum leaks that would cause the 4WD to not engage

Item #	Application	
OTC-6695	1998-2004 Ford F-250, F-350, F-450 and F-550 4X4s	\$196.05
OTC-6697	2005-newer Ford F-250, F-350, 4X4s	\$201.55
OTC-6698	2005-newer Ford F-450, F-550, 4X4s	\$225.65

Wheel Hub Service Tools



Made in Canada

TBQ-1190A **\$522²⁵**

Universal Axle Shaft Puller

- Improved model
- 15 lbs slide hammer



TBQ-1197 **\$797⁶⁵**

Universal Axle Shaft Puller & Pusher Super Kit

- Includes #TBQ-1190A and #TBQ-1196



TBQ-1195 **\$518¹⁵**

Drive Shaft Pusher/Hub Puller with Extractor Jaw

- Includes #TBQ-1193 and #TBQ-1196

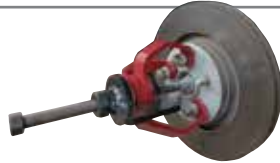

TBQ-1193 **\$267²⁵**

Three Adapter Legs

- Works with older model #CVO-1190



TBQ-1196 **\$354⁹⁵**

Extractor Jaw with 30cm Push Screw



AST-78834 **\$47⁷⁵**

AP Astro

Impact Rated Hub Removal Bolt Kit

- For press-in, bolt-in or otherwise corroded hubs that should have come out with your 1st attempt but refuse to be removed
- Simply use these impact rated bolts and nuts to push against the knuckle assembly and force the hub off



OTC-6574 **\$315⁷⁵**

Universal Heavy-Duty Hub Puller with Plate

- For use on frozen hubs, axle shafts, and other tough pulling applications
- Fits wheel hubs with 5"-8"+ bolt circles

OTC

MUK-433 414 **\$387¹⁵**

Original "VIBRO-IMPACT" Universal Drive Shaft Pusher/Hub Puller

- Pushes out bonded or heavily corroded drive shafts
- Suitable for almost all 4- and 5-hole wheel hubs with a pitch circle diameter up to 136 mm
- For use with an impact wrench (not included)



KKU-229-2 **\$700¹⁵**

10-Ton Capacity Hydraulic Wheel Hub Puller

- For all 4 and 5-hole hubs on almost all passenger cars, including VW, Audi, Volvo, Fiat, etc.
- Also for extracting drive shafts for vehicles with front wheel drive



Lisle

LIS-40100 **\$199⁰⁵**

Hub Remover

- Safely removes frozen hub assemblies without damaging other suspension components
- Fits on most 5, 6 and 8 lug hub assemblies found on cars and trucks



LOC-830A **\$284⁶⁵**

Universal Hub Removal Tool

- Ideal for Dodge and other HD trucks
- Universal fit mounts to all axle bolted hubs - 5, 6 & 8 lug hubs
- Use with 5 lb. hammer to knock frozen hubs out of axles



ATD-8629 **\$269⁸⁵**

Universal Wheel Hub Removal Tool

- Safely removes frozen hub assemblies instantly
- Will not damage axles
- Universal, fits all axle bolted hubs (5, 6 and 8 lug hubs)
- Use with 5 lb hammer to knock frozen hubs out of axles

ATD



OTC

OTC-6575 **\$1173⁴⁵**

Hub Grappler™ Kit

- For servicing wheel hubs and bearings on the vehicle without removing the steering components or knuckle
- Coverage up to 2018 model year
- Includes tie rod/ball joint tool and two Ford axle installers



OTC

OTC-6575H

Hydraulic Hub Grappler™ Kit

- Same as #OTC-6575 but also includes the Hydraulic Kit



OTC

OTC-6575-1 **\$385⁴⁵**

Hub Grappler™ Puller



FRONT-END & SUSPENSION

Wheel Hub Service Tools

CAL-90703 **\$41²⁵**
**3/8" Drive Dodge/Ram Truck
 Rear Wheel Hub Nut Socket**

- Fits rear axle locknuts of Dodge/Ram trucks with six holes
- Applications: models 1500-5500 from 2006-2014 (Chassis codes: D2, DC, DD, DH, DJ, DP, DR, DS)
- Comparable to Mopar® factory tool #8954A



STK-71310 **\$196³⁵**

Inner Race Hub Saver

- 6" steel cone cylinder with an integrated bearing in its 8.5" base
- Allows the technician to place the hub on the tip of the cone and rotate it with one hand while applying heat from an oxyacetylene torch
- While rotating the hub, the torch will raise the temperature of the inner bearing race evenly and quickly causing the race to expand and release from the hub in about **5 minutes**



Torsion Bar Tools

AST-78823 **\$87²⁵**
**Late Model GM Heavy-Duty
 Torsion Bar Unloading Tool for 2011+**

- Needed to service torsion arm and front suspension on many 2011+ full-size GM trucks
- Holds the torsion bar in place while you loosen or tighten the adjusting nut



OTC-7832 **\$168²⁵**

**GM Torsion Bar
 Unloader**

- Required to safely release the tension on the front suspension torsion bar to service the front suspension
- Larger design to cover the newer GM Truck applications: 2011-newer HD C/K trucks



Ball Joint Service Tools

CTA-1732 **\$45⁸⁵**
**41mm 12 Point BMW/Benz
 Ball Joint Impact Socket, 1/2" Drive**

- Applications includes BMW and Mercedes lower ball joint



AST-78620 **\$39⁰⁵**
Subaru Ball Joint Puller

- Removes seized bolt-in Subaru ball joints in a single pulling motion
- For Subaru Baja 2003+, Forester 1998+, Impreza 1993+, Legacy 1990+, Outback 2000+ and more



TBQ-17392 **\$97²⁵**

**9-Pc Ball Joint
 Service Kit**

- Kit includes installation and removing adapters for 1967 to current 1/2-Ton and 3/4-Ton 4WD vehicles having the Dana 44 front axle (found on Ford, GM, Dodge, IHC and Jeep vehicles)



TBQ-17398 **\$170⁴⁵**

**21-Pc Master
 Ball Joint Service Kit**

- Heavy duty tool set removes and installs ball joints, U-joints and brake anchor pins
- Includes a C-frame press and forcing screw, as well as all of the receiver tubes and adapters necessary to work on press-fit upper and lower ball joints on most Dodge, GM, Ford and other 2WD and 4WD cars, pickups, vans and SUVs through 2006



AST-7865 **\$169¹⁵**
**Ball Joint Service Tool with
 4-Wheel Drive Adapters**

- Removes and installs press-fit parts such as ball joints, universal joint and truck brake anchor pins
- Ball joint service kit allows service for 1967 thru current 1/2 and 3/4 ton 4WD vehicles having the Dana 44 front axle (found on Ford, GM, Dodge, IHC and Jeep vehicles)
- Receiver tubes: 2-3/4" x 3", 2-1/4" x 2-1/2" & 1-3/4" x 2", installation and removing adapters



AST-7868 **\$154⁷⁵**
Master Ball Joint Adapter Set

- Includes all the receiving tubes and removing/installing adapters needed to work on most GM, Ford and Dodge 2-wheel and 4-wheel drive pick-ups, vans and sport utility vehicles through 1997



AST-7897 **\$316⁸⁵**
**Ball Joint Service Tool and
 Master Adapter Set**

- Removes and replaces ball joints
- Works on press-fit upper and lower ball joints on most GM, Ford, and Dodge 2 and 4 wheel drive pick-ups, vans and sport utility vehicles through 1997



AST-78197 **\$367³⁵**
**Goliath Ball Joint Service Tool &
 Master Adapter Set**

- The C-frame press has both wider opening and longer arms to a more easily fit adapters
- Works on press-fit upper and lower ball joints on 2WD & 4WD domestic, import and Euro vehicles through the 2020's



Ball Joint Service Tools

SLY-18100 **\$1706³⁵**

High Pressure Ball Joint Press

- Designed to remove and install most ball joints with pre-fitted straight grease fittings
- Includes 9 cup sizes for most pick-up truck applications, including Ford, GM and Dodge



SLY-18100-GM **\$362¹⁵**

Ball Joint Cup Kit for GM 2500 & 3500 Pickups

- Increases the coverage of #SLY-18100 High Pressure Ball Joint Press
- Designed specifically for 2000-2010 GM 2500 & 3500 pickup trucks with steel lower A-arms
- Includes 2 cups for removal and 2 cups for installation



OTC-7249 **\$299⁰⁵**

Ball Joint Service Kit

- Removes and installs press-fit parts such as ball joints, universal joints, and truck brake anchor pins
- Contains 3 receiver tubes: 2-3/4" I.D. x 3" O.D., 2-1/4" I.D. x 2-1/2" O.D., 1-3/4" I.D. x 2" O.D.



OTC-6530 **\$750⁶⁵**

Ball Joint Intermediate Service Kit

- This 20+ adapter kit covers many Truck/Van/SUV applications and some car applications having press-in ball joints and universal joints



OTC-6559

Ball Joint Master Service Kit

- This 70+ adapter kit offers complete coverage of Car and Truck/Van/SUV applications
- Coverage up to 2008 model year



OTC-CA7149 **\$938²⁵**

Ball Joint Connected Adapter Starter Kit

- Fully compatible with existing OTC 7249, 6529, 6539, 6559 ball joint kits
- Includes 7 cups and adapters for more than 230 vehicle applications
- The connected adapter C-frame is the largest available at 2-3/4" deep x 9" wide, able to handle 3/4-ton and 1-ton suspension components



AST-78100 **\$167²⁵**

Goliath Ball Joint XL C-Frame Press

- For max clearance and easier use of tall and stacked adapters
- Includes both long and short drive screws



ATD-8695 **\$178¹⁵**

Extra-Large C-Frame Ball Joint Press

- For max clearance and easier use of tall and stacked adapters
- Presses out ball joints without removal of top-mounted grease fittings
- 9.1" throat, 11.9" length



OTC-6939 **\$276²⁵**

Broken Bolt Extractor Tool

- Remove frozen, broken or cut off bolts within steering or suspension bushings
- Can also be used to remove and install wheel studs and other general pressing needs



ATD-8700 **\$26⁹⁵**

Ball Joint Separator

- 12" x 15/16"



AST-78911 **\$40⁷⁵**

Universal Ball Joint Separator

- For separating the ball joint from the spindle support arm on domestic and import front wheel drive vehicles
- Adjustable for different size ball joints
- 1-1/8" & 2-1/8" (30 & 56mm) maximum opening capacity



AST-78912 **\$70⁸⁵**

Low Profile Impact Rated Ball Joint Separator

- Designed for tight access where most ball joint separators won't fit
- Particularly useful on 2005+ Ford, Lincoln and Mercury applications
- Designed with a longer throat to fit more applications



MUK-609 033 **\$375³⁵**

Ball Joint Separator Kit

- Designed to be used with an impact tool
- Jaw capacity: 30mm - 65mm
- 3 fork sizes: 24, 27 and 31mm
- Ideal for Audi / VW (A3, A4 and A6 with double wishbone), BMW, Mercedes-Benz



Sway Bar Link Tools



Low Profile Sway Bar Link Pliers

- Holds and easily removes sway bar link
- Strongly grips and works on rusted nuts, pipes and other objects

Item #	Size	
9CL-89102	7"	\$37.75
9CL-89501	9"	\$38.45

Strut & Coil Spring Service Tools

BRN-7600 

Strut Spring Compressor

- Handles the heaviest coil-over-shocks, on light trucks and SUV's
- No adaptors required
- Min./Max. spring diameters: 3.5"/11.5"
- Ford, GM, MOPAR, OEM approved



BRN-764 **\$821⁶⁵**



Mobile Cart for Strut Spring Compressors

- Allows for full mobility and a sturdy stand for your strut spring compressor
- Fits both Branick models #7400 and #7600



OTC-6637-ST 

Strut Tamer II Extreme with Mobile Stand

- Capable of safely compressing the largest strut springs
- Min./Max. spring diameters: 2-1/2" to 10"
- Vertical stroke: 1-1/4" to 24"



CAL-91300 **\$672⁵⁵**



Floor Mounted Strut Compressor

- Designed for easy, one-person use
- Ideal for passenger vehicles and light-trucks
- Adaptive spring bracket for multiple configurations
- 19" max. spring height
- Min./Max. spring diameters: 3" to 9"
- Max. coil diameter: 5/8"



OTC-6494 **\$499⁵⁵**

Clamshell MacPherson Strut Spring Compressor

- Fits a wide range of struts and requires no special adapter shoe
- Tool compresses springs of 4" to 9" O.D., with wire diameters of 7/16" to 11/16"
- Built to use with an impact wrench



CTA-8200 **\$923⁹⁵**

Strut Lifter

- Supports the strut on the vehicle up to 500 Kg (1102.31 lbs)
- Services removal and installation of struts, drive shaft, control arms, wheel hubs and ball joints
- Mounts onto 30mm diameter hydraulic transmission jack post
- Adjustable depth and tilt
- Includes medium jaw (#CTA-8200X02)

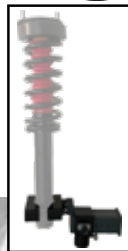

SCAN TO WATCH THE VIDEO



9CIRCLE®

9CL-20011 **\$473⁵⁵**

Rear Coil Spring Compressor

- Easy access to rear coil springs, no need to remove the rear control arm
- For BMW (3 Series), Audi A4 & A6, Chrysler, Chevrolet, Ford, Honda, Hyundai, Mazda, Mercedes-Benz, Mitsubishi, Suzuki, Toyota, Lexus



9CL-20073 **\$723¹⁵**

MacPherson Strut Coil Spring Compressor

- Suitable for Audi, Acura, MB, BMW, Ford, Honda, Mitsubishi, Nissan, Porsche, Subaru, Toyota, VW, Volvo...
- Recommended ON-CAR application for Mercedes 4WD front suspensions



ATD-7549 **\$93⁸⁵**



Coil Spring Compressor

- Fits most American and some imported cars and light trucks
- Does not work on AMC and Ford with upper coil spring



ATD-7550 **\$197²⁵**

Master MacPherson Strut Spring Compressor Set

- Fits most American and some imported cars and light trucks (except AMC and Ford with upper coil spring)



ATD-7585 **\$105⁷⁵**

Master MacPherson Strut Tool

- Designed to compress most sizes of MacPherson strut springs
- Also allows for repairs on bent struts, strut tubes and damaged pieces

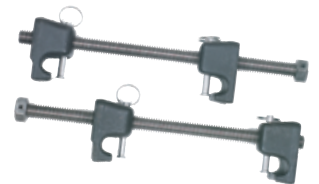

SUNEX TOOLS **\$69⁹⁵**

Spring Compressor

- Ideal for removal & installation of auto and light truck coil springs

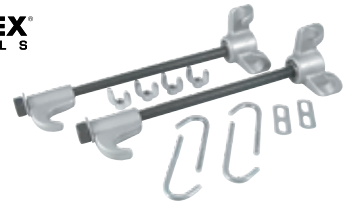

CTA-4005 **\$21⁶⁵**

VW/Audi Suspension Strut Housing Nut Socket

- Oval shaped bit end services Suspension Strut Housing Nuts found on mostly newer VW & Audi models
- Fits some BMW, Seat, Renault, Peugeot and other European makes



Leaf Spring Service

TIGER TOOL  Made in Canada

Leaf Spring Pin Sockets

- 1/2" drive



Item #	Applications	Distance Between Pins x Pin Diameter	
TGR-15103	Mack/Volvo Suspensions	0.945" x 0.355"	\$76.65
TGR-15105	Western Star Suspensions	0.880" x 0.305"	\$76.65

ESC-40309 **\$35²⁵** 1/2" Drive Leaf Spring Socket for Mack/Volvo

- Socket diameter: 1.45"
- Pin diameter: 0.35" (9mm)



ESCO

Air Suspension Pressure Testers



CTA-5171 **\$76⁵⁵**

Mercedes-Benz Air Suspension Pressure Tester

- Accurately displays the air suspension pressure during service
- Helps detect leaks and/or irregularities in pressure throughout the air suspension system
- Gauge displays both PSI & 100XkPa
- Mercedes Benz adapter measures: 8mm x M1.0
- Common issue on W220 S-Class & W211 E-Class models

CV Boots



CV Flex Boots

Item #	Application	
FLB-FB2000	ATVs and Small Cars (Axles 14.26mm - 19mm)	\$24.55
FLB-FB3000	Mid-Sized Cars (Axles 19mm - 24mm)	\$24.55
FLB-FB3001	SUVs and Cars (Axles >24mm)	\$31.95
FLB-FB3002	Toyota-Style CV Joints (Axles >24.3mm)	\$29.05
FLB-FB4000	Universal Rack & Pinion Boot – Can be installed without removing the rack, eliminating the need for alignment.	\$27.65



FLB-FB5025-34 **\$69⁷⁵** 50-Pc Universal Technology Gomex® Clamps

- Can be used on CV boots and radiator hoses
- 25 large and 25 small clamps

Lower Control Arm Tools



TBQ-1199 **\$215⁷⁵**

Lower Control Arm Triple Action Tool

- For CV axle and strut repair
- Makes strut replacement easy
- Removes ball joints without damage
- Re-installs lower control arm



AST-78914 **\$113⁹⁵**

Lower Control Arm 4 Ft. Pry Bar

- Use leverage to pull down on and free lower control arms and double wishbone suspension
- Aids in getting ball-joints free from knuckles
- Keeps control arms out of the way to service axles, knuckles, front and rear struts and more



CTA-3755 **\$13⁹⁵**

19mm 10-Pt. Honda/Acura Lower Control Arm Socket

- Applications include 2001+ Honda Civic and Acura RSX rear trailing arms



10



Camber Adjusters

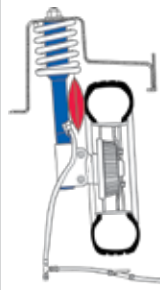

JDI-TC-614 **\$334¹⁵**

TOMCAT – Air-Assisted Multiple Camber Adjustment Tool

- Works on many GM and Chrysler vehicles using two-bolt lower strut mounts
- Inflatable air bladder fits between tire and strut for easy and controlled adjustment of camber settings
- Safety relief valve to prevent overinflating



SGT-61800 **\$65⁸⁵**

Magnetic Strut Alignment Level

- Use to restore a vehicle's camber setting after strut repair or installation
- Also useful for repairs on CV joints, ball joints and tie rod ends
- Works on all vehicles equipped with MacPherson struts



Suspension Wear Indicators

MUK-432 910 **\$147⁶⁵**

Suspension Wear Indicator

- Helps identify all kinds of worn suspension components
- Allows user to positively SEE, FEEL and HEAR problem areas while performing diagnostics



Cooling System Pressure Testers

MOTORAD Formerly **Stant**



Cooling System Adapters

Item #	Application	Price
STA-3015	Threaded cooling adapter for GMC trucks	\$322.05
STA-3116	Threaded cooling system adapter for late model Audi, Porsche, VW, Mack Pinnacle & Volvo VN Series trucks	\$60.75
STA-3125	Cooling adapter for Japanese cars	\$154.55
STA-3126	Cooling adapter for some GM, Ford cars and trucks, as well as some Navistar, Kenworth, and Sterling	\$84.35
STA-3130	System testing adapter for 1990 and newer Volkswagen	\$138.65
STA-3030	Threaded system testing adapter for most BMW and Land Rover	\$150.45
STA-3127	Threaded system adapter for many late model GM cars and trucks, also Freightliner and IHC trucks	\$205.35
STA-3128	Threaded cap adapter for many late model GM cars and trucks, also Freightliner and IHC trucks	\$85.45
STA-3036	Threaded system adapter for many late model Audi, Porsche and Volkswagen cars	\$222.15
STA-3038	Threaded system adapter for late model Mercedes	\$258.05
STA-3040	Threaded system adapter for many late model Ford, Mazda, and Mercury	\$222.65
STA-3042	Threaded system adapter for many Volvo medium and heavy-duty trucks	\$117.55
STA-7006-KT	Truck adapter kit fits all popular trucks with the large diameter (2-11/16" O.D. "B" size) filler neck	\$68.45

AST **ASSENMACHER** SPECIALTY TOOLS

Made in USA

ASM-FZ52LHT **\$123²⁵** Coolant Pressure Adapter for GM Trucks

- Applicable to 2017 and newer Duramax engines with M52 x 2.5 left hand threaded coolant reservoirs



REDLINE TOOLS

Made in USA

RDL-95-0750 **\$166⁴⁵** SmartFit™ Universal Radiator Adaptor Set

- Pressure tests cooling systems in all vehicles
- Fits every radiator and/or plastic reservoir
- Works with any pressure pump



MIT-MV4508 **\$89⁵⁵** Universal Cooling System Adapter

- Replaces more than 20 individual cooling system pressure test adapters for cars, vans, light- and heavy-duty trucks
- Compatible with Stant-style cooling system pressure pumps

mityvac



MOTORAD Formerly **Stant**

STA-MT300 **\$228⁶⁵** Engine Coolant System Pressure Tester (Improved Stant #12270)

- Tests cooling systems and pressure caps up to 30 lbs/207 kPa
- Comes in a blow molded case



mityvac

MIT-MV4560 **\$109²⁵** Cooling System Pressure Test Kit

- Kit includes four cooling system test adapters and two dual-function cap test adapters to quickly reveal external cooling system leaks and detect internal leaks and defective caps
- Tests most US and Asian cars and light trucks, as well as many European vehicles



MIT-MV4534 **\$218⁵⁵** Cooling System Pressure Tester

- Pressure testing for leaks in automotive cooling systems
- Universal cooling system adapter replaces more than 20 individual adapters for cars, vans, light- and heavy-duty trucks



REDLINE TOOLS Made in USA

RDL-95-0700 **\$251⁸⁵** SmartFit™ Universal Cooling System Test Kit

- The SmartFit™ test kit expands to fit 100% of passenger vehicles and light-duty trucks on the road today
- Includes a universal radiator adapter set that fits every radiator and/or plastic reservoir



HICKOK WAEKON Made in USA

WAY-62968 **\$844⁶⁵** Heavy-Duty Cooling System Test Kit

- Compatible with: Freightliner, GMC, International, Kenworth, Mack, Peterbilt, Sterling, Volvo
- Lifetime warranty on adapters



Cooling System Pressure Testers

ATD-3302 **\$409⁸⁵**



25-Pc Master Cooling System Pressure Test Kit

- Quickly reveals external cooling system leaks
- Detects internal engine leaks
- Manual pump with colour coded 0-35 psi gauge
- Temperature gauge
- (3) Chromed steel radiator adapters
- (18) Anodized aluminum radiator adapters
- (2) Radiator cap test adapters
- For most popular domestic and import cars and trucks



ATD-3301A **\$451⁰⁵**

27-Pc Master Cooling System Pressure Tester and Refill Kit

- Hand pump with 0-35 psi gauge
- Temperature gauge
- (3) Chromed steel radiator adapters
- (16) Anodized aluminum radiator adapters
- (1) Universal radiator adapter
- (2) Radiator cap test adapters



MTC-43301-A **\$454²⁵**

27-Pc Master Radiator Pressure Tester & Refill Kit

- Hand pump with 0-35 psi gauge
- Temperature gauge
- (3) Chromed steel radiator adapters
- (16) Anodized alumin. radiator adapters
- (1) Universal radiator adapter
- (2) Radiator cap test adapters



MTC-43306 **\$606⁴⁵**

Heavy-Duty Cooling System Pressure Tester and Refill Kit

- (5) Quick disconnect vacuum attachments provide quick refilling of the cooling system and eliminate air pockets
- For use with Freightliner, International, Kenworth, Peterbilt, Mack, Volvo, GMC and Sterling cooling systems



ATD-3307 **\$690⁵⁵**

Heavy-Duty Cooling System Pressure Tester and Refill Kit

- (5) Quick disconnect vacuum attachments provide quick refilling of the cooling system and eliminate air pockets
- For use with Freightliner, International, Kenworth, Peterbilt, Mack, Volvo, GMC and Sterling cooling systems



AST-7856 **\$67⁶⁵**

Cooling System and Pressure Cap Tester

- Uses shop air to pressurize and test cooling systems and caps
- Works on nearly all brands of testing caps and adapters
- Gauge displays the common pressure levels for different cooling systems up to 30 psi



AST-78585 **\$543⁴⁵**

Universal Radiator Pressure Tester & Vacuum Type Cooling System Kit

- Allows easy testing for leakage in radiator system and quick change of coolant
- Suitable for domestic and import vehicles



ATD-3300 **\$281¹⁵**

Universal Cooling System Pressure Test Kit

- Manual pump with colour coded 0-35 psi gauge
- (4) Chromed steel cap adapters
- (8) Anodized aluminum cap adapters
- For most popular domestic and import cars and trucks



ATD-3305 **\$117⁷⁵**

10-Pc Cooling System Pressure Test Adapter Update Kit

- For use with #ATD-3300
- Includes 8 radiator adapters and 2 radiator cap test adapters to fit most popular domestic and import cars and light trucks
- Applications: GM, Ford, Jeep, BMW, Mazda, Mercedes, Toyota, Volvo, VW and more



Cooling System Refillers & Evacuators



ATD-3306 **\$159⁵⁵**
**Vacuum Type Cooling System
 Purge & Refill Kit**

- No need for air bleeding after refilling new coolant
- Conical adapter offers a wide application to different radiator filler necks
- Kit includes 1 universal radiator cap



MTC-43013 **\$132³⁵**
**Vacuum Type Cooling System
 Purge & Refill Kit**

- No need for air bleeding after refilling new coolant
- Conical adapter offers a wide application to different radiator filler necks
- Kit includes 1 universal radiator cap



UVW-550000 **\$304⁹⁵**
**Airlift™ Cooling System
 Refiller Kit**

- Eliminates airlocks in vehicle cooling systems
- Eliminates time consuming bleeding and purging
- Checks for leaks while under vacuum
- Works on: Cars, Trucks, Off-Road Vehicles



UVW-550500HD **\$244⁴⁵**

**Airlift™ HD
 Cooling System Refiller**

- Eliminates airlocks, bleeding and purging in heavy-duty vehicle cooling systems
- Checks for leaks while under vacuum
- Includes a cone adapter to fit most systems with an extra-long 8 ft. hose
- OEM approved by International Truck



UVW-550500 **\$171¹⁵**

**Airlift™ II
 Cooling System Refiller**

- Eliminates airlocks
- Refills the entire cooling system in seconds, including the heater core
- Eliminates time consuming bleeding and purging
- Checks for leaks while under vacuum
- Push Button Valve eliminates the need to change hoses
- Works on all cooling systems with "Fits-All" cone adapter



CTA-6520 **\$178⁶⁵**
**Cooling System
 Vacuum Purge & Filler**

- Purges trapped air from cooling system
- Tests for coolant system leaks
- Refills cooling system quickly and cleanly
- Rubber body adapters cover most vehicle radiators



MIT-MV4535 **\$297¹⁵**
**Cooling System
 AirEvac Kit**

- Kit refills automotive cooling systems in minutes without trapping air
- Universal adapter forms an airtight seal with all radiator and coolant bottle necks. No custom adapters are required.



9CL-70120 **\$153⁸⁵**
**Cooling System Vacuum
 Purge and Refill Kit**

- Coolant is easily refilled by creating a vacuum in the radiator
- Eliminates airlocks created while refilling coolant
- Checks for leaks and refills in seconds
- Includes a universal adapter with 3 rubber rings: 5mm, 39.5mm, 44mm



LIS-24780 **\$73⁶⁵**
**18-Pc Spill-Free®
 Clear Coolant Funnel**

- 5 colour-coded adapters and 6 caps fit most cars, pickups, trucks and many farm tractors



LIS-24680 **\$54⁵⁵**
**15-Pc Spill-Free®
 Clear Coolant Funnel**

- Five adapters fit most domestic and import cars and light trucks including newer GM "threaded style" radiator openings and Ford surge tanks



ASM-VTC100 **\$111⁵⁵**
Volvo Truck Coolant Drain Hose

- Used to drain the coolant of Volvo D11, D12, D13 diesel engines 2004-2018, and Mack Trucks 2007-2018
- Comparable to factory Volvo #9996049



Cooling System Refillers & Evacuators



Cooling System Flushers

- Combines water with compressed air to effectively flush vehicle cooling systems
- #MV7270 includes a spray washer nozzle for multi-surface cleaning
- Nozzle fits hoses from 3/4" to 2"
- Working pressure: 85-150 psi • Swivel inlet: 3/4" • Air inlet: 1/4"



Item #	Description	Price
MIT-MV7270	Spray Washer & Cooling System Flusher	\$183.45
MIT-MV4570	Cooling System Flusher	\$167.95



OTC-6976 \$463⁴⁵ Cooling System Refilling Gun

- Eliminates airlocks and system bleeding when refilling cooling systems
- Included small and large cones fit passenger and commercial vehicles for more applications
- Standard 1/4" NPT female thread for shop air connection (coupler/plug not included)
- Creates a vacuum within the cooling system, pulling air from the system while pulling in new coolant



Fan Clutch Wrenches



LAN-3406 \$63⁴⁵

6-In-1 Double-Ended Fan Clutch Wrench

- 22, 32, 36, 40, 48 & 50mm
- Offset wrenches provide better hand alignment and a clearer line of sight, while improving accessibility in tight fan clutch areas



LIS-43300 \$286¹⁵

8-Pc Pneumatic Fan Clutch Wrench Set

- Set includes 7 driving wrenches that fit Ford, GM, Chrysler & Jeep
- Sizes: 32mm, 36mm, 40mm, 47mm, 7/8", 1-7/8", 2"

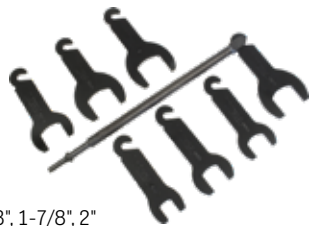

LIS-43350 \$335⁹⁵

10-Pc Pneumatic Fan Clutch Wrench Set

- Set includes 9 driving wrenches that fit Ford, GM, VW, BMW, Chrysler and International
- Sizes: 7/8", 32mm, 36mm, 40mm Thin, 47mm, 1-7/8", 2", 52mm, and 2-1/8"

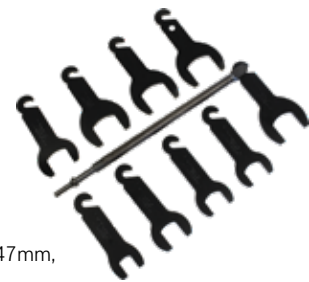

LIS-44180 \$64⁷⁵

Fan Clutch Spanner Wrench

- For GM, Jeep and Dodge Trucks, Vans and SUVs with pressed on water pump pulleys



LIS-43580 \$35⁵⁵

Fan Clutch Spanner Wrench for GM/Dodge

- Double-sided tool that fits GM gas engines 2000 and newer, Jeep and Dodge 2000 and newer, except 2009 and newer Hemi



GWR-41580D \$210¹⁵

Fan Clutch Service Set

- Covers most vehicles with bolt on pulleys and also newer Chrysler engines with press on pulleys requiring special pins to hold housing
- Includes a universal pulley holder



SLY-61200 \$195⁰⁵

2-Pc Fan Clutch Wrench Kit

- Specially designed contoured water pump holder that is exceptionally easy to use on vehicles using bolt on water pump pulleys to remove and replace the viscous fan clutch
- Applications: Chrysler, GM, Ford, Land Rover and Mazda (Not including the 4.9L 6 cylinder Ford)



ATD-8614 \$170⁷⁵

Variable Pin Spanner Wrench

- Universal design
- Adjusts from 1-1/4" to 5"
- Accommodates metric size pin configurations including: 3.5, 4, 4.5, 5, 6, 7 and 10mm

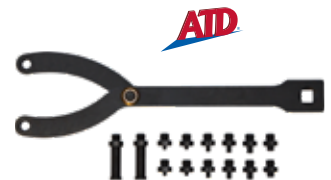

COOLING SYSTEM MAINTENANCE

Cooling System Service Tools

LIS-35650 **\$69⁷⁵**

Lisle



Heavy Duty Vehicle Thermostat Seal Installer

- Used on most CAT, Cummins and Detroit Diesel engines (Class 7 and 8 Trucks)



LIS-22500 **\$37⁸⁵**

Thermostat Gasket Cleaner

- Includes interchangeable short shaft



LIS-60900 **\$63⁴⁵**

Heater Core Backflush Tool

- Adjustable pressure industrial spray gun
- The tip fits 1/2", 5/8" and 3/4" hose fittings



LANG Made in USA



LAN-854 **\$96¹⁵**

2-Pc HD Hose Removal/Installer Set

- Set includes straight and bent profile removers

9CIRCLE



9CL-41112 **\$51⁶⁵**

10-Pc Quick Fluid Stopper Set

Anti-Freeze & Coolant Testers

TEX-106 **\$24⁴⁵**

Cold-Chek® Professional Anti-Freeze Tester

- Accurate at all temperatures
- Tests ethylene glycol-based coolant, hot or cold, including Dex-Cool®
- Celsius and Fahrenheit scales



THEXTON
MANUFACTURING COMPANY

ATD-1106 **\$11⁷⁵**

Antifreeze & Coolant Tester

- Works for all ethylene glycol coolants, including GM Dex-Cool™
- Celsius and Fahrenheit scales



ATD

EZR-SP102 **\$14⁸⁵**

Anti-Freeze Hydrometer

- Tests ethylene glycol solutions
- Range: 32°F to -60°F (0°C to -50°C)
- Tests both hot and cold solutions
- Tests Dex-Cool®



EZRED

ATD-1105 **\$9⁶⁵**

Deluxe Antifreeze & Coolant Tester

- Works for all ethylene glycol coolants and GM Dex-Cool™
- Celsius and Fahrenheit scales

ATD



Coolant Dyes

483908



UVIEW

B483906



Radiator Coolant Dye

- For use with regular (green) coolant
- Pinpoint leaks in cooling systems, including radiator, hoses, fittings, water pumps and head gaskets

Item #	Unit Size	Max. Applications	Qty	
UVW-483908	8 oz/240 ml	8 vehicles	1	\$33.65
UVW-B483906	1 oz/30 ml	6 vehicles	6	\$34.05

TRACERLINE®

HBF-TP-3940-0601 **\$35⁶⁵**

OEM-Grade Rite-Blend™ Universal Coolant Dye

- For both conventional & extended-life coolants
- Works with all leak detection flashlights
- Dye fluoresces yellow-green
- (6) 1 oz (30 ml) bottles, services up to 6 vehicles



LF3008



LEAK-FINDER®

LF3001CS



LF3001



Coolant Leak Detection Dye

- Finds leaks in radiators, hoses, heater cores, water pumps and fittings
- Works with all leak detection flashlights
- Glows green

Item #	Unit Size	Max. Applications	Qty	
LKF-LF3001CS	1 oz/30ml	1 vehicle	1	\$10.15
LKF-LF3001	1 oz/30ml	6 vehicles	6	\$29.95
LKF-LF3008	8 oz/237ml	8 vehicles	1	\$33.55

Serpentine Belt Tools

OTC GEARWRENCH

GWR-3680D **\$105¹⁵**

15-Pc Ratcheting Serpentine Belt Tool Set

- Long bar
- Ratcheting wrench
- 3/8", 1/2" and 3/4" adapters
- 6 pt. sockets: 13, 14, 15, 16, 17, 18 and 19mm
- Crowfoot: 13, 14 and 15mm



LANG

LAN-5333 **\$187³⁵**

9-Pc Fine Tooth Serpentine Belt Wrench Set

- (8) 6-point square drive adapters: 13mm (1/2"), 14mm (9/16"), 15mm, 3/8", 16mm (5/8"), 18mm, 19mm (3/4"), 1/2"



Made in USA

OTC GEARWRENCH

GWR-89000 **\$146⁹⁵**

15-Pc Serpentine Belt Tool Set with Locking Flex Head Ratcheting Wrench

- Long bar
- 6 pt. sockets: 13, 14, 15, 16, 17, 18 and 19mm
- 3/8", 1/2" and 3/4" adapters
- Crowfoot: 13, 14, and 15mm



CTA-1016 **\$140³⁵**

2-Pc Mini Cooper Serpentine Belt Tool Set

- 22" wrenches with one small and one large 12 point openings service late model Mini Coopers N12, N14, N16, & N18 engines

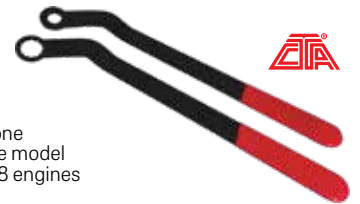

ATA

CTA-3884 **\$89²⁵**

BMW/Mini Alternator Belt Tensioner Release Tool

- Removes and installs the serpentine belt on B36, B38, B46 & B48 engines
- Services 2014+ B36/B38 (3-cylinder) and B46/B48 (4-cylinder)
- Comparable to BMW factory tool #2365291



ATA



OTC GEARWRENCH GWR-3684D **\$52⁰⁵**
27" Serpentine Belt Grabber Tool

LIS-59370 **\$35⁵⁵**

Stretch Belt Remover/Installer

- Unique magnetic faces hold the tool in place on the pulley

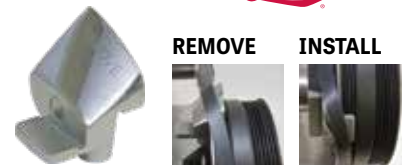

Lisle

REMOVE INSTALL

Lisle

LIS-59650 **\$180³⁵**

11-Pc Ratcheting Serpentine Belt Tool Kit

- 13-19mm sockets
- 3/8" and 1/2" square drives



LIS-59350 **\$50⁷⁵**

Stretch Belt Tool for Ford 3.5L & 3.7L

- Used to install the main stretch belt on extra deep double pulleys
- Works on 2011 and newer Ford 3.5L EcoBoost and 3.7L engines, as well as 2019 and newer GM 5.3L and 6.2L engines

Lisle



Water Pump Tools

Lisle



LIS-13500 **\$31⁴⁵**
41mm Water Pump Wrench for GM 1.6L

- Works on 1.6L engines in 2004-current Chevrolet Aveo excluding 2009 with variable timing engine and 1999-2002 Daewoo Lanos

Lisle



LIS-14440 **\$44⁴⁵**
Water Pump Wrench for GM Northstar

- Removes & installs the water pump assembly on GM Northstar 4.0L & 4.6L engines

OTC



OTC-6616 **\$103³⁵**
GM Water Pump Holding Tool

- Holds timing chain in place so water pump can be removed for service
- Special design allows easy installation regardless of timing chain orientation
- Works on 2002-2009 GM 2.2L and 2.4L EcoTech engines

Compression Testers



LAN-TU-30A **\$285⁴⁵**

Compression Tester Set

- Tests compression on all domestic and foreign cars and light trucks with gasoline engines, including mini engines
- The 2-1/2" gauge has a dual scale dial with ranges from 0-300 PSI and 0-21 bar

LANG
TOOLS

mityvac

MIT-MV5530 **\$132⁹⁵**

Compression Test Kit

- Includes adapters for use on motorcycles, marine and small engines and an air-hold adapter for performing valve seal repairs without removing the cylinder head(s). Not for use on diesel engines.
- Max. pressure: 300 psi (21 kg/cm²) (20.5 bar) (2,070 kPa)



LAN-TU-3PB **\$103²⁵**

Universal Compression Tester Set

- Tests compression on domestic and foreign cars and trucks with gasoline engines
- Adapters included: 14mm & 18mm short solid, 14mm & 18mm long flex, and 14mm long reach
- Gauge: 0-300 PSI and 0-21 Bar



MIT-MV5532 **\$250¹⁵**

Digital Gasoline Engine Compression Test Kit

- Stores maximum compression value for up to 12 cylinders
- Includes adapters for use on motorcycles, marine and small engines and an air-hold adapter for performing valve seal repairs without removing the cylinder head(s). Not for use on diesel engines.
- Max. pressure: 300 psi (2,070 kPa) (20.7 bar)



ATD-5639 **\$276⁷⁵**

ATD

Super Compression Tester

- Tests compression on all domestic and imported cars and light trucks, gasoline engines and mini engines

Adapters included:

- M14 & M10 with short thread
- M14 with long thread
- M12 x M16
- M14 adapter extension



ATD-5659 **\$110²⁵**

ATD Manufactured By **LANG**
TOOLS

Universal Compression Tester

- Tests compression on all domestic and imported cars and light trucks and gasoline engines
- Include adapters: 14 and 18mm short solid, 14 and 18mm long flex, and 14mm long reach
- 2-1/2" gauge with dual scale: 0-300 psi and 0-21 BAR



TOOL AID
PROFESSIONAL AUTOMOTIVE TOOLS

SGT-34020 **\$53¹⁵**

12mm & 16mm Compression Test Adapter for Ford Triton Engines

- Dual threaded male adapter
- 16mm-1.50 male threads: for use on 3 valve Triton engines 2004 to 2008 5.4L Ford F-150, and 2005 4.6L Ford Mustang
- 12mm-1.25 male threads: for use 2009+ Triton 4.6L, 5.4L and 6.8L engines



OTC-5606 **\$151⁵⁵**

OTC

Compression Tester Kit for Gas Engines

- For domestic, imports, motorcycles, marine, and small engines
- 2-1/2" gauge with 26" flex hose
- Reading: 0-300 psi & 0-2,100 kPa
- 12" flex-14mm standard reach
- 12" flex-14mm long reach
- 10, 12, 18mm adapters



CTA

CTA-2012 **\$165⁸⁵**

Master Compression Tester Kit

- Reading: 0-300 PSI / 0-21kg/cm²
- 8" flex hose
- 14 & 18mm threaded adapters
- 10mm, 12mm & 14mm adapters
- Straight extension, offset and straight adapters with tapered cones



OTC-5605 **\$171⁶⁵**

Deluxe Compression Tester Kit for Gas Engines

- Standard and specialty adapters
- 2-1/2" gauge with 26" flex hose
- Reading: 0-300 psi & 0-2,100 kPa
- 8" deep well 14mm connector
- 7" flex Ford Triton 16mm adapter
- 12" flex-14mm standard reach
- 12" flex-14mm long reach
- 10, 12, 18mm adapters



CTA-2006 **\$73⁹⁵**

Compression Tester

- 15" flex hose
- Side release valve permits multiple readings without removing tester
- Brass quick disconnect coupler and 14 & 18mm spark plug fittings
- 2-1/2" gauge: 0-300 PSI / 0-21kg/cm²

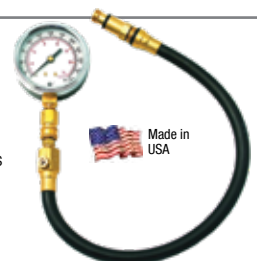

Made in USA

Diesel Compression Testers

LANG
TOOLS

LAN-TU-15-53 **\$422¹⁵**

Diesel Compression Test Set

- This is a great basic set and a must have for diesel work in the American market
- Includes adapters for GM, Isuzu, Lincoln Mark VII Continental and Ford / Navistar, Audi, Mercedes, Peugeot, Toyota, VW, Volvo



LANG
TOOLS

LAN-TU-15-55 **\$568⁹⁵**

Diesel Compression Test Set for Light Duty Trucks



LANG
TOOLS

LAN-TU-15-70 **\$918⁴⁵**

Diesel Compression Test Set for Heavy-Duty Trucks & Equipment



LANG
TOOLS

LAN-TU-15-82 **\$132⁵⁵**

Diesel Compression Adapter for Detroit Diesel Series 60 N3 Injector

- Model year 2004 and newer



ATD Manufactured By
LANG
TOOLS

ATD-5682 **\$836⁵⁵**

Heavy-Duty Global Diesel Compression Test Set

- Includes all the most popular adapters needed to test heavy-duty trucks & equipment



OTC

OTC-5872 **\$361⁴⁵**

Compression Gauge

- Heavy-duty compression gauge with push-button release valve and quick-connect coupler
- 0-1,150 psi and 0-8,000 kPa range
- **Application:** Detroit Diesel S601 two cycle 53, 71, 92 and 149
- **Similar to:** J-6692-B



Special Use Pressure Testers

OTC

OTC-5039 **\$696⁷⁵**

Heavy-Duty Truck Charged Air Cooler Tester

- Finds air leaks in the charged air cooler systems used on Class 7 & 8 truck engines
- Kit includes 2-1/2", 0-60 psi pressure gauge, regulator and relief valve, and two safety cables
- Quick disconnect air fittings attach to a 3", 3-1/2", or 4" cooler hose



LANG
TOOLS

LAN-CLT-2PB **\$210⁷⁵**

Cylinder Leakage Tester with 2 Gauges - 100 PSI

- Measures the ability of an engine cylinder to hold compressed air; supplements a compression tester



ATD Manufactured By
LANG
TOOLS

ATD-5573A **\$211⁸⁵**

Cylinder Leakage Tester

- Measures the ability of an engine cylinder to hold compressed air pressure and supplements a compression tester
- Range: 0-100 psi and 0-7 BAR



OTC-5609 **\$171⁶⁵**

Cylinder Leakage Tester Kit

- Quickly diagnose internal engine problems such as bad rings, valves and leaking head gaskets
- Dual 2-1/2" gauges, 0-100 psi and 0-700 kPa
- Pressure regulated manifold
- 24" long, 14mm flexible hose
- 10 mm, 12mm and 18mm thread adapters for most applications



LAN-TU-24A-PB **\$205⁸⁵**

Three-Way Exhaust Back Pressure Kit

- Allows quicker and more accurate testing of exhaust blockages in catalytic converters, mufflers, etc.
- Can test in 3 different places: Oxygen Sensor, Exhaust Pipes, and Air Injection System



ENGINE SERVICE TOOLS

Special Use Pressure Testers

LAN-TU-1PB **\$64⁹⁵**
Deluxe Vacuum & Fuel Pump Tester



SGT-34580 **\$202⁵⁵**
Automatic Transmission & Engine Oil Pressure Tester with 2 Gauges



- Kit covers of most domestic and imported cars and light trucks

OTC-5610 **\$169⁸⁵**
Transmission/Engine Oil Pressure Kit



- Can be used for domestic and import applications
- Designed to be used for both static and on road testing
- Kit includes 13 adapters for most applications
- High pressure gauge reads 0-400 psi and 0-2800 kPa
- Low pressure gauge reads 0-100 psi and 0-700 kPa

ATD-5657 **\$64³⁵**
Deluxe Vacuum and Fuel Pump Tester



Manufactured By
LANG TOOLS



- For all domestic and imported cars & trucks with gasoline engines
- Ranges: from 0-10 psi, 0-0.7kg/cm² pressure and 0-28inHg/0-70cmHg vacuum

Turbo System Leakage Testers

CTA-7912 **\$444⁴⁵**
Turbo System Air Leak Test Kit



- Comes with 6 pairs of stepped adapters to fit most size hoses
- Can also be used on cooling system hoses

LIS-69910 **\$490⁸⁵**
14-Pc Car and Light Truck Turbo Air System Leak Test Kit with Smoke Machine Adapter



- For most turbo systems on cars and light trucks. Can also be used on some cooling system hoses.

LIS-69930 **\$454⁰⁵**
10-Pc Heavy-Duty Vehicle Turbo Air System Leak Test Kit with Smoke Machine Adapter



- For most turbo systems on light duty trucks and Class 7 & 8 Semis
- Can also be used on some cooling system hoses.

Combustion Leak Detectors

LIS-75500 **\$62²⁵**
Combustion Leak Detector



- Detects bad head gaskets, cracked blocks, & cracked or warped heads

UVW-560000 **\$119⁴⁵**
Combustion Leak Tester Kit



- Works on gasoline and diesel engines
- A fast, and accurate method to test for combustion gas leaks from: Head gasket leaks, Cylinder head leaks, Engine block leaks
- Includes tester fluid (16 oz/480 ml)

UVW-560500 **\$17⁴⁵**
Replacement Combustion Leak Tester Fluid



- (16 oz/480 ml)

Dyes (Multi-Purpose)



483208



B483206



Multi-Purpose Fluorescent Dye

- Pinpoint leaks in engine oil, transmission, hydraulic, power steering, gasoline, and diesel fuel systems

Item #	Unit Size	Max. Applications	Qty	
UVW-483208	8 oz/240 ml	8 vehicles	1	\$59.05
UVW-B483206	1 oz/30 ml	6 vehicles	6	\$50.05

HBF-TP3400-1P6 **\$42⁷⁵**
OEM-Grade Fluid Dye For All Circulating Oil-Based Systems



- **Applications:** engine oil (gasoline + diesel), power steering, automatic transmission, fuel (gasoline + diesel), hydraulics (not for use in brake systems)
- (6) 1 oz (30 ml) bottles, services up to 6 vehicles

Universal Fluid Dye For Oil-Based Systems



- Finds leaks in oil, fuel, ATF and power steering systems (not for use in brake systems)

Item #	Qty of Bottles	Services (Up To)	
LKF-LF2001CS	1 x 1 oz/30ml	1 Vehicle	\$11.55
LKF-LF2001	6 x 1 oz/30ml	6 Vehicles	\$41.45



LF2001

Spark Plug & Glow Plug Tools



MUK-651 001 **\$22²⁵**

Spark and Glow Plug Starter

- For hard to reach spark and glow plugs
- Flexible rubber tool with special anti-slip textured surface
- Useful tool to install the first pitch of common rail glow plugs



OTC-6900 **\$46⁷⁵**

3/8" Drive Ford F-150 Spark Plug Socket

- 9/16" socket works on 2004+Ford F-150 pickup trucks with 5.4L 3-valve Triton V-8 engines
- Soft rubber insert holds and protects spark plug



VIM-SPM100 **\$228⁷⁵**

13-Pc Master Spark Plug Socket Set

- Extra deep: 9/16", 5/8" & 13/16"
- Universal joint: 14mm, 9/16", 5/8" & 13/16"
- Standard: 14mm, 9/16", 5/8" & 13/16"
- Thin wall: 14mm & 16mm



LIS-63070 **\$34²⁵**

3/8" Drive 16mm, 12 Pt. Thin Wall Magnetic Spark Plug Socket with Swivel

- Applications: BMW, Chrysler, Dodge, Jeep, Honda, Acura, Mercedes, and Mini



CTA-5061 **\$182⁴⁵**

5-Pc Spark Plug Socket Set

- Services wide range of domestic, import & Asian vehicles
- Includes extra-long 10" sockets
- All sockets magnetic except #2376 - 14mm x 12 Pt.
- Includes: #1730 - 5/8" x 12 Pt.; #2380 - 5/8" x 6 Pt.; #2390 - 9/16" x 6 Pt.; #2394 - 14mm x 6 Pt.; #2376 - 14mm x 12 Pt.



GWR-80601 **\$129⁰⁵**

5-Pc 3/8" Drive 6 Point Magnetic Swivel Spark Plug Socket Set

- 9/16" x 6", 5/8" (16mm) x 6", 5/8" x 4", 5/8" x 6", 5/8" x 11"



Spark Plug Sockets

- All sockets magnetic except #2376

Item #	Size x Points	OAL	Applications	
CTA-1730	5/8" x 12 Pt.	6"	Jeep, Dodge, Chrysler, Mitsubishi	\$40.75
CTA-2380	5/8" x 6 Pt.	10"	Dodge Ram 1500 4.7L, Honda, Toyota	\$44.65
CTA-2390	9/16" x 6 Pt.	10"	Ford Triton V8 & V10	\$40.75
CTA-2394	14mm x 6 Pt.	10"	Toyota/Lexus/Scion 1.8L, Nissan, Land Rover, Jaguar & more	\$42.05
CTA-1180	14mm x 12 Pt.	2.5"	BMW, MINI, Mercedes, Porsche, Ford, Nissan, Infiniti, Toyota, Scion, Subaru, & more	\$25.45
CTA-2376	14mm x 12 Pt. Non-Magnetic	2.5"	BMW 2007+, Benz, Ford, Mini 2007-2015, Pathfinder 2015, Prius 2012-2014, Porsche, Scion FR-S 2013, Subaru	\$12.75



AST-94404 **\$100⁷⁵**

4-Pc 3/8" Dr. 6 Pt. Magnetic Spark Plug Extension Socket Set with Universal Swivel

- 9/16" x 6", 5/8" (16mm) x 6", 5/8" (16mm) x 10", 13/16" x 6"



LIS-65200 **\$189⁰⁵**

Deep Hole Aluminum Head M14x 1.25 Spark Plug Hole Repair Kit



ATD-5410 **\$563⁴⁵**

Ford Triton Spark Plug Thread Repair Kit

- For use on 3-valve 4.6L, 5.4L and 6.8L engines found in many 2004-2008 Ford, Lincoln and Mercury
- Repairs damaged spark plug threads or spark plug blowouts in 30 minutes or less per cylinder



14mm x 6 Point Magnetic Spark Plug Socket

- Works on Honda, Infiniti, Lexus, Nissan, Toyota and more



14mm x 12 Point Magnetic Spark Plug Socket

- Works on BMW, Mini, Subaru, Scion, Toyota Prius and more

Spark Plug & Glow Plug Tools



CTA-2340 **\$29³⁵** 14mm Spark Plug Cylinder Head Rethreader Kit

- Repairs damaged threads on aluminum heads
- 5/8" hex drive slim design tap
- Includes (4) solid steel inserts to replace damaged threads: 3/8", 7/16", 1/2", 3/4"



CTA-98141 **\$68²⁵** 14mm Spark Plug Repair kit for Tapered & Gasket Seat Ports

- Repairs 14mm tapered seat & gasketed spark plug ports in aluminum & cast iron heads without drilling
- Includes (3) solid steel inserts to replace damaged threads: 1/4", 3/8", 5/8"



Spark Plug Repair Kit - Non-Tapered Seat

Item #	Size	Inserts (OAL)	
CTA-38109	M10-1	(5) 1/2" and (5) 3/4"	\$79.05
CTA-38129	M12-1.25	(2) 1/2" and (2) 3/4"	\$79.05
CTA-38149	M14-1.25	(2) each of: 3/8", 1/2", 3/4"	\$79.05



LIS-65700 **\$192⁸⁵** Broken Spark Plug Remover Kit for Ford Triton 3 Valve Engines

- Includes the popular broken plug tip remover plus porcelain puller and pusher tools



LIS-65600 **\$148⁶⁵** Broken Spark Plug Remover for Ford Triton 3 Valve Engines

- This tool set removes broken spark plugs from 2004 to 2008 Triton 3 valve per cylinder engines



Glow Plug Drill Kit

- Removes broken glow plugs effectively and safely

Item #	Size	
MUK-600 248	M8 x 1	\$647.55
MUK-600 240	M10 x 1	\$647.55
MUK-600 245	M10 x 1.25	\$647.55
MUK-600 242	M12 x 1.25	\$647.55

CTA-7804 **\$932¹⁵** Glow Plug Puller Kit

- Removes glow plugs, even when compartment is not easily accessible
- Enables removal of glow plugs in the top of the cylinder head without damage



CTA-7802 **\$672⁸⁵** Glow Plug Tip Puller Kit

- Removes broken glow plug tips stuck in cylinder head
- Kit services limited clearances, enabling its use for firewall sided glow plugs



CTA-7730 **\$611¹⁵** Glow Plug Rethreader Set

- Repairs glow plug threads for a wide range of diesel engines
- Kit includes self-guided reamers and taps with no need for glue or thread seal
- 4 of each thread repair inserts: M8 x 1.00 (Short), M8 x 1.00 (Long), M9 x 1.00, M10 x 1.00, & M10 x 1.25



CTA-7392 **\$191³⁵** 6-Pc Spark Plug & Glow Plug Socket Set

- For removal and installation of Spark Plugs, Glow Plugs & Pressure Sensor Glow (PSG) Plugs
- 15-20° swivel range for access in tight fitting applications
- Includes 5 plug protectors
- Sizes: 8mm x 6-Pt., 9mm x 6-Pt., 10mm x 6-Pt., 12mm x 6-Pt., 14mm x 12-Pt. & 16mm x 6-Pt.



Spark Plug & Glow Plug Tools

GW GEARWRENCH

GWR-161D **\$16⁰⁵**

Deluxe Feeler Gauge, 32 Blades

- Measures clearances from 0.0015" to 0.035" (0.038mm to 0.889mm)
- Blade size: 3-5/16" x 1/2"
- 0.010" brass blade for electronic ignitions



GWR-3293D **\$5⁹⁵**

Spark Plug Gap Gauge

- Measures from 0.020" to 0.100" (0.635mm to 1.143mm)



GW GEARWRENCH

LANG

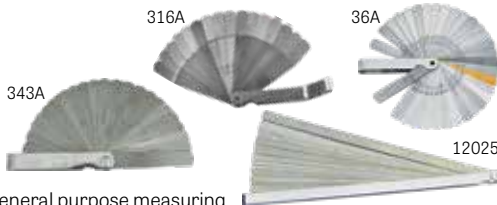

Feeler Gauges

- For ignition and general purpose measuring

Item #	Description	Blade Size	Size Range	
LAN-316A	16-Blade 45° Offset Valve Tappet Feeler Gauge	4" x 1/2"	.005 to .020	\$11.05
LAN-343A	25-Blade Metric Feeler Gauge	4" x 1/2"	.04 to 1mm	\$15.35
LAN-36A	32-Blade Feeler Gauge – One brass blade for transistorized engines	3" x 1/2"	.0015 to .035	\$15.45
LAN-12025	25-Blade Feeler Gauge	12" x 1/2"	.0015 to .040	\$53.05

Spark Testers

LIS-20700 **\$35⁵⁵**

Coil-On-Plug Spark Tester

- Applications include Ford, Chrysler, Mitsubishi, Nissan and more



In-Line Ignition Spark Checker

TOOL AID
PROFESSIONAL AUTOMOTIVE TOOLS

Item #	Boot	
SGT-23900	Straight	\$15.55
SGT-23920	90°	\$17.95



SGT-23970 **\$38⁸⁵**

In-Line Spark Checker Kit for Recessed Plugs

- Can also be used to test conventional and coil-on plug ignition systems



Specialty Tools

ATA

Piston Ring Compressors

	CTA-4021	CTA-4023
Application	Passenger Cars	Cars/Light Trucks
Depth	3" (75mm)	4" (100mm)
Range	60mm - 175mm	53mm - 175mm
	\$19.15	\$20.35



CTA-5414 **\$178⁶⁵**

4-Pc Master Broken Dipstick Tube Extractor Kit for Ford, Dodge, GM



GW GEARWRENCH

GWR-124DD **\$25⁶⁵**

Remote Control Starter Switch

- Use to bypass the ignition switch on any engine with a solenoid starter switch



CTA-7637 **\$102⁰⁵**

Chrysler Rocker Arm Remover & Installer

- Services 1999-2013 Jeep, Dodge, Chrysler with 3.6L & 4.7L engines
- Services DR, DS, HB, HG, KA, KJ, KK, ND, WK & XK systems

ATA



Central TOOLS, INC.

GEN-6434 **\$388⁴⁵**

Engine Cylinder Sleeve Height and Counterbore Gauge

- Pointed contact for sleeve height
- Flat contact for counterbore



ATA

CTA-7639 **\$89²⁵**

Valve Spring Compressor for Ford 4.6L, 5.4L & 6.8L 3-Valve Engines



OTC-4572 **\$127⁰⁵**

Large Valve Spring Compressor

- For use on overhead valve engines
- Includes two valve spring adapters, which fit valve spring retainers up to 1" (25 mm) and 1-3/16" (30 mm)

OTC



Sensor Sockets

LOC-994 **\$259⁷⁵**

Shockit™ Socket O2 Sensor Removal Kit

- Air hammer powered Shockit™ Sockets to access, loosen, and remove frozen and obstructed O2 sensors
- Works when ratchets, wrenches, and sockets don't fit
- Angled punch for limited access applications
- Removes NOx sensors on Kenworth, Cummins, International, Detroit, and Volvo diesel truck engines



LOC-996D **\$578¹⁵**

Shockit™ Socket Diesel NOx & Particulate Sensor Removal Kit

- Air hammer sockets for removing diesel exhaust sensors
- 22mm sockets for removing NOx sensors on Chevy Duramax, Dodge Cummins, Ford Power Stroke, Kenworth, Cummins, International, Detroit, Volvo, Jeep and RAM ECO Diesel
- 24mm sockets for removing Particulate Sensors (Soot Sensors) on Chevy Duramax, Dodge Cummins, and Ford Power Stroke
- 30mm socket removes the NOx sensors lock nuts on Jeep and Ram ECO Diesel
- Includes 20mm, 22mm, & 27mm bottoming tap and dies for sensor and mounting hole threads



TBQ-11332 **\$55⁵⁵**

7-Pc Sensor and Sending Unit Socket Set

- A variety of sockets to replace O2 sensors, oil pressure switches, oil sender units, vacuum switches and thermal sensor switches



AST-7801 **\$106¹⁵**

7-Pc Sensor and Sending Unit Socket Set



OTC-4673 **\$143¹⁵**

7-Pc Oxygen Sensor Socket Set



ATD-5666 **\$197⁰⁵**

11-Pc Oxygen Sensor & Sending Unit Socket Set

- Variety of sizes and styles for use on most domestic and imported vehicles
- Includes oxygen sensor thread chaser
- Comes in a blow molded case



CTA-2064 **\$25⁴⁵**

3.5" Long Thin-Wall Oxygen Sensor Socket

- Removes and installs 22mm oxygen sensors that cannot be accessed with standard sockets
- 1/2" square drive & 1" Hex drive



CTA-2073 **\$73⁹⁵**

3-Pc Oxygen Sensor Socket Set - 7/8" (22mm)



LIS-12100 **\$25⁹⁵**

7/8" Oxygen Sensor Socket

- Removes and installs oxygen sensors on most domestic and some imports



LIS-12230 **\$8³⁵**

Oxygen Sensor Thread Chaser

- Size: M18x1.5
- Also works on M18x1.5 spark plug thread



LIS-12180 **\$15²⁵**

Soot Sensor Thread Chaser

- Size: M22 x 1.5
- Cleans threads in soot sensor holes



LIS-12290 **\$68⁵⁵**

NOx & Soot Sensor Socket Set

- For easy access on NOx and Soot Sensors
- Includes 24mm & 30mm offset 1/2" drive sockets, 6 and 12 pt.
- Works on 2014+ Ram 3.0L EcoDiesel V6 engines found in Jeep Grand Cherokee and Dodge Ram 1500 Trucks



LIS-12030 **\$267⁴⁵**

10-Pc Sensor Socket Set

- Allows access to difficult wired temperature sensors, thermo switches and other components
- Works on ABS, master cylinder, coolant, and diesel injection sensors
- Includes 10mm-19mm, 3/8" drive sockets



CTA-5083 **\$140³⁵**

6-Pc 3/8" Drive EGT Sensor Socket Set

- Install and remove EGT (Exhaust Gas Temperature) sensors on cars and trucks
- 13mm, 14mm & 17mm straight and offset sockets



Timing Belt / Timing Chain Tools

MASTER KIT



CTA-2857L **\$102⁰⁵**

5-Pc Master Cam Locking Kit

- Holds camshafts in position during timing belt replacement
- Services many makes, including Fiat, Ford, Honda, Hyundai, Mazda, Mitsubishi, Nissan, Saab, Subaru, Toyota, Volvo, etc.
- Works on a wide variety of Single Cam, Dual Cam & Quad Cam Overhead engines

CHRYSLER



CTA-5000 **\$262⁷⁵**

Chrysler Cam Timing Locking Set

- For 3.0L, 3.2L & 3.6L Pentastar engines
- Applications: 2011 and newer Chrysler, Dodge and Jeep models
- Comparable to factory tools #10202, #10200A and #10369A

CHRYSLER



CTA-1205 **\$487⁶⁵**

Cam Phaser & Timing Chain Locking/Holding Set for 3.6L Pentastar Engines

- Services 2016+ Chrysler, Dodge & Jeep models
- Comparable to factory tools #10202, #10200A, #2025001090 and #2025002090

FORD/MAZDA



CTA-2223 **\$35⁶⁵**

3-Pc Ford Timing Wedges - 1.4L & 1.6L

- Designed to hold/wedge while performing timing service
- Use on Sigma platform engines, 1.4L & 1.6L Duratec 16V engines from 2000 and up models • Example applications are the Ford Fiesta, Focus, Puma, C-MAX, Fusion (Mondeo) and Mazda 2

FORD/MAZDA



CTA-5067 **\$89²⁵**

Ford EcoBoost Timing Tool Kit - 2.0L & 2.3L

- Set includes: TDC Crank Timing Pin, Camshaft Alignment Tool, and Crankshaft Positioning Tool
- Applications: Edge, Escape, Explorer, Focus, Mustang, Fusion, Taurus, XF, Evoque, MKC, MKT & MKZ
- Comparable to factory tools #303-507, #303-1521 and #303-1565

FORD/MAZDA



CTA-2880 **\$50⁹⁵**

Ford/Mazda Camshaft Timing Kit - 1.4L, 1.5L, 1.6L & 2.0L

- For locking and positioning camshafts, crankshafts & injection pump sprockets when replacing timing belts or chains
- Services Mazda and Ford including all HWDA, HWDB, & HXDA engines

FORD/MAZDA



CTA-1090 **\$50⁹⁵**

Ford VCT (Variable Camshaft Timing) Alignment Tool - 1.6L

- Services 2011-2014 Fiesta, 2013-2014 Escape, Fusion and Transit
- Can be used with CTA #2880
- Compare to Ford Factory Tool: #303-1097

FORD/MAZDA



CTA-2221 **\$356⁶⁵**

Ford/Mazda Master Timing Kit

- Services Ford, Mazda & Lincoln 1.4L, 1.5L, 1.6L, 2.0L, 2.3L, 2.5L, 3.0L & 3.5L engines; variations of the EcoBoost, Duratec Flex Fuel & GTDI engine models from mid-90's through today

FORD



CTA-2743 **\$204¹⁵**

Ford 1.6L EcoBoost Engine Service Kit - 1.5L & 1.6L

- **Ford Cam Locking Plate - 1.5L & 1.6L** (Comparable to Ford factory tool #303-1552)
- **Ford Flywheel Holder - 1.6L** (Comparable to Ford factory tool #303-393A, 303-393-01 & 303-393-02)
- **Ford Crankshaft Vibration Dampener Alignment Tool - 1.6L** (Comparable to Ford factory tool #303-1550)
- **Ford Fuel Line Disconnect Tool - 5/16" x 3/8"** (Comparable to Ford factory tool #310-250)

FORD



LIS-37230 **\$122⁹⁵**

Timing Tool for Ford Turbo - 3.5L

- For use when servicing the timing chain on 2017 and newer Ford V6 3.5L turbo engines



LIS-37200 **\$104⁷⁵**

Timing Tool for Ford with Tensioner - 3.5L & 3.7L

- Applications: 3.5L - 2007 to 2016, non-turbo 2017; 3.7L - 2009+

Timing Belt / Timing Chain Tools

GM / Chevrolet 

CTA-1046 **\$412⁸⁵**

GM Ecotec Timing Kit - 1.4L

- Sets timing on 2011+ GM models with the 1.4L Ecotec engine
- Comparable to GM factory tools: #EN-49977-100, #EN-49977-200, #EN-49978, #KM-952, #KM-953-A and #KM-955



MINI 

CTA-5410 **\$300³⁵**

N13/N16 & N18 Mini Cooper Timing Tool Kit

- Applications: Cooper, Countryman, Paceman
- Comparable to MINI factory tools: #117440, #119590 & #119340



GM / Chevrolet  **AST ASSEMBLY SPECIALTY TOOLS**

ASM-GM140 **\$388³⁵**

GM Ecotec Timing Kit - 1.4L

- Used to set the timing on the 2011+ GM with the 1.4L Ecotec Turbo Engine
- Comparable factory tools: #EN-49977-100, #EN-49977-200, #EN-49978, #KM-953-A, #KM-952 and #KM-955



VW / AUDI 

CTA-2777 **\$84¹⁵**

VW/Audi Timing Tool Kit - 1.9L & 2.0L

- For VAG 1.9L & 2.0L TDI PD DOHC engines found on Audi A4, A6, VW Golf, Jetta and Touareg models

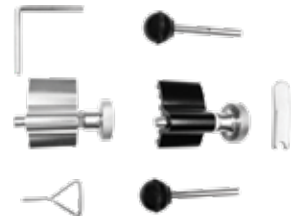

GM / Chevrolet 

CTA-4161 **\$109⁷⁵**

Chevrolet Camshaft Locking Tool Kit - 1.6L & 1.8L

- Locks the camshafts in position and ensures proper alignment
- Services GM 1.6 & 1.8L engines
- Also services 1.6 & 1.8L 16V Alfa Romeo and Fiat 2003-2012

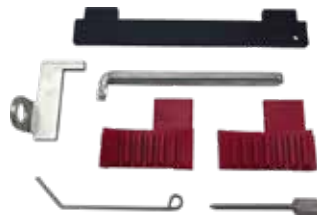

VW / AUDI 

CTA-2889 **\$387⁹⁵**

VW/Audi 2.0L Turbo Timing Kit (TFSI)

- All the tools needed to service 2009+ turbo models

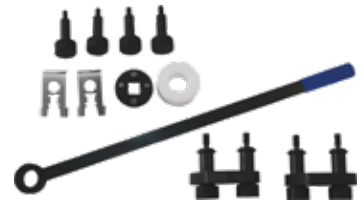

GM / Chevrolet 

LIS-37530 **\$68⁵⁵**

4-Pc Timing Tool Kit for GM

- For use when servicing the timing chain on GM 2.8L, 2.9L, 3.0L, 3.5L, 3.6L, 3.7L, and 4.2L engines



HONDA / ACURA 

LIS-37950 **\$25⁷⁵**

Camshaft Lock Tool for Honda/Acura K-Series Engines

- Works on K20 and K24 engines including: Civic, Accord/Integra, CRV/RXS, Odyssey and Element



GM / Chevrolet 

OTC-6691 **\$110⁷⁵**

GM Camshaft Retaining Tool - 2.8L, 3.0L & 3.6L

- Lock camshafts together at top dead center (TDC) on GM 2.8L 3.0L and 3.6L DOHC engines



CTA-7541 **\$21⁰⁵** 

10mm Subaru Hex Bit Socket for Cam Sprocket Bolts

- 1" Hex with internal 10mm Hex designed to securely fit Subaru hollow cam sprocket bolts
- For model years from approximately 2002-present
- Impact-rated



MINI 

CTA-3770 **\$456⁷⁵**

BMW/MINI Timing Chain Tool Kit - N12, N14 & N16

- Services: N12, N14 & N16 engines in R55-R61 models 2007-2016 (Cooper, Paceman & Countryman)
- Compare to MINI/BMW factory tool #'s: 119551, 119552, 119553, 119590, and 119340





LIS-18000 **\$404³⁵**

Universal Camshaft Bearing Driver Set

- Low cost set that will remove or insert camshaft bearings in nearly all engines from compact cars to heavy trucks
- Range of 1.125" to 2.69"



Heavy-Duty Truck Diesel Engine Tools



ASM-CM369 **\$192⁷⁵**

Cummins ISX Gear Puller

- Used to pull the injector and valve cam gears on Cummins ISX engines, 2007-2016
- Comparable to factory Cummins #3163069



ASM-CM3021 **\$594⁸⁵**

Cummins ISX 4 Wedge Timing Set

- Used for setting the gear train timing on all Cummins ISX engines, 2007-2016
- Comparable to factory Cummins #3163021



ASM-DD463 **\$184⁸⁵**

Engine Barring Tool for Detroit Diesel Engines

- Used for turning engines to TDC (top dead center)
- Applicable to Detroit Diesel DD13, DD15 & DD16 heavy-duty diesel engines (EPA07-GHG17)
- Comparable to Detroit Diesel tool #W904589046300



ASM-PAC13 **\$115¹⁵**

Engine Barring Socket for Paccar MX-13 Engines

- Used for turning engine to TDC (top dead center)
- Comparable to Paccar #1903018 and #1453158PE



LIS-61840 **\$72³⁵**

Engine Barring Tool for Paccar MX-13 Engines

- Allows the engine crank to be manually adjusted
- Can be used to make sure the engine rotates freely while troubleshooting other issues



OTC-7471A **\$132²⁵**

Cummins Engine Barring Tool

- Works on Cummins B and C series diesel engines and 5.9L liter diesels used in Dodge pickups



OTC-6749 **\$130⁸⁵**

Engine Barring Socket

- Designed to rotate engine on a Mack E7 and Cat 3208
- Similar to J-38587-A



SLY-95650A **\$73⁸⁵**

Cummins Engine Barring Tool with Variable Depth

- For use on 1987 and newer Cummins B, C & L series engines, J.I. Case 3.9L, 5.9L, 6.7L, 8.3L diesel engines and most of the popular Dodge diesel pickup trucks



LIS-22130 **\$69⁷⁵**

36mm 12 Pt. Barring Wrench for Duramax

- 22.5" long wrench works on 2001 and newer Duramax engines to turn the crankshaft allowing access to the torque converter bolts



OTC-6492-10 **\$209³⁵**

Oil Priming Adapter

- Allows for proper engine pre-lubing, preventing dry starts after engine service
- **Application:** Detroit Diesel DD13 and DD15 engines
- **Similar to:** J-49181



OTC-5881 **\$336⁴⁵**

Cam Gear Alignment Fixture

- This tool pulls the cam drive gear hub and thrust plate forward for camshaft and/or thrust plate seal removal and installation
- **Application:** Detroit Diesel Series 60
- **Similar to:** J-35906 and J-35906-6A



OTC-5882 **\$299⁰⁵**

Cam Gear Alignment Tool

- Properly aligns the cam gear during camshaft assembly installation
- **Application:** Detroit Diesel S60
- **Similar to:** J-45946



OTC-5884 **\$172²⁵**

Cam Gear Retaining Tool

- Holds cam gear during cam gear bolt removal and installation
- **Application:** Detroit Diesel S60
- **Similar to:** J-35652-B



Heavy-Duty Truck Diesel Engine Tools

OTC-5887 **\$688⁰⁵**

Crankshaft Seal and Wear Sleeve Installer

- Properly installs the front and rear crankshaft wear sleeves and seals
- **Applications:** Detroit Diesel Series 60 and two cycle 92 engines
- **Similar to:** J-35686-B



CTA-3895 **\$471²⁵**

ISX Rear Crankshaft Main Seal and Wear Sleeve Remover/Installer Set

- **Applications:** newest Cummins seals on ISX, QSX, ISX15 and ISX12 engines
- Comparable to Cummins factory tool #3164780 (seal/sleeve kit #4965569)



CTA-7320 **\$1203⁵⁵**

4-Pc Master Front & Rear Crankshaft Seal Remover/Installer Set for Ford 6.7L Powerstroke

- Services Ford Super Duty F-250, F-350, F-450, F-550, F-650 & F750 from 2011-2019 (Also services some 2020+ models)
- Comparable to Ford factory tool #303-1509, #303-1514, #303-1510 & #303-1513



OTC-5883 **\$80¹⁵**

Crankshaft Alignment Tool

- Places No. 1 cylinder at TDC (top dead center) during camshaft timing inspection and service. Ensures crankshaft is aligned properly.
- **Application:** Detroit Diesel S60
- **Similar to:** J-45947



ASI **ASSEM-MACHER SPECIALTY TOOLS**

ASM-HTLP100 **\$1700³⁵**

Universal Cylinder Liner Puller

- Used to remove the cylinder liners on Caterpillar, Cummins, Detroit Diesel, Mercedes OM460 and Volvo D13 engines

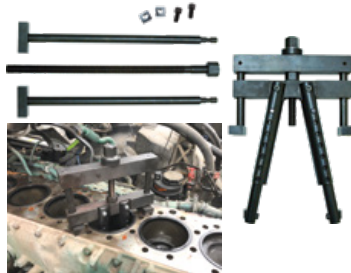

OTC-5875 **\$2299¹⁵**

Cylinder Liner Remover

- Expands in the cylinder to pull liners from 5.0" to 5.75" inner diameter
- **Application:** Detroit Diesel S60 12.7L with EGR; MTU S2000
- **Similar to:** J-45876

OTC-5874 **\$423⁸⁵**

Cylinder Liner Installer

- Drive screw and plate forces cylinder liner into correct position. Attaches to engine with three cylinder head bolts.
- **Application:** Detroit Diesel S60
- **Similar to:** J-35597-A



OTC-4853 **\$30⁵⁵**

Universal Piston Ring Compressor

- Fits most piston rings
- Adjustable from 2.125" to 5.0" piston rings
- **Application:** All
- **Similar to:** J-8037



CTA-4024 **\$31⁸⁵**

Piston Ring Compressor

- **Application:** Tractors/Diesel Trucks
- Depth: 6" (150mm)
- Range: 60 - 175mm

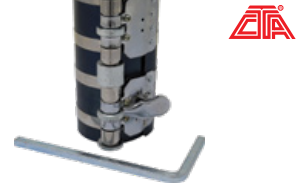

ASI **ASSEM-MACHER SPECIALTY TOOLS**

3/8" Drive 12 Pt. Bypass Wrench for Heavy-Duty Trucks

- Used to assist in removal and re-installation of Turbo nuts and bolts

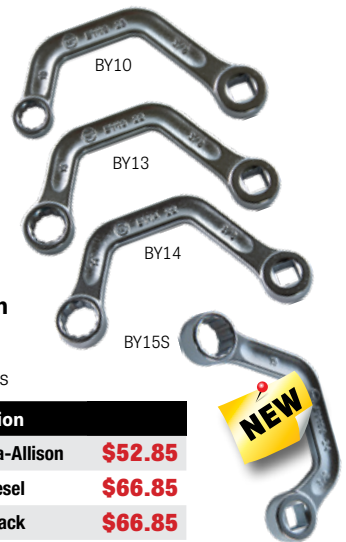

Item #	Size	Application	
ASM-BY10	10mm	CASE & Chelsea-Allison	\$52.85
ASM-BY13	13mm	Detroit Diesel	\$66.85
ASM-BY14	14mm	Volvo & Mack	\$66.85
ASM-BY15S	15mm	Cummins 5.9, 8.9, X15	\$61.55

CTA-7250 **\$54⁸⁵**

Fluid Service Tools for 6.7L Cummins Diesel Engine

- Services 2013+ Dodge RAM 6.7L Cummins Diesel 2500/3500 HD trucks
- Includes: oil filter plug, 28mm fuel filter socket, and Cummins & Duramax 42mm water sensor wrench



CTA-8612 **\$165⁸⁵**

Cummins Sleeve Installer Kit - 3.9L, 5.9L & 6.7L

- Services Paccar PX-6, 1989-2016 Cummins 4BT 3.9L, B Series 5.9L, ISB 5.9L 6.7L and QSB 5.9L 6.7L
- Installs factory seals 3937111, 3904353, 3802820



CTA-3877 **\$159⁵⁵**

Damper/Crank Oil Seal Installer - 7.3L Powerstroke & T444E

- Installs both the front seal and the damper
- Use the screw to gradually and smoothly install instead of using a hammer, preventing damage to all components
- Comparable to Ford factory tool #303-484



Diesel Injector Service Tools

\$508⁷⁵ **OTC**

OTC-6770

Ford 6.0L Diesel Service Tool Kit

- Properly test vehicle systems for leaks & blockage
- Safely remove and re-install harnesses without damage
- Fuel filter cap wrench, glow plug and injector harness release tools
- Oil line disconnect tool, EGR removal tool
- IPR controller, IPR socket tool and fuel rail pressure adapters



CTA-3875 **\$734⁶⁵**

Ford Fuel Injector Sleeve Cup Remover/Installer Tool - 7.3L

- Services F-250, F-350, F-450 & F-550 Super Duty 7.3L engines
- Comparable to Ford factory tools #303-DS105 D94T-9000-B and #303-D109 D94T-9000-C



OTC-4200



Diesel Injector Nozzle Tester

- The ultimate tool for diagnosing a number of problems that affect diesel fuel injector nozzles
- Enables you to check for leakage, pop-off pressure, spray pattern, and chatter
- This tool will accommodate a wide range of injectors. Not designed for Cummins or Detroit injectors.
- Optional adapters available to troubleshoot nozzles used in popular automotive, agricultural, and construction engines



OTC

CTA-3876 **\$169⁷⁵**

Fuel Injector Remover - Ford 6.7L Powerstroke

- Services 2011-2021 Ford F-250, F-350, F-450, F-550 & Super Duty
- Comparable to Ford factory tool #310-230



ATA



CTA-7810 **\$178⁶⁵**

Injector Seat & Chamber Cleaning Set

- Cleans injector seat and hole prior to installing new injector



MUK-600 130 **\$906⁷⁵**

Universal Diesel Injector Puller Kit

- Fits Bosch, Delphi, Denso, Siemens
- Works most often without removing the electric plug



SLY-17600 **\$376⁷⁵**

Sprinter Van 2.7L Injector Puller Kit

- Works on:
 - Dodge Sprinter 2003-2009, 2.7L 2500 and 3500
 - Freightliner Sprinter 2002-2007, 2.7L 2500 and 3500
- Removes stuck injectors in minutes instead of hours without damaging the injector or valve cover



JD TOOLS



CTA-7468 **\$185⁰⁵**

4-Pc 1/2" Drive 12-Point Injection Line Wrench Set

- 14mm, 17mm, 19mm, 22mm



SLY-17200 **\$181⁷⁵**

Dodge Cummins 5.9L & 6.7L HPCR Injector Puller Kit

- Works on 2003 to current model Cummins ISBE HPCR engines
- Pulls the injector straight and completely out



JD TOOLS

CTA-3873 **\$450⁶⁵**

Ford Fuel Injector Sleeve Cup Remover/Installer Tool - 4.5L & 6.0L

- Services VT275 24 Valve, VT365 32 Valve, 2006-2009 6.0L Powerstroke Diesel, and 2004-2010 4.5L Diesel, including Low Cab Forward E-Series, F-250, F-350, F-450, F-550, F-650, F-750 Super Duty Excursion
- Comparable to Ford factory tools #303-767 & #303-768



ATA

SLY-16300 **\$255⁰⁵**

Diesel Injector Puller - Ford 6.7L Powerstroke

- 2011 to current
- Pulls the injector straight out of the head reducing damage to the head & injector



CTA-3874 **\$425⁹⁵**

Ford Fuel Injector Sleeve Cup Remover/Installer Tool - 6.4L

- Services 2008-2010 Ford 6.4L Powerstroke Diesel on F-250, F-350, F-450 & F-550. Also services 2008-2010 Maxforce 7.
- Comparable to Ford factory tools #3303-1262 & #303-1263



OTC-6778 **\$141³⁵**

GM Duramax Injector Puller

- Application: 2001-2004 6.6L Duramax engines
- Similar to: J-44639



OTC

OTC-6777 **\$185⁰⁵**

GM Duramax Injector Puller

- Application: 2011+ 6.6L Duramax Diesel, Isuzu engines
- Similar to: Kent-Moore #EN-49774



Diesel Injector Service Tools

SLY-13300 **\$192¹⁵**
**GM Duramax LLY, LBZ, LMM
 Injector Puller Kit**

- Works on Duramax LLY, LBZ, and LMM 2005-2010



Lisle
 LIS-40740 **\$335⁹⁵**
**Cummins and Duramax
 Diesel Injector Puller Kit**

- **Applications:** Duramax 2001- 2010, LB7, LLY, LBZ and LMM. 2011 and newer LML engines. Cummins 2003 to 2018 5.9L and 6.7L.



SLY-11400 **\$103⁴⁵**
**Ford Power Stroke 6.7L
 Diesel Injector Sockets**

- 17mm 12 point flare nut socket and deep crows foot removes various injector lines at any angle



Lisle
 LIS-68210 **\$43⁶⁵**
**Injector Pressure Regulator
 Socket for Ford 6.0L and
 International Diesel Engines**



SLY-14400 **\$150⁷⁵**
**Duramax LML Fuel Pressure
 Release Valve Wrench**

- For 2011 and later Duramax LML engines
- Eliminates the need to remove EGR cooler and fuel rail to access the valve



OTC-5869 **\$603⁵⁵**
Diesel Fuel System Priming Pump

- For all applications
- Pressurizes the fuel system after service
- This tank provides pressurized diesel fuel to bleed the air from the fuel system and allows for immediate proper fuel pressure
- Similar to J-4791



OTC-5869-1 **\$69⁹⁵**
Diesel Fuel System Coupler Fitting

- **Applications:** Detroit Diesel S60, MBE900, MBE4000
- Connects to "compu-check" quick-connect fitting
- **Similar to:** J-47912-QC



OTC-5868 **\$284⁷⁵**
**Detroit Diesel Fuel System
 Test Gauge**

- Used to properly diagnose and repair fuel systems
- **Application:** Detroit Diesel DD13 & DD15 engines
- **Similar to:** J-48876



Lisle
 LIS-10810 **\$130⁶⁵**
**5-Pc Injector Rail
 Fuel Line Cap Set**

- Used to block off the fuel rail during fuel pressure diagnostics in 2003-2022 Cummins, 2001-2022 Duramax, and 2008-2022 Ford engines



OTC-6780 **\$64⁰⁵**
Fuel Pressure Test Adapter



- It allows you to block off the rail one line at a time
- **Application:** 2003+ 5.9L Cummins Diesel
- **Similar to:** Miller MLR-9011

OTC-5870 **\$347⁶⁵**
**Detroit Diesel Injector
 Height Gauge Set**



- Used to properly set injector body height to the injector follower for proper fuel injector timing
- **Application:** Detroit Diesel two cycle 53, two cycle 71, two cycle 92, Series 60, and DDEC IV engines
- **Similar to:** J-35652-B

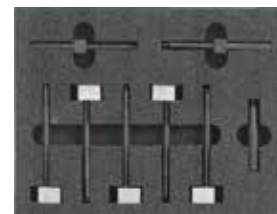

OTC-5877 **\$499⁵⁵**
**Detroit Diesel Injector Cup
 Removal & Installation
 Tool Set**

- Eases removal and installation of screw-in stainless steel injector cups
- **Application:** Detroit Diesel S60, MBE900, MBE4000
- **Similar to:** J-46904 and J-48824



OTC-5886 **\$254⁹⁵**
**Detroit Diesel Fuel Injector
 Torque Adapter**

- Eases removal and installation of injector feed tubes
- Can be used to properly torque injector tubes during installation
- **Application:** Detroit Diesel DD13 and DD15
- **Similar to:** J-48770



OTC-5876 **\$511⁶⁵**
Detroit Diesel Injector Remover

- Removes seated injectors correctly
- **Application:** Detroit Diesel S60
- **Similar to:** J-47372



SLY-16100 **\$110⁸⁵**
**Duramax LB7
 Injector Cup Puller**

- Removes the 2000-2004 LB7 injector cups without damage
- Assists with the re-install
- A must-have tool when re-sealing injector sleeves



Fuel Injector Service Tools

CTA-3871 **\$165⁸⁵**

Ford Fuel Injector Seal Installer

- Services Ford 1.6L, 2.0L, 2.3L, 3.5L, and 3.7 GTDI engines
- Comparable to Ford factory tools #310-207 & #303-1567



CTA-2250 **\$231⁴⁵**

BMW Fuel Injector Oil Seal Remover/Installer Kit

- Services BMW N54 I6 & N63 V8 engines, and MINI N14 & N18 L4 engines
- Comparable to factory tool #83300495756



CTA-7798 **\$178³⁵**

Ford Fuel Injector Puller

- Services: Ford EcoBoost GDI engines (1.0L, 2.0L & 3.5L)
- Commonly used for replacing Injector #CM5G-9F593-FA
- Comparable to Ford factory tool #310-206



Fuel Pump Tools

LOC-940 **\$35⁹⁵**

Gas Tank Fuel Pump Removal Tool

- Universal adjustable design fits and removes most plastic fuel pump retaining rings
- Use to re-install old retaining ring



9CL-41820 **\$132⁷⁵**

Fuel Pump Locking Ring Wrench for Toyota and Lexus

- 3/8" square drive - 19mm Hex
- O.D.: 7" (177mm)
- I.D.: 5.6" (143mm)



Diesel Fuel Hydrometers

OTC-6750 **\$284⁷⁵**

Diesel Fuel Hydrometer

- Tests #1 and #2 grade diesel fuel composition and combustion characteristics



Fuel Tank Tools

LIS-62970 **\$99⁹⁵**

Fuel Tank Lock Ring Removal and Installation Kit

- Fits rings from 4" to 7-1/4"
- Works on the smaller GM serrated rings, and traditional rings
- Works on many 2004+ vehicles including Ford F150, Chevrolet pickups, Chrysler/Dodge mini vans, PT Cruiser, Dakota and Durango



Fuel Line Service Tools



Sly-13400 **\$73⁸⁵**

BMW Injector Line Sockets - 14mm & 17mm 12 Point, 3/8" Dr.

- Applications: N54, N63 and S63 engines 2007-2013
- 3.3L V6 1990 & later



LIS-12320 **\$77⁴⁵**

19mm & 22mm Fuel Line Sockets for Cummins ISB and ISX Engines

- Designed to replace fuel line fittings
- 22mm for the newest ISX Cummins motors
- 19mm for 2011 and older diesel engines



LIS-12090 **\$180³⁵**

5-Pc Fuel Line Socket Set

- Sizes: 17, 19, 21, 22, 24mm
- 17mm: works on Audi A1, A3, A4, A6, A8, VW Passat, BMW N54, N63, S63, and Ford Power Stroke engines
- 19mm: works on 2011 and older diesel engines plus Cummins ISB engines
- 21mm: works on Paccar MX 11 and MX 13 engines
- 22mm: works on the newest ISX Cummins motors
- 24mm: used on NOx and soot sensors



CTA-1809 **\$250²⁵**

5-Pc Fuel Line Flex Sockets

- Provides ability to tighten and loosen nuts on direct fuel line without losing torque
- Sizes: 11, 13, 14, 15, 17mm



ASM-DDF19 **\$80¹⁵**

Detroit Diesel Injector Line Socket - 19mm, 3/8" Drive

- Used to remove and install injector feed tubes on Detroit Diesel DD13 and DD15 engines
- Comparable to #J-48770



ASM-MVW2050F **\$104⁵⁵**

VW/Audi/Mercedes Fuel Filter & Fuel/EVAP Line Pliers

- Used for fuel lines with plastic snap-together connectors found on VW/Audi models and Mercedes (163) M-Class fuel filters
- Applicable to some Fiat, GM and Opel gas engine vehicles
- Works on late model Lexus and Toyota fuel/EVAP lines
- Comparable to Mercedes #163 589 00 37 00



CAL-68800 **\$63⁹⁵**

Adjustable Fuel Line Pliers

- Dual, 180°swiveling jaws and long-reach handles
- Pliers access and release the quick connect fittings found on fuel lines, DEF connectors, and other areas



OTC-6739 **\$101⁹⁵**

Quick Connect Release Tool

- Separates and prevents damage to the 4.8mm (3/16") hydrocarbon injection quick-connector to service the fuel line bundle or replace fuel lines without removing unrelated components
- Application: 2010+ GM 2.8L and 6.6L diesel engines
- Similar to: OE tool #CH-49736



FUEL & DIESEL SYSTEM SERVICE

Fuel Filter Sockets & Wrenches

LIS-61150 **\$29¹⁵** 
Fuel Filter Wrench for the 2014-Current Ram 1500 EcoDiesel

- Wrench is designed with four tabs that line up on the outside of fuel filter housing
- Filter wrench is made of cast aluminum with a 3/8" square drive and 7/8" hex drive



Diesel Fuel Filter Wrenches for Davco

- For removing and replacing the main filter collar as well as the vent cap on Davco aftermarket diesel fuel filter systems

Item #	Capacity	
LIS-61090	5"	\$43.15
LIS-61110	6"	\$46.95
LIS-61130	8"	\$57.05



LIS-61060 **\$38⁰⁵**
Diesel Fuel Filter Wrench for Paccar



LIS-61140 **\$44⁴⁵**
Diesel Fuel Filter Wrench for 3.2L Ford Transit



Compact Diesel Fuel Filter Wrenches for Davco

- Provide 100% engagement on the fuel filter collar



Item #	Size	
LIS-61170	5"	\$48.25
LIS-61180	6"	\$50.75
LIS-61190	8"	\$57.05

LIS-60730 **\$25³⁵**
Diesel Fuel Filter Wrench for AGCO and John Deere

- Wrench loosens the plastic retaining ring on the fuel filter canisters



LIS-61070 **\$20⁷⁵**
Vent Cap Wrench for Davco

- Double ended wrench removes vent cap on top of Davco chassis mounted fuel filter system canisters



LIS-61380 **\$35²⁵**
Compact Diesel Fuel Filter Wrench for Paccar

- Works on fuel filters found on Kenworth, Peterbilt and Cummins



Davco Diesel Fuel Filter Wrenches

- Found on Caterpillar, Cummins, Detroit Diesel, International, Mack, Mercedes-Benz, Volvo and other engines
- Also opens vent cap



Item #	Fits Davco Diesel Filter Models	
OTC-6914	#232, #233, #234	\$56.35
OTC-6915	#382, #384	\$54.85

 Made in USA

Fuel Injection Cleaners

MVC-200-1145 **\$526⁷⁵**

Pressurized Induction Tool

- Can be used to clean induction system through the air intake or through a vacuum line
- Simple, safe depressurization of the system when the service is complete



OTC-7448A **\$460⁰⁵**

Fuel Injection Cleaner Canister

- For direct fuel rail and injection cleaning
- 22 oz. capacity
- Max. 30,000 psi



LAN-TU-470B **\$449⁹⁵**

Fuel Injection Cleaner

- **Right gauge:** reads the vehicle fuel pressure
- **Left gauge:** helps easily set cleaning pressure by referring to vehicle fuel pressure
- Cleans carbon from intake valves, injectors, and combustion chambers with a professional carbon cleaning solution
- Dual scale 2-1/4" gauges: 0-100 psi and 0-7 bar



Fuel System Cleaners/Detergents

MOTORVAC

MVC-400-0020 **\$144⁹⁵**
MotorVac® CarbonClean MV3 Heavy Duty Gasoline Fuel System Cleaning Detergent
 • 12 x 8 oz. (236ml) bottles



MOTORVAC

MVC-400-2225 **\$28⁸⁵**
MotorVac® GDi Induction System & Fuel System Cleaning Kit
 • Includes: #400-2425 and #400-2001



MOTORVAC

MVC-400-2425 **\$15⁰⁵**
MotorVac® GDi Induction System Cleaner
 • Effectively cleans intake valves, combustion chamber, piston crowns, piston ring lands and fuel injector tips
 • 16 fl oz. (473 ml)



Fuel Injection Pressure Testers

ATD-5567 **\$110²⁵**

Basic Fuel Injection Pressure Tester

- 0-100 PSI and 0-7 BAR
- Tests the following systems:
 - American Motors, Bosch AFC, MPC European and Japanese (except CIS)
 - Chrysler; Ford; GM (except TBI)
 - Japanese fuel injection systems and other Bendix-type fuel injection systems
 - Schrader-type valve, including the small valve found on multi-port systems on Ford

LANG
TOOLS



LAN-TU-469 **\$251²⁵**

Fuel Injection Pressure Tester with Schrader Adapters

- Enables testing on all cars with standard or small Schrader valves
- Dual scale 3-1/2" gauge: 0-100 PSI and 0-7 bar



TOOL AID
PROFESSIONAL AUTOMOTIVE TOOLS

SGT-33980 **\$254⁰⁵**

Fuel Injection Pressure Tester with 2 Gauges

- Test gasoline fuel pump pressure on most domestic and imported fuel injection equipped vehicles



OTC-5630 **\$75⁷⁵**

Fuel Pressure Tester Kit

- Locates any malfunctioning fuel system component, including fuel filters, pressure regulators, fuel lines, and fuel pumps without removing it from the vehicle
- Dual scale gauge reads 0-100 psi and 0-700 kPa



OTC-4480 **\$228⁸⁵**

Stinger Basic Fuel Injection Service Kit

- Performs running, residual, rail and flow rate pressure tests
- Kit includes two popular adapters for import vehicles as well as the GM TBI adapter
- Dual scale gauge reads 0-100 PSI and 0-700 kPa
- Comes in a blow molded case

OTC



OTC-6550 **\$875⁷⁵**

Master Fuel Injection Kit

- Test fuel injection systems on most GMs, including GM TBI, Ford, Chrysler, and Jeep vehicles. Also works on imports, including CIS and CISE fuel systems.
- Includes 0-100 PSI fuel pressure gauge and 35 popular OTC fuel injection adapters



ATD-5578 **\$900⁸⁵**

Master Fuel Injection Pressure Test Set for All Systems

- Tests all fuel injection systems both foreign and domestic
- Includes late model GM, Chrysler and European applications
- Large 3-1/2" gauge with dual reading of 0-150 PSI and 0-1000 kPa
- Low pressure 2-1/2" gauge for an accurate reading below 15 PSI



LANG
TOOLS

LAN-TU-443 **\$746⁹⁵**

Deluxe Fuel Injection Pressure Test Set

- Dual scale 3-1/2" gauge: 0-100 PSI and 0-7 bar
- Relief valve and 6 feet of tubing to relieve the pressure and the fuel safely. Also allows checking for sufficient fuel flow.
- The many adapters, hoses, and fittings cover most fuel injection systems worldwide



LANG
TOOLS

LAN-TU-550 **\$880⁶⁵**

Master Global Fuel Injection Test Kit

- Covers all major domestic and foreign platforms 1988 to present (does not include CIS/TBI)
- Accommodates 3/8", 1/4" and 5/16" hose sizes



Fuel System Testers

MIT-MV5545 **\$1337⁶⁵**

Fuel System Test Kit

- Diagnoses and pinpoints common fuel system failures, including failing fuel pump, faulty pressure regulator, blocked filter(s), pinched fuel line, contaminated fuel and fuel tank vortex
- Works with Domestic, European, and Asian cars & light trucks
- Units of measure: GPM and LPM

mityvac



DEF SERVICE & MAINTENANCE



DEF Dispensing Pump Systems

- Compatible with: Water, DEF/AdBlue®
- Automatic nozzle with boot and bracket
- Flow Rate: 8 GPM
- Max. operating pressure: 38 psi
- Duty cycle: 30 min. ON/30 min. OFF
- Inlet/Outlet: 1" BSPP
- 5 ft. suction and 20 ft. discharge hoses with connections

Item #	Voltage	Mounting Type	
FIL-DF120CAN520	120V AC	Cage IBC Bracket	\$1047.25
FIL-DF120DAN520	120V AC	30-55 Gallon Drum Bracket	\$1159.15
FIL-DF012CAN520	12V DC	Cage IBC Bracket	\$1108.75



DF120CAN520



DF120DAN520



DF012CAN520

JDI-JDI-DEF-120V-KT **\$1265⁰⁵**

120V UREA/DEF Transfer Pump Kit

- Automatic delivery nozzle
- Digital meter
- 5 ft. suction hose
- 20 ft. delivery hose
- 40" adjustable suction tube
- Pump mounting rack



PIU-F00332A3A **\$305⁸⁵**

Rotary Hand Pump for the Transfer of DEF, Water & Antifreeze

- Professional performance and is suitable for all 55 gallon drum applications
- Up to 38L (10 gal) per 100 revolutions
- Spout: 3/4"
- 9 ft. delivery hose
- Adjustable suction pipe
- Built-in non-return valve
- Prevents DEF crystallization



FIL-FRHP32V **\$165⁸⁵**

Hand-Operated Lever Transfer Pump

- Designed for hydraulic, engine and gear oils, diesel, anti-freeze, mild acids, DEF, AdBlue and degreasers
- 11 oz per stroke
- Includes 2" NPT bung adapter and 19-3/4" to 35-1/2" telescoping suction pipe



JDI-JDI-DEF-LP **\$59⁷⁵**

DEF Lever Pump

- Also compatible with: water, diesel, biodiesel, kerosene, oil, weak acid and weak alkali
- Anti-corrosion
- Adjustable 36" downtube
- Fits 5 to 55 gallon drums



SGT-17580 **\$204⁸⁵**

Rotary Barrel Pump

- For use with thinners, acetone, DEF (Urea), gasoline, water, weak acids, windshield washer fluid, anti-freeze, diesel, alkalines and petroleum
- Dispenses 8 gallons per 100 revolutions
- Fits 15, 30 & 55 gallon drums with 2" bung opening

LMX-LX-1329 **\$108⁷⁵**

Premium Lever Action Chemical Pump

- For acidic solutions, chemicals, fuels, fuel oils, DEF, Urea, AdBlue®
- Delivers 1 gallon per 8 strokes
- Fits 15-55 gallon drums
- Adjustable locking ring rotates 360°
- Non-drip spout



ATD-5080 **\$191¹⁵**

Plastic Lever Action Barrel Pump

- For use with water-based media, detergents, soaps, antifreeze, windshield washer, hydraulic oils, lubricants, herbicides & pesticides, AdBlue, Urea, DEF
- Delivers 1 pint (500 ml) per stroke
- Fits 15-55 gallon drums
- 6.5 ft. x 3/4" discharge hose
- Built-in 2" bung adapter



ATD-5062 **\$284⁵⁵**

Stainless Steel Vertical Lift Pump

- For use with photographic chemicals/solvents, diesel, kerosene, thinners, acetone, benzene, naphtha, urea, DEF, AdBlue®, light oil (up to SAE 40)
- Flow rate: up to 25 oz. (750 ml) per stroke
- For use with 55 gallon drums
- 2" Bung adapter for use with metal and plastic drums
- Flow control tube
- Built-in lock nut for attaching grounding wires



FIL-FRFA075B **\$282⁹⁵**
3/4" Non-Metallic Automatic DEF Nozzle with Swivel

- Flow rate: 0-8 GPM
- Inlet/Outlet size: 1"



FIL-TT10PN **\$348⁶⁵**
In-Line Digital Turbine Meter

- Compatible with: DEF/AdBlue®, anti-freeze, de-icing fluid, non-potable water, and other chemicals
- Flow rate: 2-35 GPM (8-132 LPM)
- 1" NPT inlet/outlet
- Measures ounces, gallons, liters, quarts, pints



FIL-KITDFH20 **\$94⁶⁵**
DEF EPDM Suction Hose

- 3/4" I.D. x 20 ft. bare end hose



FIL-KITDFFK **\$73²⁵**
DEF Fittings Kit

- (2) 1" BSPP x 3/4" hose barbs strait fittings with retaining nuts
- (2) 1" BSPP x 3/4" hose barb 90-degree elbow fittings with retaining nuts
- (4) stainless steel hose clamps



AS1 **ASSENMACHER SPECIALTY TOOLS**

ASM-MVW2050F **\$104⁵⁵**
Coolant Line Pliers

- Used for removing coolant hoses from DEF control unit on CASE Heavy Equipment 2016-2017



LIS-37140 **\$35⁵⁵**
45° Disconnect Pliers for Fuel Line, EVAP Line & DEF Fittings

- Works on fittings with tabs that must be depressed to disengage
- Works great on Delphi two tab connectors and some import vehicles
- Can also be used on some electrical connectors



LIN-617 **\$86⁰⁵**
1.5-Liter DEF Fluid Extractor/Dispenser



LIS-24210 **\$27⁸⁵**
Spill-Free® DEF Funnel Kit with Adapter for GM

- Translucent funnel with 6" opening
- The adapter holds the funnel in place for safe filling on 2011 to 2019 Duramax vehicles
- Also works on side-fill vehicles

Lisle



THEXTON
 MANUFACTURING COMPANY

TEX-108 **\$30³⁵**
16-1/4" Long Professional DEF Tester

- Tests the urea concentration of diesel exhaust fluid
- Accurate at all temperatures



EZRED

EZR-SP110 **\$17⁶⁵**
DEF Hydrometer

- Quick, accurate, and easy readings of diesel exhaust fluid
- Indicates "GOOD" or "REPLACE"
- Includes an extension hose for longer reach applications



Central
STORM

CEN-3R401 **\$151⁴⁵**
Coolant/DEF/Battery Refractometer

- Easily check status of Coolant, DEF and Battery Fluid



ATD

ATD-3325 **\$168⁶⁵**
Coolant/DEF/Battery Refractometer

- Automatic temperature compensation
- Reads both Ethylene and Propylene Glycol based coolants



MULLER KRUUPS

MUK-727 090 **\$186²⁵**
DEF/Ad-Blue 4-in-1 Refractometer

- Tests the quality of:
- Ad-Blue • Radiator coolant
 - Windshield washer fluid • Battery acid



OTC

OTC-5025 **\$196⁰⁵**
DEF Refractometer

- For most Class 7-8 trucks that utilize SCR
- Accurate measurement of UREA concentration in DEF or AdBlue solution



LOCK-OUT TOOLS & ACCESSORIES

AccessTools
"The undisputed leader in specialty tools"

AET-AMSC **\$500³⁵**

Super Combo Complete Set

- Best selling complete set
- Best selling accessories included
- 1979-present vehicles
- Instructional DVD & manual
- Tool ID system
- High quality in-the-door tools



LT
TOOLS

LOC-1000 **\$378⁸⁵**

18-Pc Supreme Master Automotive Lock Out Kit

- This 18 piece set is the ultimate product available to handle emergency lock outs



LT
TOOLS

LOC-145 **\$135⁴⁵**

Super Multi-Purpose Easy Access & Inflate-A-Wedge™ Kit

- 4-pc Easy Access Tool for long reach applications
- Includes Plastic Slip Jim (#100), two Plastic Door Wedges (#271), and Inflate-A-Wedge™ (#275)

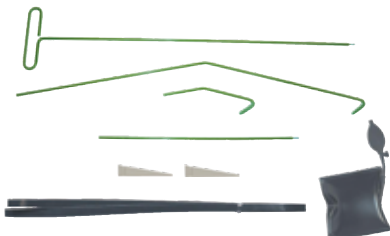

LT
TOOLS

LOC-450 **\$111³⁵**

11-Pc Deluxe Master Automotive Lock Out Kit

- Includes the Lock Tech Tool (#LT108)
- Tool kit unlocks most domestic and foreign cars and trucks



LT
TOOLS

LOC-200 **\$82⁵⁵**

9-Pc Mini Master Automotive Lock Out Kit

- 9 piece low cost tool kit unlocks most domestic and foreign cars and trucks

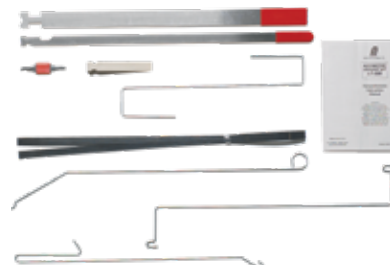

AET-ERK **\$271⁵⁵**

Emergency Response Kit

- Snap-N-Lock Long Reach Tool (SNL)
- Flex Max (FM)
- Button Master (RCBM)
- Super One Hand Jack Tool (SOHJ)
- One Hand Jack Tool (OHJ)
- Super Air Wedge (SAW)
- Glassman Wedge (GM2)
- Wonder Shield (WS)
- Instructional DVD with Follow-the-Pro videos
- Quick One-Hand Jack manual

AccessTools
"The undisputed leader in specialty tools"



AccessTools
"The undisputed leader in specialty tools"



AET-OHJS4 **\$142⁸⁵**

One Hand Jack Set

- Quick Max Long Reach (QM)
- Button Strip Tool (BS)
- Air Jack® Air Wedge (AW)
- One Hand Jack (OHJ)
- Heavy duty carrying pouch (SCS)
- Instructional DVD



LT
TOOLS



LOC-140 **\$105⁸⁵**

Easy Access & Inflate-A-Wedge™ Kit

- 2 piece Easy Access Tool is 53" long and collapses for easy storage
- Kit includes Plastic Slip Jim (#100), two Plastic Door Wedges (#271), and Inflate-A-Wedge™ (#275)

AccessTools
"The undisputed leader in specialty tools"



AET-FACOS **\$114³⁵**

Fast Access Car Opening Set

- Kit contains the basic tools and accessories needed to open any vehicle quickly, easily, and without damage
- Flex Max Long Reach (FM)
- Air Jack® Air Wedge (AW)
- One Hand Jack (OHJ)
- Button Strip Tool (BS)
- 3 extra tips





AET-RCMM **\$81²⁵**

Mega Master

- 68" long flexible coated long reach tool
- Extra large retractable loop
- Grabs door handles, keys, knobs, etc.



STK-32950 **\$75⁷⁵**

The BigEasy™ GLO Car Unlocking Kit

- 55" long access tool (glow-in-the-dark yellow)
- Kit includes: non-marring wedge, lock knob lifter, paint protector

AET-QM **\$51⁶⁵**

Quick Max 51" Long Reach Tool

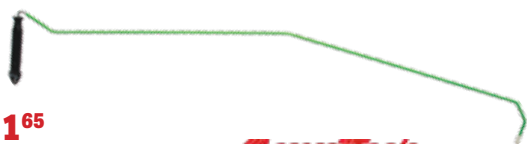

AET-RCBM **\$66⁴⁵**

38" Long Button Master

- Grab vertical door buttons with ease



STK-32903 **\$14⁰⁵**

BigEasy™ Loop Accessory

- Glows in the dark for night time use
- A snap-on tool that fits all BigEasys
- Allows for grabbing of door handles and window handles



One Hand Jack

- Use the One Hand Jack to create working room to insert your Air Jack®

Item #	Description	
AET-OHJ	Standard One Hand Jack Tool	\$36.85
AET-SOHJ	Super One Hand Jack Tool Large size for big sedans and SUVs	\$44.25



Air Jack® Air Wedges

- Won't damage the vehicle
- Inflates easily and quickly

Item #	Description	
AET-AW	Air Jack® Air Wedge	\$66.45
AET-SAW	Air Jack® Super Air Wedge	\$73.85
AET-TAW	Air Jack® Twin Air Wedge	\$88.65

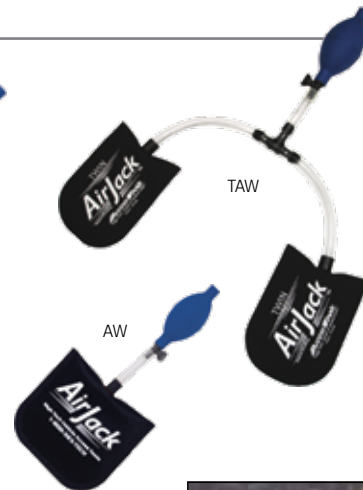

STK-32922 **\$53²⁵**

Easy Wedge

- Inflatable controlled opening of a car door for insertion of the BigEasy



Access Smart Light 2 – 500 Lumens Multi-Purpose Windshield Mounted COB LED Light

- 5 lighting modes: High/Low/Steady Red/Strobing Red/S.O.S. Red
- Adjustable hanger arm/stand
- Impact resistant
- Runs on 3AA batteries (not included)



AIR CONDITIONING SYSTEM SERVICE

A/C Refrigerant Recovery, Recycling & Recharging Machines



A/C Recover, Recycle, Recharge Machines



ARCTIC COMMANDER	MTC-COMMANDER4000	MTC-COMMANDER2000	MTC-COMMANDER3000
FEATURES	Automatic R1234YF & HYBRID	Automatic R134A	Automatic R134A & HYBRID
8" Colour Command Center with Touch Screen	■	■	■
Automatic and Manual Procedures	■	■	■
Refrigerant Database	■	■	■
Automatic Vacuum Leak Test: Programmable	■	■	■
Auto Oil Discharge	■	■	■
Auto and Manual Air Purge	■	■	■
Auto Filter and Full Tank Alarm	■	■	■
Low Refrigerant Alarm	■	■	■
Auto Oil Injection	■	■	■
Thermal Printer	■	Optional	■
Hose Flushing	■	■	■
Vehicle A/C System Flushing	■	■	■
Tank Heater	■	■	■
6 CFM Vacuum Pump	■	■	■
Refrigerant Identifier	■	■	■
On-Board Unit Conversion Calculator	■	■	■
Self-Diagnostic Check	■	■	■
Wi-Fi Capable	■	■	■



A/C Recover, Recycle, Recharge Machines



	ROB-AC1234-9	ROB-AC1234-4	ROB-34788NI	ROB-34788NI-H
FEATURES	R1234YF & Hybrid & Non-Hybrid	R1234YF & Hybrid	R134A	R-134A Hybrid & Non-Hybrid
Connection	Incorporated Wi-Fi & Bluetooth® Technology	Wi-Fi & Bluetooth® Capable (optional kit)	Wi-Fi Capable (optional kit)	Wi-Fi Capable (optional kit)
Colour Display	10"	4.3" Diag.	5" x 9"	5" x 9"
Fully Automatic Operation	■	■	■	■
Refrigerant & Oil Database	Optional	Optional	Optional	Optional
Leak Test	■	■	■	■
Automatic Oil Drain	■	■	■	■
Automatic Air Purge	■	■	■	■
Notifications	Visual & Audible	Visual	Visual & Audible	Visual & Audible
Automatic Oil Injection	■	■	■	18480 or 18490 syringe required
Printer	Google Cloud Printing	Optional	Optional	Optional
A/C System Flushing	■	■	■	■
Refrigerant Charging	■	■	■	■
Automatic Refrigerant Refill	■	■	■	■
Refrigerant Identifier	■	■	■	■
1.5 CFM Vacuum Pump	■	■	■	■
Certifications	J2927, J2843, UL1963	J2927, J2843, J2886	J2788	J2788

FREE!
Buy #ROB-AC1234-4 and obtain a free #ROB-30038 Printer. (Value of \$276.00)



ROB-34724 **\$124⁷⁵**
Replacement Filter-Drier for A/C Recover/Recycle/Recharge Machines
 • Spin-on filter for models: 17700A, 17700-2K, 34700, 34700-2K, 34800, 34800-2K, 34900, 34288, 34788, 34788-H, 34888HD, 34988, 34288NI, 34788NI, 34788NI-H, 34988NI, 34998, AC1234-4, AC1234-6, AC1234-9, and similar OEM models



CPS-MX3030
A/C Refrigerant Management Center
 • For use in R134a and R1234yf systems
 • **Compatible with electric and traditional engine-driven compressors**
 • Includes: vehicle database, refrigerant identifier
 • Fully interactive 7" touch-pad screen that is Wi-Fi printer capable and integrates with Bluetooth® wireless adapters for pre and post-service health checks
 • Vacuum pump: 2 CFM, 1/3 HP, 10 micron rated
 • (2) 30 lb recovery tanks & hoses
 • Certified to meet SAE J3030

A/C System Flushers



MTC-69900



“Mastercleanse” A/C Flush Machine

- Flushes all HVAC/R and automotive systems
- Used for removal of all solids and residues caused by breakage of compressor or filters
- Flush container capacity: 2.6 gal (10L)
- Flow rate: 4 gal/min (16L/min)
- Additional external container connection
- External nitrogen bottle connection



MTC-91046-A **\$70⁷⁵**

A/C System Flush Kit

- Designed to work with any light weight flushing agent
- Excellent for quickly and effectively removing refrigerant oil debris during retrofitting or compressor replacement



A/C Recovery Systems



Made in USA

A/C Recovery Systems

- 1/2 HP oil-less compressor
- 115V – 60 Hz

Item #	Description/ Features	Compressor Features	Designed for	Compatible Refrigerants	Compatible with Combustible Gases	Contaminated Refrigerant Removal	DOT Tank	Filter/Dryer	Oil Separator	Manifold Gauge Set	
MTC-69100	• Complete A/C Recovery System	• Spark-free	R134a	All CFCs, HCFCs, HFCs			30 Lbs	✓	✓		
MTC-69110	• Design Certified to Meet SAE J2810	• Spark-free	R134a	All CFCs, HCFCs, HFCs			30 Lbs		✓		
MTC-69360	• Complete A/C Recovery System	• Twin turbo • Spark-free	R134a	All CFCs, HCFCs, HFCs			30 Lbs	✓	✓		
MTC-69360-22	• For all Refrigerated Trucks (“Reefer Units”) • 1/4” Fittings	• Twin turbo • Spark-free		All CFCs, HCFCs, HFCs including R22, R404, R407C & R410a			30 Lbs	✓	✓		
MTC-69360-YF	• Complete A/C Recovery System	• Twin turbo • Spark-free	R1234yf	All CFCs, HCFCs, HFCs	✓ Incl. A2L & A3		30 Lbs	✓	✓		
MTC-69365	• Heavy-Duty A/C Recovery System for Buses & Fleet Applications	• Twin turbo • Spark-free	R134a	All CFCs, HCFCs, HFCs including R410a			50 Lbs	✓	✓		
MTC-69372	• Complete A/C Recovery System	• Twin turbo • Spark-free	R134a & R1234yf	All CFCs, HCFCs, HFCs	✓ Incl. A2L & A3		2 x 30 Lbs	✓	✓	✓	
MTC-69391	• For Contaminated A/C Systems • Meets SAE J2810	• Twin turbo • Spark-free	R1234yf	All CFCs, HCFCs, HFCs including R410a	✓ Incl. A2L & A3	✓	30 Lbs				
MTC-69400-CON	• For Contaminated A/C Systems • Mini, Lighter Weight	• Twin turbo • Spark-free	R134a & R1234yf	All CFCs, HCFCs, HFCs	✓ Incl. A2L & A3	✓	30 Lbs				

AIR CONDITIONING SYSTEM SERVICE

A/C Charging Station



MTC-91585-B **\$1258⁰⁵**

Single Stage Portable Charging Station

- Contains all the necessary tools to quickly and conveniently charge the A/C system
- 240 lb capacity electronic charging scale
- R134a 2-way manifold with 2-1/2" gauges
- 6 CFM single stage vacuum pump
- Manual couplers
- Set of 3 service hoses



MTC-91787



Mobile Monster - 110V Complete Heavy Duty Charging/Recovery Station

- 4-way aluminum manifold (1/4" SAE fittings) with digital gauges for precise calculations of over 90 refrigerants
- 240 lb capacity electronic charging scale
- 6 CFM, 2 stage vacuum pump
- Twin Turbo refrigerant recovery machine with oil separation module, filter dryer and sight glass
- Hoses: 200" blue and red, 72" & 36" yellow, 36" black
- 10" extra large tires
- Dimensions: 36-1/4" x 28-3/4" x 25"



MTC-91585-B-YF **\$1335⁴⁵**

Dual R134a/R1234yf Single Stage Portable Charging Station

- Contains all the necessary tools to quickly and conveniently charge the A/C system
- 240 lb capacity electronic charging scale
- 2-way manifold with 2-1/2" gauges
- 6 CFM single stage vacuum pump
- R134a manual couplers
- R1234yf manual couplers
- R1234yf adapter
- 1/2" acme-M x 1/2" acme-F LH thread fitting
- Set of 3 service hoses



Manifold Gauges

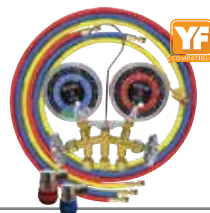

ATD-3661 **\$304⁹⁵**

R1234yf 2-Way Brass Manifold Gauge Set

- (3) 60" hoses
- R1234yf high and low side manual couplers



ATD-3681 **\$282¹⁵**

R1234yf/R134a Brass Manifold Gauge Set

- (3) 60" R134a standard hoses
- 2-1/2" re-calibratable gauges
- Extra access port for vacuum line
- R1234yf high and low side quick couplers
- R134a high and low side economy couplers
- 1/2" (M) x 1/2" (F) LH thread adapter
- (2) 12mm (M) x 14mm (F) R1234yf adapters

A/C Refrigerant Scales



MTC-98210-BL **\$347⁴⁵**

Black Series Electronic Charging Scale with Bluetooth® Wireless Technology

- 243 lbs capacity (110 kg)
- 260 ft. (80m) max. line-of-sight range
- Bluetooth® 4.2 and 5

Functions:

- Charge programming
- Pause/charge
- Tank capacity programming
- Repeat



ATD-3637 **\$363⁵⁵**

Electronic Refrigerant Charging Scale

- 243 lbs capacity (110 kg)
- 9" x 9" platform
- Precise charging capabilities



MTC-98250 **\$230⁸⁵**

Refrigerant Tank Heater Blanket

- Assures total discharge of refrigerant from 30 lb and 50 lb tanks
- Heats tanks to 125°F resulting in a maximum pressure of 185 psi for R134a, and 170 psi for R12
- 300W heater element, 110V



ATD-3694 **\$170⁵⁵**

R12/R134a Deluxe Dual Brass Manifold Gauge Set

- (3) 60" hoses
- Manual couplers
- 1/4" SAE-M x 1/2" ACME-F adapter

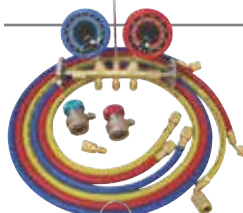

R12/R134a Deluxe Dual Aluminum Manifold Gauge Set

- Manual couplers
- 1/4" SAE-M x 1/2" ACME-F adapter



Item #	Hoses	
ATD-3695	(3) 60"	\$193.55
ATD-3696	(3) 96"	\$239.65

ATD-3693 **\$160⁴⁵**

R134a Economy Manifold Gauge Set

- R134a gauges
- (3) 60" hoses
- Snap couplers
- Gauge guards



Manifold Gauges

CPS-MAID8QYF **\$434⁹⁵**

HFO-R1234yf BlackMax Manifold Gauge Set

- (3) 8 ft. hoses • 1/2" fittings
- Manual couplers



CPS-MAID8QDL **\$497⁸⁵**

R1234yf & R134a BlackMax Manifold Gauge Set

- (3) 8 ft. hoses • 1/2" fittings
- Manual couplers



Mastercool[®]
World Class Quality[™]

MTC-99946-BT-2 **\$884⁰⁵** 4-Way Smart Manifold with Bluetooth[®] for All Gases

- 60" high pressure hoses, black vacuum hose and (2) clamps
- 4.3" colour LCD touchscreen
- Built-in premium vacuum sensor
- Displays: pressure, vacuum, temperature (C°/F°), and will automatically calculate your superheat and subcool
- Data logging, leak test timers and alarms • Free Mastercool Connect app



"Mini-Fold" Digital Compact 2-Way Aluminum Manifold Gauge Sets

- Gauges can perform pressure/temperature calculations for up to 91 different refrigerants including R134a, R1234yf, R410a and R22 refrigerants (appropriate hoses/coupler required)
- Unit conversion between MPa, kPa, bar, psi, kg/cm2, inHg
- Large 4-digit "blue" backlit LCD display



MTC-82172 **\$445⁶⁵** Digital Mini-Fold for R1234yf

- (3) 72" hoses
- R1234yf manual couplers

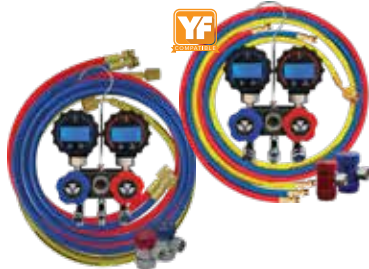

MTC-84472 **\$397³⁵** Digital Mini-Fold for R134a

- (3) 72" hoses
- R134a manual couplers

MTC-89660-PRO5 **\$185²⁵**

R134a 2-Way Manifold Gauge Set

- (3) 60" hoses
- R134a couplers
- 3-in-1 side mount can tap valve



MTC-98661-PRO **\$269⁴⁵**

Dual R134a/R12 2-Way Manifold Gauge Set

- (3) R134a hoses
- (3) R12 hoses
- Manual couplers
- 3-in-1 side mount can tap valve



Mastercool[®]
World Class Quality[™]

MTC-89661-AYF **\$371⁵⁵**

R1234yf/R134a Aluminum Manifold Gauge Set

- 2-1/2" re-calibratable gauges
- Extra access port for vacuum line
- R1234yf high and low side couplers
- R134a high and low side manual couplers
- 1/2" acme-M x 1/2" acme-F left hand thread adapter
- (2) 12mm-M x 14mm-F R1234yf adapters
- (3) R134a standard hoses



MTC-81661 **\$247⁷⁵**

R1234yf 2-Way Brass Manifold

- (3) 60" hoses
- R1234yf high and low side couplers
- 3-1/8" gauges
- Bar/PSI units of measure

MTC-83272 **\$322²⁵**

R1234yf 2-Way Piston Valve Manifold

- (3) 72" hoses
- R1234yf high and low side couplers
- 3-1/2" gauges
- Bar/PSI units of measure

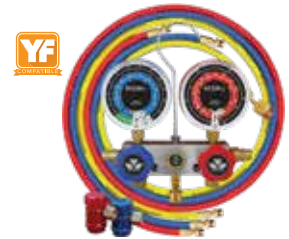

53376



Visual Inspection Sight Glass Kits

- Save time by easily determining if the A/C system needs to be flushed
- Unit can be used with a standard vacuum pump or with the vacuum function of your R/R/R machine
- Allows user to visually inspect the refrigerant in any R134a or R1234yf system and identify excess dye, oil or debris
- Allows the user to extract a small portion of the refrigerant for actual visual inspection
- Leak free, ball valve controlled and will allow the refrigerant extracted for the visual inspection to be deposited back into the system
- Kits include: 60" blue and red charging hoses, high and low side quick couplers

Item #	Refrigerant	
MTC-53376	R134a	\$240.55
MTC-53376-YF	R1234yf	\$263.65

AIR CONDITIONING SYSTEM SERVICE

Manifold Gauges

ROBINAIR

ROB-48134B **\$254⁷⁵**

R12 & R134a Brass Manifold Set and Service Couplers

- 60" R134a & R12 hose set
- 90° manual service couplers



ROB-49134B **\$290²⁵**

R12 & R134A Aluminum Manifold Set and Service Couplers

- 60" R134a & R12 hose set
- 90° manual service couplers



ROB-49134A **\$222¹⁵**

R134a Aluminum Manifold Set

- 60" R134a hoses
- 90° manual service couplers



ROB-48510 **\$419³⁵**

R134a Aluminum Manifold Gauge Set

- 3-1/8" gauges
- 72" R134a hoses (1/2" ACME x 14mm)
- 90° manual couplers



ROB-41234 **\$602⁹⁵**

R1234yf Aluminum Manifold Gauge Set

- Oversize 3-1/8" adjustable gauges
- 72" hoses
- R-1234yf vehicle couplers



ROB-45111 **\$346⁰⁵**

R134a 2-Way Brass Manifold Gauge Set

- R12/R134a gauges, PSI, and °F temp
- 90° manual couplers
- 72" R134a hoses (1/2" ACME x 14mm)



Service Couplers

ROBINAIR

R-134a Manual Couplers

Item #	Description	
ROB-18190A	Low Side	\$80.25
ROB-18191A	High Side	\$80.25

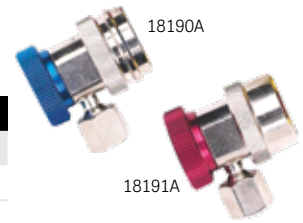

R-134a Manual Couplers, 14mm

Item #	Description	
CPS-QCL134	Low Side	\$40.05
CPS-QCH134	High Side	\$33.95
CPS-QC134SET	2-Pc Set	\$65.95



R-134a to HF01234yf Conversion Manual Couplers, 14mm

Item #	Description	
CPS-QCL1214MM	Low Side	\$53.15
CPS-QCH1214MM	High Side	\$45.25
CPS-QC1214SET	2-Pc Set	\$112.15



Mastercool
"World Class Quality"



MTC-82834-SL **\$55⁰⁵**

High Side Manual R134a Safety Lock Coupler

- 14mm-F x 16mm

MTC-82934-SL **\$55⁰⁵**

Low Side Manual R134a Safety Lock Coupler

- 14mm-F x 13mm



MTC-83834 **\$74⁰⁵**

High Side R1234yf Coupler

- 12mm-F x 17mm

MTC-83934 **\$74⁰⁵**

Low Side R1234yf Coupler

- 12mm-F x 14mm



MTC-83736-K **\$142⁸⁵**

R134a to R1234yf Conversion Kit

- Converts any R134a manifold gauge set to a R1234yf manifold gauge set

ATD-3525 **\$40⁵⁵**

R12 to R134a Conversion Kit

- Converts R12 gauges to R134a
- Contains R134a 90° quick couplers and 1/2" ACME F x 1/4" M adapter for R134a refrigerant tank



A/C Vacuum Pumps



MLW-2941-21 **\$1198⁹⁵**

M18 FUEL™ 5 CFM Vacuum Pump Kit

- 1/2", 3/8" & 1/4" ports
- As fast as corded
- Up to 20% higher air flow versus corded
- Up to 90 min runtime with Manifold Mode
- Up to 60 min runtime in Default Mode



90062-BL

90066-BL

Single Stage Vacuum Pumps

- Ultimate vacuum: 80 microns

Item #	CFM	Motor	
MTC-90062-BL	3	1/4 HP	\$252.35
MTC-90066-BL	6	1/3 HP	\$315.55



High Efficiency Single Stage Vacuum Pumps

- Ultimate vacuum: 80 microns

Item #	CFM	Motor	
ATD-3451	1.8	1/4 HP	\$276.95
ATD-3453	3	1/4 HP	\$322.35
ATD-3456	5	1/3 HP	\$429.75



ATD-3410 \$64⁸⁵ 4.2 CFM Air-Operated Vacuum Pump for R134a & R12

- Operates on shop air: 75 PSI min. / 180 PSI max.
- Includes 1/4" flare (R12) connection and 1/2" ACME (R134a) connection



CPS-VP6D **\$658⁴⁵**

Pro-Set® 6 CFM 2-Stage Vacuum Pump

- 1/2 HP motor
- Dual voltage operation: 110-120V/220V; 50/60Hz
- Vacuum rating as low as 10 microns
- Intake fittings: 1/4" SAE, 3/8" SAE and 1/2" ACME



CPS-VG200 **\$295³⁵**

Vacrometer™ Electronic Vacuum Gauge

- 5 digit LCD display reads Microns, Torr, In/Hg or mBar
- Connect directly to vacuum pump to ensure performance
- Includes: hanging hook, carrying case and AVT45 brass adapter



A/C Service Tools



MTC-71550 **\$396²⁵**

Manual Style A/C Hose Crimper

- Can be mounted to a bench or held securely in a vice
- Complete set of dies covering standard hose sizes #6, #8, #10, #12



MTC-71500-A **\$1248⁷⁵**

Hydra-Krimp Deluxe Hand-Held Hydraulic Press

- Crimps barbed and beaded fittings
- Complete set of dies covering hose sizes #6, #8, #10, #12 and reduced barrier #6, #8, #10, #12



MTC-91000-A **\$152⁵⁵**

Universal A/C Compressor Clutch Hub Puller/Installer Kit

- Works on GM, Ford, Chrysler and Imports



ROB-EVDC100 **\$773⁰⁵**

A/C Electronic Variable Displacement Compressor Tester

- Quickly tests electronic control valves in variable displacement compressors to determine if functioning correctly and eliminating compressor misdiagnosis
- Adjustable tester dial mimics variable voltage signal to compressor for wide-range testing
- Includes connect adapters for both old and newer style compressors



AIR CONDITIONING SYSTEM SERVICE

A/C Service Tools

CPS-TAC100 **\$466⁶⁵**

CarSmart – A/C Inspection Tool

- Accurately measures and records temperature and relative humidity
- Measures air entering the A/C system and compares it to the air supplied through the vents in the vehicle cabin
- Works with the CarSmart App to send detailed reports to a smartphone or tablet
- Provides professional on-screen or printed reports



ATD-3638 **\$10⁴⁵**

Universal Large Bore A/C Valve Core Remover/Installer

- Used on R12/R134a standard and JRA/EATON large bore R134a valve cores



MTC-81290 **\$10⁸⁵**

R12/R134a Universal Valve Core Remover

- For R12/R134a Standard and JRA/EATON large bore R134a valve cores



IMP-126C **\$30⁶⁵**

Reversible Ratcheting Wrench for Refrigeration and A/C Service

- 1/4", 3/8", 3/16" and 5/16" square drives



LIS-64180 **\$88⁸⁵**

Actuator Motor Wrench Set

- Toothless, infinite ratchet and hinged handle design make it easier to remove and replace fasteners on small, electric HVAC motors
- The ratchet can be flipped to switch from clockwise to counterclockwise drive
- Includes 5.5mm, 7mm, 8mm sockets and 1/4" square drive adapter



ATD-3880 **\$75⁷⁵**

R12/R134a Valve Core Repair Kit

- Includes valves cores for:
- (20 ea.) Standard R12/R134a
 - (3 ea.) GM R12/R134a
 - (5 ea.) JRA (M6) R134a
 - (3 ea.) Eaton SSV (M8) R134a
 - (3 ea.) Eaton SSV (M10) R134a



MTC-91337 **\$115⁷⁵**

R12/R134a Valve Core Repair Kit



A/C Refrigerant Identifiers



NEU-7081000620

Mini ID R134a Refrigerant Identifier

- Verifies the presence and quality of R134a refrigerant
- Accuracy: PASS/FAIL 95% pure R134a



NEU-7081000640

Mini ID R1234yf Refrigerant Identifier

- Verifies the presence and quality of R1234yf refrigerant
- Accuracy: PASS/FAIL 95% pure R1234yf



7081234330

7081234300



Legend Series™ Refrigerant Analyzers for R12, R134a, and R-1234yf

- Connects directly to SAE J2843 and J3030 A/C service machines that have an external analyzer USB port
- Refrigerants measured: R1234yf, R134a, R12
- Contaminants measured: R-22, Hydrocarbons, Unknown
- Refrigerant % displayed: R1234yf, R134a, R22, R12, HC, Unknown, Air
- Power: 12VDC @ 1.5 amps
- Communication protocols: USB 2.0, Bluetooth 2.0
- Multilingual

Item #	Model	
NEU-7081234330	Base Model	
NEU-7081234300	With Printer	

Electronic Leak Detectors

MTC-55600 **\$681⁸⁵**

Black Series Infrared Refrigerant Leak Detector

- Advanced TFT screen provides clear and easy readings using color graphics that show leakage, sensitivity, battery level and sensor fault indicators
- Visual and audible alarm
- Target scan mode
- Responds to all halogenated refrigerants including but not limited to: HFC's, HCFC's, CFC's, PFC's, HFO's
- High, Medium and Low sensitivity



MTC-55800 **\$531²⁵**

Intelliasense Refrigerant Leak Detector

- Detects Combustible Gases, Hydrogen, and all Refrigerants (CFC's, HCFC's & HFC's)
- New metal oxide gas sensor for the detection of chlorofluorocarbon gases and blends
- High sensitivity and a fast response
- Unit works with R1234yf, R32 and R410a
- High, Medium and Low sensitivity



MTC-55900 **\$364⁰⁵**

Intelliasense II Refrigerant Leak Detector

- Detects all refrigerants (HFC, CFC, HCFC, and blends)
- Intelligent tip eliminates potential of false alarms
- High, Medium and Low sensitivity



MTC-56200 **\$362⁰⁵**

"Raptor" Refrigerant Leak Detector with UV Blue Light

- Detects all refrigerants (HFC, CFC, HCFC)
- 6 levels of sensitivity (15 levels of detection)
- Variable frequency audible alarm
- Visual leak level indicator



CPS-LDA1000UV **\$567³⁵**

Pro-Set® Refrigerant Leak Detector with Mini UV Light

- R134a & 1234yf
- Visual and audible leak indicators



CPS-LS790B **\$512⁷⁵**

Leak-Seeker® Refrigerant Leak Detector

- 10 sensitivity ranges to detect all non-combustible CFC, HCFC, HFC gases and blends
- Visual and audible alarms

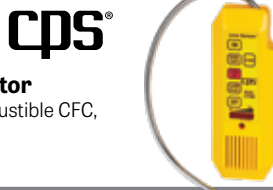

ROB-LD3 **\$538⁶⁵**

Economy Refrigerant Leak Detector

- Compatible with most used refrigerants including R-1234yf and R-134a
- Automatic calibration
- 3 adjustable sensitivity levels



ROB-LD7 **\$825³⁵**

Premium Refrigerant Leak Detector

- Compatible with most used refrigerants including R-1234yf and R-134a
- Colour display with graphics and visual alerts
- UV and Clear LED inspection lights
- Automatic and manual calibration
- 3 adjustable sensitivity levels



Nitrogen Leak Detectors

CPS-NITROKITG **\$523¹⁵**

A/C Nitrogen Pressure Leak Test Kit

- Quickly and accurately locate large leaks in R1234yf and R134a A/C systems
- The sound of escaping gas at the point of the leak will assist the Technician in locating the leak

Kit includes:

- 1-valve manifold with a 0-200 PSIG 3-1/8" gauge
- Nitrogen regulator
- 6 ft. red 1/4" service hose
- 15 ft. yellow hose assembly with 1/4" MPT x 1/4" coupler
- High side R-134a coupler
- High side R-1234YF coupler



Spray-On Leak Detectors

Big Blu® Spray-On Micro Leak Detector

- The Original Big Blu® bubble leak detector is used by OEM's and industry professionals worldwide
- Temp range: +35°F to 177°F
- Detects micro leaks down to 0.65 oz/year
- Non-toxic
- Non-corrosive
- Biodegradable
- Safe on any type of gas including Oxygen



Item #	Size	
BLU-RT100S	946ml	\$22.15
BLU-RT100G	1 Gallon	\$62.85

A/C Sealant Detectors



NEU-7081000510 **\$720¹⁵**

Model ACSD QuickDetect™ A/C Sealant Detection Kit

- Quickly verifies if there is harmful sealant in the vehicle's A/C system
- Prevents possible damage to valuable refrigerant recovery equipment
- Works with R134a and R12 systems



NEU-7081000520 **\$435⁶⁵**

Refill Cartridges for Model ACSD Sealant Detector, Pack of 25



AIR CONDITIONING SYSTEM SERVICE

Ultraviolet Flashlights



\$99³⁵

UVW-413075

UV Phazer™

- UV Power rating: 810
- Adjustable lens focus
- Includes 3 AAA batteries



\$167⁹⁵

UVW-413065

Rechargeable UV Phazer™

- UV Power rating: 810
- Adjustable lens focus
- Compact design



\$175⁶⁵

UVW-413025

Rechargeable UV Phazer NEO™

- UV Power rating: 1,135
- Adjustable lens focus
- Compact design

MTC-53515 **\$74³⁵**

Mach IV Flexible UV Light

- Has 4 TRUE UV LEDS delivering a brilliant fluorescent glow



MTC-53518-UV **\$134⁹⁵**

Rechargeable UV Flashlight

- Zoom the UV light in or out
- 3 to 5 hours continuous use
- 50 Watt UV LED
- 2 illumination modes



HBF-TPOPUVM **\$191⁰⁵**

OPTI-PRO™ UV MAX Leak Detection Flashlight

- Adjustable focus
- 30 ft. inspection range
- High/Low/Strobe light
- Includes: (3) AA batteries, glasses



LKF-LF500CS **\$51⁰⁵**

UV Light LED Leak Detection Compact Flashlight

- 5 ft. inspection range
- Includes: (3) AAA batteries, glasses



Ultraviolet Leak Detection



A/C ExtenDye™

- For use in R-134a and R-1234yf systems

Item #	Description	Unit Size	Max. Applic.	Qty	
UVW-499008A	Bottle design with dosing chamber	8 oz/ 240 ml	64 vehicles	1	\$63.85
UVW-499108A	Works exclusively with the Spotgun™ Injection System	8 oz/ 240 ml	64 vehicles	1	\$77.35
UVW-399020A	Works exclusively with the Spotgun Jr.™ Injection System	1 oz/ 30 ml	40 vehicles	4	\$57.05
UVW-399006A	Works exclusively with the Spotgun Jr.™ Injection System	0.25 oz/ 7.5 ml	1 vehicle	6	\$56.65
UVW-B499024A	Bottle	1 oz/ 30 ml	10 vehicles	6	\$80.55
UVW-B499012A	Bottle	0.25 oz/ 7.5 ml	12 vehicles	12	\$99.75



UVW-499005

\$61⁸⁵

Universal A/C Dye

- For use in R-134a PAG systems, R-1234yf systems with PAG oil
- Hybrid safe
- 4 oz/120 ml
- Max. applications: 32



Universal/Ester A/C Dyes

- For use in R-134a and R-1234yf systems



Item #	Description	Unit Size	Max. Applic.	Qty	
HBF-TP9770-8	Works with BigEZ™ dye injector	8 oz/ 237 ml	64 vehicles	1	\$83.85
HBF-TP3840-1P6	Works with refillable in-line injector and syringe injector	1 oz/ 30 ml	24 vehicles	6	\$81.45
HBF-TP9870-P6	Works with EZ-Ject™ dye injector	0.5 oz 15 ml	Each up to 14 vehic.	6	\$113.85



Universal A/C Leak Detection Dye

- Compatible with R-134a, R-1234yf, R-12

Item #	Qty of Bottles	Services (Up To)	
LKF-LF1001CS	1 x 1 oz/30ml	4 Vehicles	\$11.55
LKF-LF1001	6 x 1 oz/30ml	24 Vehicles	\$49.45



LKF-LF1800 **\$64²⁵**



BigEZ™ Universal A/C Dye Cartridge

- Compatible with R-134a, R-1234yf, R-12
- Fits most caulking gun-style injectors
- (1) 8 oz (237 ml) bottle, services up to 64 vehicles



Ultraviolet Leak Detection

UVW-471500A **\$146¹⁵**

Spotgun™ System Kit

- Services up to 64 vehicles
- Includes:
 - Spotgun™ injector with R-12 and R-134a adapters
 - A/C ExtenDye cartridge (8 oz/240 ml)
 - Service stickers



UVW-414500A **\$387⁸⁵**

Spotgun™/Micro-Lite™ Kit

- Services up to 64 vehicles
- Includes:
 - 50W Micro-Lite™
 - Spotgun™ injector with R-12 and R-134a adapters
 - A/C ExtenDye cartridge (8 oz/240 ml)



UVW-332005A **\$195⁴⁵**

Spotgun™ Jr./UV Phazer™ Black (AAA) Kit

- Services up to 40 vehicles
- Includes:
 - UV-Phazer Black
 - Spotgun Jr. injection system with R-12 and R-134a adapters
 - A/C ExtenDye cartridges (4 x 1 oz/30ml)



UVW-471540 **\$98³⁵**

Spotgun™ R-1234yf Hose Assembly with Coupler



HBF-TPOPUV16 **\$416⁸⁵**

Complete A/C & Fluid UV Leak Detection Kit

- Compatible with R-1234yf, R-134a and more, oil-based fluids, coolant
- TP9770-8: 8 oz (237 ml) BigEZ™ Universal/Ester cartridge
- TP3400: 1 oz (30 ml) dye for all circulating oil-based fluids
- TP-3900: 1 oz (30 ml) coolant dye
- TP9749: EZ-Shot™ dye injector
- TP11: R-134a hose/coupler with BigEZ™ adapter & purge fitting
- TP19: fluorescent dye cleaner
- TP9831: R-1234yf adapter



HBF-TPOPUV19 **\$309⁶⁵**

R-1234yf/PAG A/C Dye UV Leak Detection Kit

- TP9835-P3: (3) 0.25 oz (7 ml) cartridges of Mini-EZ™ R-1234yf/PAG single-dose A/C dye
- TP9845: EZ-Ject™ dye injector
- TP10: R-1234yf hose/coupler & purge fitting
- TP19: fluorescent dye cleaner



HBF-TPOPUV20EV **\$407⁴⁵**

POE-Based EV A/C Dye UV Leak Detection Kit

- Compatible with R-1234yf & R-134a
- TP9815EV-P3: (3) 0.25 oz (7 ml) cartridges of Electric Vehicle POE-based A/C Dye Mini-EZ™ cartridges
- TP9845: EZ-Ject™ dye injector
- TP-9813: R-134a coupler and purge fitting
- TP19: fluorescent dye cleaner
- TP9831: R-1234yf adapter



HBF-TP9790-BX **\$243⁰⁵**

EZ-Shot™ Dye Injection Kit for Universal/Ester

- Compatible with R-1234yf & R-134a
- TP9770-8: 8 oz (237 ml) BigEZ™ Universal/Ester cartridge
- TP9749: EZ-Shot™ dye injector
- TP11: R-134a hose/coupler with BigEZ™ adapter & purge fitting
- TP9831: R-1234yf adapter



LKF-LF810 **\$166⁷⁵**

BigEZ™ Universal A/C Dye Injection Kit

- Compatible with R-134a, R-1234yf, R-12
- R-134a hose/coupler and purge fitting*
- LF1800: 8 oz (237 ml) BigEZ™ universal A/C dye cartridge
- *R-1234yf systems require LeakFinder® LF60CS adapter (sold separately)



LKF-LF016 **\$273³⁵**

BigEZ™ Universal A/C Leak Detection Kit

- Compatible with R-1234yf/R-134a/PAG
- LF50: dye injector
- BigEZ™ R-134a hose/coupler and purge fitting*
- LF1800: 8 oz (237 ml) BigEZ™ universal multi-dose A/C dye cartridge
- *R-1234yf systems require LeakFinder® LF60CS adapter (sold separately)



LKF-LF021 **\$163⁹⁵**

Complete A/C & Fluid UV Leak Detection Kit

- LF200C: A/C dye reusable syringe injector
- LF1001: 1 oz (30 ml) of universal A/C dye
- LF2001: 1 oz (30 ml) of oil-based dye
- LF3001: 1 oz (30 ml) of coolant dye
- LF300C: R-134a hose/coupler with purge fitting*
- *R-1234yf systems require LeakFinder® LF60CS adapter (sold separately)



LKF-LF020CS **\$81⁰⁵**

SOLO-SHOT™ Single-Use Syringe Universal A/C Leak Detection Kit

- Compatible with R-1234yf & R-134a
- (2) single-use, disposable syringes, prefilled with LeakFinder® universal A/C dye
- LF80CS: SOLO-SHOT™ R-134a hose/coupler and purge fitting*
- *R-1234yf systems require LeakFinder® LF60CS adapter (sold separately)



AIR CONDITIONING SYSTEM SERVICE

A/C Sealants & Injectors

UVW-480300 **\$124⁷⁵**
LeakGuard™ Spotgun™ Jr.
A/C Sealer Injection Kit

- 2 x (1 oz/30mL) LeakGuard cartridges, and a primer cartridge
- Services 8 vehicles



UVW-480301 **\$25⁴⁵**
LeakGuard™ Professional A/C Sealer

- Works exclusively with the Spotgun Jr.™ Injection System
- 1 oz/30 ml cartridge, services 1 vehicle
- Contains concentrated A/C dye



LEAKFINDER™
 LKF-LF200CS **\$26³⁵**
A/C Leak Sealant
Single-Use Syringe Injector

- Dual adapter for both R-1234yf and R-134a systems
- **A/C machine & equipment safe:** Does not affect refrigerant RRR equipment. Non-hardening sealant formula.
- **Compatible with Hybrid/EV systems**
- Compatible with all popular refrigerants



A/C Oils & Injectors



Oil Injectors for YF, EV & Hybrid Vehicles

- Syringe-type injectors add oil to a fully pressurized A/C system
- Lets you fill the barrel with the amount of oil needed
- Not recommended for UV dye injection

Item #	Refrigerant	Label	
ROB-18480	R-134a	PAG-labeled for gasoline and diesel vehicles	\$217.95
ROB-18490	R-134a	POE-labeled for hybrid and electric vehicles	\$217.95
ROB-18460	R-1234yf	Unlabeled 1234yf oil injector	\$290.55
ROB-18465	R-1234yf	PAG-labeled for gas and diesel vehicles	\$290.55
ROB-18470	R-1234yf	POE-labeled for hybrid and electric vehicles	\$290.55

VIEW
 UVW-481500 **\$106³⁵**
Spotgun™
Oil Injection Kit

- Includes:
- Spotgun™ injector with R-12 and R-134a adapters
 - PAG 46 oil cartridge (8 oz/240 ml)



UVW-481500YF **\$122⁶⁵**
Spotgun™
HFO Oil Injection Kit

- Includes:
- Spotgun™ injector with R1234yf adapter
 - PAG 46 HFO oil cartridge (8 oz/240 ml)



A/C PAG Oils

- Spotgun **cartridge-type** PAG oils utilize the Spotgun injection system to inject a precise measured amount of A/C Oil

Item #	Description	Viscosity	Unit Size	Qty	
UVW-488046P	Spotgun Cartridge	46	8 oz/240 ml	1	\$22.75
UVW-488046YF	Spotgun Cartridge compatible with R1234yf	46	8 oz/240 ml	1	\$32.05
UVW-488100P	Spotgun Cartridge	100	8 oz/240 ml	1	\$22.75
UVW-488125P	Spotgun Cartridge	125	8 oz/240 ml	1	\$22.75
UVW-488150P	Spotgun Cartridge	150	8 oz/240 ml	1	\$22.75
UVW-488046PBD	Bottle with A/C Extendye™	46	8 oz/240 ml	1	\$12.75
UVW-488100PBD	Bottle with A/C Extendye™	100	8 oz/240 ml	1	\$17.25

A/C ESTER Oils

- eBOOST™ increases the lubricity and anti-wear properties of A/C oil and rejuvenates rubber seals and O-rings
- Spotgun **cartridge-type** ESTER oils utilize the Spotgun injection system to inject a precise measured amount of A/C Oil



Item #	Description	Viscosity	Unit Size	Qty	
UVW-488016E	Universal ESTER Oil with Dye and eBOOST	150	16 oz/480 ml	1	\$36.65
UVW-488104H	Spotgun Cartridge Hybrid ESTER Oil	100	4 oz/120 ml	1	\$44.35
UVW-488108E	Spotgun Ester Oil Cartridge	100	8 oz/240 ml	1	\$30.25

Infrared Thermometers

Milwaukee

2268-20



2278-20

12:1 Infrared Thermometers

- Temperature range: -22°F to 1,022°F
- Configurable High/Low temperature alert
- Hold, Max, Min, Avg, Diff Modes
- Survives 6 ft. drops

Item #	Required Battery Type	
MLW-2268-20	9V Alkaline Battery (not included)	\$158.45
MLW-2278-20	M12™ 12V Battery (not included)	\$148.65

Raytek

MiniTemp® Infrared Thermometers

- Single laser point
- Temp. selectable: °C or °F
- Storage pouch included with Model #MT6UBV



MT4UVB

MT6UBV

Item #	Ratio	Temperature Range	
RAY-MT4UVB	8:1	-18°C to 400°C (0°F to 750°F)	\$165.45
RAY-MT6UBV	10:1	-30°C to 500°C (-20°F to 932°F)	\$203.25



Infrared Laser Thermometers

Item #	Ratio	Temperature Range	
ATD-70001	12:1	-60°C to 550°C (-76°F to 1,022°F)	\$134.35
TIT-51408	8:1	-50°C to 650°C (-58°F to 1,202°F)	\$65.55
ESI-EST45	12:1	-30°C to 500°C (-22°F to 932°F)	\$56.75
PWP-PPIR500CBINT	10:1	-20°C to 500°C (-4°F to 932°F)	\$66.15

MTC-52224-A-SP **\$101³⁵**

12:1 Infrared Laser Thermometer

- Temperature range: -58°F to 932°F (-50°C to 500°C)



Mastercool®
World Class Quality

MTC-52225-A-SP **\$228²⁵**

30:1 Dual Temp Plus Infrared & Contact Thermometer

- 3 ft. (1m) wire thermocouple included
- Temperature range: -60°C-760°C (-76°F-1,400°F)
- Thermocouple range: -64°C-1,400°C (-83°F-1,999°F)



Wireless Thermometers

PWP-TEMPKIT **\$59⁹⁵**

Wireless Dual Zone Temperature Kit

- Allows for multiple readings simultaneously with a built-in temperature sensor in the base unit, plus a temperature sensor in the remote wireless Probe
- Measuring range: -9°F to 158°F (-22°C to 70°C)
- Wireless reading distance: 16.5 feet

POWER PROBE



Mastercool®
World Class Quality

MTC-52234-BT **\$74¹⁵**

Digital Thermometer/ Hygrometer with Bluetooth® Wireless Technology

- Works with the Mastercool Connect app to remotely provide dry/wet bulb temperature and relative humidity readings
- Relative humidity: 1% to 99%
- Dry/wet bulb temp.: -4°F to 150°F (-20°C to 65°C)
- Bluetooth® range: 260 ft. (80m)



Thermal Imaging Cameras

Mastercool®
World Class Quality

MTC-52325 **\$993²⁵**

Automatic Thermal Imaging Camera

- 2.8" colour LCD screen
- Temperature range: 20°C to 350°C (-4°F to 662°F)
- 32 GB micro SD card
- 3.7V Li-ion rechargeable battery, 3 hrs run time



Pocket Thermometers

ATD

3412

3406

3407



TMDP

cps

Mastercool®
World Class Quality

52223-A

52220



Pocket Thermometers

Item #	Description	Temperature Range	
ATD-3412	Digital	-50°C to 150°C (-58°F to 302°F)	\$30.85
ATD-3406	Analog (1")	0°F to 220°F	\$9.25
ATD-3407	Analog (1-3/4")	0°F to 220°F	\$9.25
CPS-TMDP	Digital	-50°C to 150°C (-58°F to 302°F)	\$25.85
MTC-52223-A	Digital	-50°C to 150°C (-58°F to 302°F)	\$27.85
MTC-52220	Analog	0°F to 220°F	\$12.35

DISCONNECT TOOLS

SLY-14550 **\$44³⁵**

5-Pc Breather Hose Release Tool Set

- Works with Porsche, Audi, BMW, VW, Mini and Mercedes Benz
- 5 sizes for most breather hose fittings



ATD-3399 **\$105³⁵**

15-Pc Deluxe Disconnect Tool Set

- For A/C, fuel, oil cooler, transmission and radiator lines



AST-78930 **\$85⁴⁵**

15-Pc Master Disconnect Kit

- For A/C, fuel, oil cooler, transmission and radiator lines

LIS-39900 **\$97⁷⁵**

Master Disconnect Set

- Contains 8 popular disconnect tools for A/C & fuel lines



LIS-39850 **\$292³⁵**

Master Plus Disconnect Set

- Includes fuel line quick connect and spring lock couplings, A/C line couplings, and transmission oil cooler connectors



LIS-39480 **\$223⁹⁵**

13-Pc Aluminum Spring Loaded Disconnect Set

- For separating oil cooler lines, fuel lines, heater lines and air conditioning line couplings on most vehicles



LIS-37000 **\$14²⁵**

Air Conditioning/Fuel Line Disconnect Tool Set

- 5/16", 3/8", 1/2", 5/8", 3/4", 7/8"



LIS-39960 **\$12⁶⁵**

Ford Transmission Oil Cooler Line Disconnect Set

- 3/8" and 1/2" sizes



LIS-39660 **\$17¹⁵**

Transmission Oil Cooler Line Scissors for Ford & Cadillac

- 3/8" x 1/2"



LIS-39190 **\$21²⁵**

3/4" Heater Hose Disconnect Tool for GM



LIS-39210 **\$29¹⁵**

5/16" Main Fuel Line Disconnect for Toyota & Nissan



LIS-38410 **\$50⁷⁵**

6-Pc DEF & Fuel Line Disconnect Set

- Low profile compact design allows easy access to DEF, breather line, coolant line, and fuel line connectors found on most cars, truck and heavy-duty vehicles
- 1/4" drive allows use with a breaker bar or extension
- 4 sizes to compress and 2 sizes to spread connectors to remove the line: 1-3/8" (34.4mm), 1" (25.4mm), 7/8" (22.6mm), ID .918, ID .623 (OD 1.115), ID .512 (OD .810)



Lisle



ASM-8021 **\$34⁷⁵**

3/8" Transmission Oil Cooler Line Remover



ASM-8023 **\$40⁹⁵**

1/2" Transmission Oil Cooler Line Remover for Ford Models with 6F Transmission



ASM-8026 **\$41³⁵**

5/16" Fuel Line Disconnect Tool

- Comparable to Nissan #J45488 and Toyota #09268-21011



VIM-BCT1 **\$48⁴⁵**

Button Clip Disconnect Tool with 180° Swivel Head

- Quickly disconnect fuel, EVAP, and DEF fittings with button-type connectors. Also works with certain electrical connections.

VIM



Cal-Years

CAL-689 **\$71⁷⁵**

Mercedes Fuel Line Pliers

- These pliers are designed for quick connect, slide and lock couplers found on fuel lines of European and Domestic vehicles
- Applications: Audi, GM, Mercedes including M-class, Toyota and VW models



LIS-37160 **\$35⁵⁵**

Disconnect Pliers for Fuel and EVAP Lines

- Works on fittings with tabs that must be depressed to disengage such as Delphi two tab connectors and some import vehicles

Lisle



LIS-37140 **\$35⁵⁵**

45° Disconnect Pliers for Fuel Line, EVAP Line & DEF Fittings

- Works on fittings with tabs that must be depressed to disengage such as Delphi two tab connectors and some import vehicles
- Can also be used on some electrical connectors



LIS-42400 **\$76¹⁵**

5-Pc Air Line Disconnect Set

- Set comes with five popular sizes: 1/8"-5/32", 1/4", 3/8", 1/2" and 5/8"



Tube Cutters

RGD-32940 **\$170⁰⁵**
**#30 Screw Feed
 Tubing & Conduit Cutter**
 • Cuts 1" - 3-1/8"
 • Cuts copper, aluminum, brass
 and thin-wall steel

RIDGID



375



1125



Ratchet Tube Cutters

• Cuts steel, soft stainless steel, copper, aluminum, brass, plastic and PVC

Item #	Cutting Capacity	
RCU-375	1/8" - 3/8" (3.17mm - 10mm)	\$34.95
RCU-1125	5/16" - 1-1/8" (8mm - 28.5mm)	\$44.25



TITAN



TIT-11490 **\$13⁸⁵**
Mini Tubing Cutter
 • Cuts 1/8" - 7/8" (3-22mm)
 • Cuts copper and brass tube

TIT-11491 **\$53³⁵**
Tubing Cutter
 • Cuts 1/8" - 1-3/8" (3-35mm)
 • Cuts copper and brass tube



Imperial
DEPENDABLE QUALITY PRODUCTS



IMP-TC1050 **\$43⁶⁵**
IMP® Mini Metal Tube Cutter
 • For 1/8" to 5/8"
 (4mm to 15mm) O.D. tubing
 • Includes (1) general purpose
 cutter wheel

IMP-TC1000 **\$84⁵⁵**
Hi-Duty® Tube Cutter
 • For 1/8" to 1-1/8"
 (4mm to 28mm) O.D. tubing
 • Includes (2) general purpose
 cutter wheels

\$133³⁵

DEW-DWACPRIR

IMPACT CONNECT™ Copper Pipe Cutter Attachment

• Works with select Dewalt® 20V MAX*
 and other pro-grade 18V impact drivers
 • **Cut capacity: up to 1"** (1" cutting wheel sold separately)
 • Includes 1/2" & 3/4" cutting wheels



DeWALT

\$133³⁵

DEW-DWAPVCIR

IMPACT CONNECT™ PVC/PEX Pipe Cutter Attachment

• Works with select Dewalt® 20V MAX*
 and other pro-grade 18V impact drivers
 • Make clean, efficient cuts in PEX, PVC, ABS,
 plastic conduit, and other plastic pipe
 • **Cut capacity: up to 2"** schedule 40 and 80 PVC



Tube Benders

Handheld Tubing Straightener

• Straightens bent or coiled tubing
 • Works on aluminum and copper tubing
 • 4 sets of precision-aligned steel roller dies
 • Compact for use in tight spaces

TITAN



Item #	Tube Cap.	
TIT-85566	1/8"	\$145.85
TIT-85564	5/16"	\$145.85
TIT-85563	3/8"	\$145.85
TIT-85565	1/2"	\$145.85

ATD-5472 **\$55⁴⁵**

Triple Head 180° Tube Bender

• Makes 180° bends in 1/4", 5/16" and 3/8"
 copper, brass, aluminum and steel tubing

ATD



ATD-5479 **\$50¹⁵**

4-in-1 Tubing Bender

• Bends 3/16", 1/4", 5/16" and 3/8"
 outside diameter brass, copper,
 steel or aluminum tubing

ATD



TIT-51527 **\$35⁷⁵**

9" Tube Bending Pliers

• For use in bending, aligning or
 adjusting brake, fuel and other small
 tubing in confined areas without
 kinking lines
 • Fits 3/16" and 1/4" diameter tubing

TITAN



IMP™ Triple Head Tube Benders

• For soft copper, aluminum,
 and thin wall steel tubing
 • Makes up to 90° bends
 • Left-hand, right-hand and offset bends

Imperial
DEPENDABLE QUALITY PRODUCTS

367-F



368-F



Item #	Tubing O.D.	
IMP-367FH	1/8", 3/16", 1/4"	\$72.15
IMP-368FH	3/16", 1/4", 5/16", 3/8"	\$84.25

IMP-370FH **\$136⁵⁵**

Triple Head 180° Tube Bender

• Tubing O.D.:
 3/16", 1/4", 3/8", 1/2"



IMP-470FH **\$119³⁵**

Triple Head 180° Tube Bender with Roto-Lok™ Indexing Handle

• Tubing O.D.: 3/16", 1/4", 5/16", 3/8"
 • Compact design for working
 in tight spaces



Flaring Tools

CPS-BFT850DR **\$476⁵⁵** cps®

Blackmax® Ratchet/Drill Powered Flaring Tool

- Makes 45° flares in soft copper tube from 3/16" to 3/4" O.D.
- Forward or reverse ratchet handle
- Replace ratchet handle with a cordless drill for even faster flaring! (Drill not included)



Universal Hydraulic Flaring Tool Sets with GM Dies and Adapters

- Includes #70027 mini tube cutter for 1/8" to 5/8" (3mm - 16mm) O.D.

Both kits fabricate:

- Push connect: 1/4", 5/16" and 3/8"
- Flare/double flare: 3/16", 1/4", 5/16", 3/8" and 1/2"
- Metric bubble flare: 4.75mm, 6mm, 8mm, and 10mm
- GM fuel line flare, brake lines and transmission: 5/16" and 3/8"

#MTC-72485PRC also fabricates:

- GM transmission cooling line 3/8" and 1/2"



72485PRC



Item #	Price
MTC-72475PRC	\$560.55
MTC-72485PRC	\$603.65



OTC-6502 **\$204⁶⁵** OTC

Master Brake Flaring Tool Kit

- Single: 3/16"-1/2", 4-14mm
- Double: 3/16"-1/2", 4-10mm
- Bubble: 3/16"-1/2", 4.75-10mm



CAL-165 **\$147⁹⁵** Carter

Master In-Line Flaring Tool Kit

- Double and single flares: 3/16", 1/4", 5/16", 3/8"
- Double and bubble flares: 4.75mm, 6mm, 8mm



ATD-5478 **\$189⁰⁵** ATD

Master Flaring and Tubing Tool Set

- For use on steel brake, transmission & fuel lines and copper, aluminum & brass tubing
- Mini tubing cutter for 1/8" to 5/8" diameter tubes



IMP-93FB **\$159⁹⁵**

45° Double Flaring Tool Set

- Makes flares on 3/16", 1/4", 5/16", 3/8" and 1/2" O.D. tubing
- Recommended for Bundy and other annealed soft steel tubing (wall thickness to .035")
- Also makes single or double flares in soft copper or aluminum tubing



OTC-4503 **\$60⁷⁵**

Double Flaring Tool Kit

- Designed for double or single flare in copper, aluminum, soft steel brake line, and brass tubing (to 45 degrees)
- 3/16" to 1/2" (4.8mm to 12.7mm)



ATD-5463 **\$80⁵⁵** ATD

Double Flaring Tool Kit

- Designed for double or single flare in copper, aluminum, soft steel brake line, and brass tubing (to 45°)
- 3/16", 1/4", 5/16", 3/8", and 1/2" adapters



IMP-293F **\$204⁷⁵**

Metric Bubble Flaring Tool

- Makes flares on soft steel or Bundy tubing: 4.75mm (3/16"), 6mm, 8mm and 10mm O.D.
- Will flare soft double-wall steel tubing with a wall thickness up to .028"
- Can also be used with soft copper and aluminum tubing
- Flares metric hydraulic brake lines used on European, Japanese and American automobiles and light trucks



OTC-4504 **\$61⁹⁵** OTC

Bubble (I.S.O.) Flaring Tool Kit

- Designed for crack-free bubble flares on soft steel tubing used in automotive brake systems
- Includes 4.75mm, 6mm, 8mm, and 10mm adapters



ATD-5464 **\$95¹⁵**

Bubble (I.S.O.) Flaring Tool Kit

- Designed for crack-free bubble flares on soft steel tubing used in automotive brake systems
- Includes 4.75mm, 6mm, 8mm, and 10mm adapters



TITAN TIT-51535 **\$96⁷⁵**

3/16" Double Flaring Tool

- Works on steel, nickel and copper tubing
- Includes double ended OP1/OP2 punch, die lubricant and positioning bolt
- Compact design allows for on-vehicle use or remove handle to mount in bench vise



A

ABRASIVES, CUTTING & GRINDING ACCESSORIES 117-125

- Arbors..... 124
- Burrs..... 120, 121, 122
- Cut-Off Wheels..... 125
- Deburring Tools..... 120
- Engine Cylinder Hones..... 120
- Flex-Hones..... 119
- Grinding Wheels..... 125
- Hand Files..... 122
- Roll-On Disc Holders..... 124
- Scratch Brushes..... 119
- Surface Preparation Discs..... 123, 124
- Wire Brushes..... 117, 118

- Absorbents..... 298
- ABS Sensor Testers..... 51
- Adapters, Cooling System..... 372, 373
- Adapters, Socket..... 159, 160
- Adapters, Universal Joint..... 159, 160
- ADAS..... 48, 49
- Adhesives & Glues..... 300
- Adjustable Wrenches..... 173

AIR COMPRESSORS & ACCESSORIES 108-110

- Air Compressors..... 108, 109
- Filter/Regulator/Lubricator Units..... 110

AIR CONDITIONING SYSTEM SERVICE 398-408

- A/C Charging Station..... 400
- A/C Oils & Injectors..... 408
- A/C Recovery Systems..... 399
- A/C Refrigerant Identifiers..... 404
- A/C Refrigerant Recovery, Recycling & Recharging Machines..... 398
- A/C Refrigerant Scales..... 400
- A/C Sealant Detectors..... 405
- A/C Sealants & Injectors..... 408
- A/C Service Tools..... 403, 404
- A/C System Flushers..... 399
- A/C Vacuum Pumps..... 403
- Electronic Leak Detectors..... 405
- Manifold Gauges..... 400, 401, 402
- Nitrogen Leak Detectors..... 405
- Service Couplers..... 402
- Spray-On Leak Detectors..... 405
- Ultraviolet Flashlights..... 406
- Ultraviolet Leak Detection..... 406, 407

- Air Lift Jacks..... 238

AIR TOOLS & ACCESSORIES 84-107

- Air Tool Maintenance..... 91
- Blow Guns..... 106, 107
- Chisels (Air Hammer)..... 97, 98, 99
- Couplers & Plugs..... 105, 106
- Cut-Off Tools..... 101
- Die Grinders..... 94, 95
- Drills..... 93
- Engravers..... 96
- Grinders..... 96
- Hammers..... 96, 97
- Impact Wrench Boots..... 91
- Impact Wrenches..... 84-90
- Impact Wrench Lifters..... 91
- Needle Scalars..... 100
- Nibblers..... 100
- Polishers..... 104
- Punch/Flange Tools..... 100
- Ratchets..... 92
- Reciprocating Saws..... 100
- Regulators..... 105
- Retainers for Air Hammers..... 99
- Sanders..... 102, 103, 104
- Scrapers..... 100
- Screwdrivers..... 93
- Shears..... 100
- Swivels..... 105
- Tire Buffers..... 104

- Angle Gauges, Torque..... 181

- Angle Measuring Devices..... 337
- Antenna Service..... 320
- Anti-Freeze Testers..... 376
- Arbors (Cut-Off Wheels)..... 124
- Assortment Sets..... 301, 302, 303
- Axle Jacks..... 237, 238
- Axle Nut Sockets..... 354
- Axle Tools..... 365, 366

B

- Back Probes..... 64, 65
- Ball Joint Separators..... 364
- Ball Joint Service Tools..... 368, 369
- Bandfiles..... 82
- Batteries..... 300
- Batteries & Chargers, Cordless Tools..... 79

BATTERY SERVICE 9-26

- Battery Chargers..... 16, 17, 18, 19, 20
- Battery & Electrical System Testers 20-23
- Battery Maintenance Tools & Access..... 26
- Battery Testers..... 24, 25
- Booster Cables..... 15
- Booster Clamps..... 15
- Boosters..... 15
- Inverters..... 25
- Jump Starters..... 12, 13
- Jump Starters / Power Banks..... 14
- Memory Savers..... 25
- Power Banks..... 14

- Bead Breakers..... 360, 361, 362
- Bead Seaters..... 362

BEARING, BUSHING & SEAL SERVICE 345-346

- Bedliner Coatings..... 317
- Bench Grinders..... 287
- Benders, Tube..... 411
- Binders..... 248
- Bit Holders..... 187
- Bits, Drill..... 126, 127
- Bit Sockets, Combination..... 166
- Bit Sockets, Female Torx® & Torx® Plus..... 161
- Bit Sockets, Hexagonal..... 164, 165
- Bit Sockets, MorTorq®..... 166
- Bit Sockets, Rib®/Polydrive..... 163
- Bit Sockets, Torx®..... 162, 163
- Bit Sockets, Torx® Plus..... 162, 163
- Bit Sockets, Triple Square/XZN..... 165, 166
- Bits, Screwdriver..... 186, 187
- Blades, Utility Knife..... 135
- Blind Hole Bearing Pullers..... 227
- Blow Guns..... 106, 107

BODY SHOP 309-320

- Antenna Service..... 320
- Body Repair Tools & Equipment..... 309, 310
- Bumper Sensor Service..... 317
- Door Tools..... 317
- Paint Guns & Accessories..... 315, 316
- Pinstripe Removers/ Surface Preparation Tools..... 314
- Plastic Welders & Accessories..... 311
- Radio Service..... 320
- Sand Blasters..... 313
- Sanding Accessories..... 313
- Spot Weld Tools & Accessories..... 313
- Spray Guns & Accessories..... 315, 316
- Stud Welders..... 312
- Upholstery, Trim & Door Panel Tools..... 318, 319
- Windshield & Window Service Tools..... 320
- Work Stands..... 316

- Bolt Cutters..... 194
- Booster Cables..... 15
- Booster Clamps..... 15
- Boosters (Battery Service)..... 15
- Boots, Impact Wrench..... 91
- Bore Gauges..... 337
- Bottle Jacks..... 234, 235
- Brake Drum Dollies..... 247

BRAKE SERVICE 338-344

- Brake Bleeders..... 338, 339
- Brake Fluid Testers..... 342
- Brake Lathe Bits..... 342
- Brake Pad, Drum & Rotor Gauges..... 343, 344
- Brake Rotor Hones..... 342
- Brake Service Tools..... 340, 341, 342
- Truck Brake Service Tools..... 342, 343

- Breaker Bars..... 159
- Brushes, Parts Washing..... 294
- Brushes, Scratch..... 119
- Brushes, Wire..... 117, 118
- Budd Wheel Sockets..... 359
- Buffers, Tire..... 104
- Burrs..... 120, 121, 122
- Bushing Service Tools..... 345-346
- Butane Fuel..... 327
- Butane Torches..... 327

C

- Cable Cutters..... 194
- Cables, Booster..... 15
- Cable Ties..... 303
- Cages, Tire Inflation..... 360
- Calipers..... 335
- Camber Adjusters..... 371
- Cameras, Thermal Imaging..... 409

CAMERAS / VIDEOSCOPIES 70

CARGO HANDLING / HOISTING EQUIPMENT 248

- Hoists/Chain Pullers..... 248
- Load Binders..... 248
- Power Pulls..... 248
- Tie-Downs/Binders..... 248

- Carts..... 221
- Center Punches..... 212
- Chain Pullers..... 248
- Chain Wrenches..... 174
- Chargers, Battery..... 16, 17, 18, 19, 20
- Chrome Sockets..... 148, 149, 150
- Circuit Testers..... 56, 57, 58
- Circular Saw Blades..... 116
- Clamps, Booster..... 15
- Cleaners/Detergents, Fuel System..... 392
- Cleaners, Metal..... 299
- Cleaning Accessories..... 292, 293
- Coatings, Bedliner..... 317
- Code Readers/Code Scanners..... 49
- Coil Spring Service Tools..... 370
- Combustible Gas Leak Detectors..... 67
- Combustion Leak Detectors..... 380
- Compression Testers..... 378
- Compression Testers, Diesel..... 379
- Compressors, Air..... 108, 109
- Contact Cleaners..... 299
- Coolant Testers..... 376
- Cooling System Adapters..... 372, 373

COOLING SYSTEM MAINTENANCE 372-376

- Anti-Freeze & Coolant Testers..... 376
- Coolant Dyes..... 376
- Cooling System Pressure Testers..... 372, 373
- Cooling System Refillers & Evacuators..... 374, 375
- Cooling System Service Tools..... 376
- Fan Clutch Wrenches..... 375
- Water Pump Tools..... 377

CORDESS & ELECTRIC TOOLS 72-83

- Bandfiles..... 82
- Batteries & Chargers, Cordless Tools..... 79
- Cut-Off Tools..... 79
- Die Grinders, Cordless..... 79
- Drill Chucks & Adapters..... 83

- Drills & Drivers, 12V..... 76
- Drills & Drivers, 18V..... 76
- Drills & Drivers, 20V..... 77
- Drills & Drivers, 60V..... 77
- Engravers..... 83
- Grinders, Cordless..... 80
- Grinders, Electric..... 80
- Impact Wrenches, 12V..... 72
- Impact Wrenches, 18V..... 73
- Impact Wrenches, 20V..... 74
- Lockbolt Tools..... 83
- Multi-Tool Kits, Cordless..... 75
- Nailers, Cordless..... 75
- Pipe Threaders..... 83
- Polishers, Cordless & Electric..... 82
- Ratchets, 12V..... 78
- Ratchets, 20V..... 78
- Rotary Hammers, Cordless..... 75
- Rotary Tools..... 83
- Sanders, Cordless & Electric..... 82
- Saws, Cordless & Electric..... 81

- Couplers & Plugs, Air..... 105, 106
- Coveralls..... 279

CREEPERS & SEATS 304-306

- Creepers..... 304, 305
- Seats..... 306

- Cribbing Blocks..... 247
- Crowfoot Wrenches..... 172
- Current Probes..... 62
- Cut-Off Tools, Air..... 101
- Cut-Off Tools, Cordless..... 79
- Cut-Off Wheels..... 125
- Cutters, Hose..... 202
- Cutters, Tubing..... 411
- Cutting Pliers..... 192
- CV Boot Clamp Pliers..... 202
- CV Boots..... 371

D

- Deburring Tools..... 120

DEF SERVICE & MAINTENANCE 394-395

- Dent Pullers..... 233
- Depth Gauges..... 337

DIAGNOSTIC & TESTING SERVICE TOOLS 43-69

- ABS Sensor Testers..... 51
- ADAS..... 48, 49
- Back Probes..... 64, 65
- Circuit Testers/Volt Testers..... 56, 57, 58
- Code Readers/Code Scanners..... 49
- Combustible Gas Leak Detectors..... 67
- Current Probes..... 62
- Fuse/Relay Testing..... 63
- Heavy-Duty Truck & Trailer Diagnostics & Testing..... 52, 53, 54
- Key Programming..... 46
- Leak & Defect Detector..... 67
- Leak Detection Smoke Machines..... 68
- Multimeters..... 59, 60, 61
- Noid Light Testers..... 69
- Refractometers..... 69
- Scan Tools & Accessories..... 43, 44, 45
- Spark/EFI/AC Testers..... 69
- Stethoscopes..... 67
- Tachometers..... 69
- Terminal Release Tools..... 64
- Test Leads & Adapters..... 65, 66
- Timing Lights..... 69
- TPMS Diagnostic & Service Tools..... 50, 51
- Trailer Testers & Maintenance Tools..... 55
- Wheel Alignment & ADAS Calibration..... 48
- Wire Installation Tools..... 66

- Die Grinders, Air..... 94, 95
- Die Grinders, Cordless..... 79
- Diesel Compression Testers..... 379
- Diesel Engine Tools..... 387, 388
- Diesel Injector Service Tools..... 389, 390

DETAILED INDEX

Diesel System Service	389-393
Disc Holders, Roll-On	124

DISCONNECT TOOLS 410

Discs, Surface Preparation	123, 124
Dispensers, Oil	266
Disposable Gloves	277
Distance Meters	334
Dollies, Brake Drum	247
Dollies, Drum	253
Dollies, Vehicle Positioning	245
Dollies, Wheel	245, 246, 247
Door Panel Tools	318, 319
Door Tools	317
Double Box Wrenches	170
Drain Plug Tools, Oil	270, 271

DRILL BITS, STEP DRILL BITS, FASTENER EXTRACTORS 126-131

• Drill Bits	126, 127
• Fastener Extractors	129
• Step Drill Bits	128
• Stud Pullers	131
Drill Chucks & Adapters	83
Drill Gauges	337
Drill Presses	286
Drills, Air	93
Drills & Drivers, 12V	76
Drills & Drivers, 18V	76
Drills & Drivers, 20V	77
Drills & Drivers, 60V	77
Drivers, Bit	185
Drivers, Hose Clamp	185
Drivers, Impact	184
Drivers, Nut	185
Drum Dollies	253
Drum Gauges	343, 344
Drum Wrenches	253
Dyes, Coolant	376
Dyes, Multi-Purpose	380

E

Earmuffs	276
Ear Plugs	276
EFI Testers	69
EGT Sensor Sockets	384
Electrical System Testers	20, 21, 22, 23
Electrical Tapes	300

ELECTRIC & HYBRID VEHICLE SAFETY SOLUTIONS 137-143

• EV & HEV Service Tools & Equip. 137-142	
• Personal Protective Equipment.. 142, 143	
Electrician's Pliers	199
End Lift Jacks	238
Engine Cylinder Hones	120
Engine Lifting Equipment & Access.....	242, 243

ENGINE SERVICE TOOLS 377-388

• Combustion Leak Detectors	380
• Compression Testers	378
• Diesel Compression Testers	379
• Dyes (Multi-Purpose)	380
• Feeler Gauges	383
• Heavy-Duty Truck Diesel Engine Tools	387, 388
• Remote Control Starter Switch	383
• Sensor Sockets	384
• Serpentine Belt Tools	377
• Spark Plug & Glow Plug Tools ...	381-383
• Spark Testers	383
• Specialty Tools	383
• Special Use Pressure Testers	379, 380
• Timing Belt Tools	385, 386
• Timing Chain Tools	385, 386
• Turbo System Leakage Testers	380
• Water Pump Tools	377

Engravers, Air	96
Engravers, Electric	83
Evacuators, Cooling System	374, 375
EVAP Leak Detectors	68

EXHAUST 307-308

• Exhaust Service Tools	307
• Garage Exhaust Solutions	307
• Manifold Service Tools	308
• Tailpipe Stretchers	308
Extension Cords & Cord Reels	288, 289
Extensions, Chrome & Impact	158
Extensions, Torque Limiting	352, 353
Extractors, Fastener	131
Eye Protection	275

F

Face Shields/Visors	274
Fan Clutch Wrenches	375
Fans	283
Fastener Extractors	131
Feeler Gauges	383
Files, Hand	122
Filters, Air Compressor Line	110
Fire Style Pumps	250
Flameless Torches	325, 326
Flange Tools, Air	100
Flare Nut Wrenches	171
Flaring Tools	412
Flex Handles	159
Flex-Hones®	119
Floor Jacks	235, 236, 237
Floor Mats	297
Fluid Extractors/Dispensers	255
Fluid Extractors/Dispensers, DEF	395

FLUIDS & FUEL HANDLING 249-259

• Chemical Pumps	250
• Drum Dollies	253
• Drum Wrenches	253
• Fluid Extractors/Dispensers	255
• Fluid Refilling Systems	254, 255
• Fuel Storage & Transfer Caddies	259
• Gas Caddies	259
• Gas/Diesel Pumps & Access	256-258
• High Pressure Fire Style Pumps	250
• Multi-Fluid Pumps	251, 252, 253
• Semi-Trash & Trash Pumps	250
• Static Discharge/Grounding Reels	259
• Water Transfer Pumps	249, 251
Foot Pumps	240

FRONT-END & SUSPENSION 363-371

• Axle/Spindle & Locknut Tools ...	365, 366
• Ball Joint Separators	364
• Ball Joint Service Tools	368, 369
• Camber Adjusters	371
• CV Boots	371
• King Pin Service	365
• Leaf Spring Service	371
• Lower Control Arm Tools	371
• Pitman Arm & Tie Rod Tools	363, 364
• Power Steering Service Tools	365
• Strut & Coil Spring Service Tools	370
• Suspension Wear Indicators	371
• Sway Bar Link Tools	369
• Tie Rod Separators	364
• Torsion Bar Tools	368
• Wheel Hub Service Tools	367, 368

FUEL & DIESEL SYSTEM SERVICE 389-393

• Diesel Fuel Hydrometers	391
• Diesel Injector Service Tools	389, 390
• Fuel Filter Sockets & Wrenches	392
• Fuel Injection Cleaners	392
• Fuel Injection Pressure Testers	393
• Fuel Injector Service Tools	391
• Fuel Line Service Tools	391
• Fuel Pump Tools	391
• Fuel System Cleaners/Detergents	392
• Fuel System Testers	393
• Fuel Tank Tools	391
Funnels, Oil	266
Fuse Testers	63

G

Gaiters, Neck	274
Gas Caddies	259
Gasket Hole Punches	212
Gas Leak Detectors	67
Gauges, Angle	337
Gauges, Bore	337
Gauges, Brake Pad	343, 344
Gauges, Caliper	335
Gauges, Depth	337
Gauges, Drill	337
Gauges, Drum	343, 344
Gauges, Feeler	383
Gauges, Micrometer	336
Gauges, Rotor	343, 344
Gauges, Spark Plug Gap	383
Gauges, Tire Pressure	348, 349, 350
Gauges, Torque Angle	181, 337
Gauges, Tread Depth	350
Generators	281
Generators/Inverters	282
Gland Nut Wrench	174
Glasses, Safety	275
Gloves, Disposable	277
Gloves, Welding	333
Gloves, Work	278, 279
Glow Plug Tools	381, 382, 383
Glue Guns	300
Glues & Adhesives	300
Grinders, Air	96
Grinders, Bench	287
Grinders, Cordless	80
Grinders, Electric	80
Grinding Wheels	125
Grounding Reels	259

H

Hacksaw Blades	116
Hacksaws	116

HAMMERS 207-209

• Ball Pein Hammers	207
• Cross Pein Hammers	209
• Dead Blow Hammers	208
• Drilling Hammers	208
• Mixed Hammer Sets	209
• Non-Sparking Brass Hammers	209
• Rubber Mallets	207
• Sledge Hammers	207

Hammers, Air	96, 97
Hammers, Welding	332
Hand Files	122
Hand Trucks	290
Head Light Aligners	287
Hearing Protection	276
Heaters	284

HEAT GUNS / FLAMELESS HEAT TOOLS / TORCHES 324-327

• Butane Fuel	327
• Butane Torches	327
• Heat Guns	324
• Induction Heaters	325, 326
• Propane Torches	326

Helmets, Welding	333
Hexagonal Bit Sockets	164
Hex Wrenches (Fold Up)	177
Hex Wrenches (L-Shaped)	176, 177
Hex Wrenches (T-Shaped)	176, 177
Hoists, Chain	248
Hole Punch	212
Hole Saws	116
Hollow Punches	212
Hones, Brake Rotor	342
Hones, Engine Cylinder	120
Honing Brushes	119
Hood Props	289

HOOKS & PICKS 214

• Hooks & Picks	214
• Seal Pullers	214

Hose Clamp Drivers	185
Hose Clamp Pliers	200, 201
Hose Cutters	202
Hose Grip Pliers	202
Hose Pinching Pliers	201
Hose Reels for Oil & Grease	273
Hose Reels for Oxygen/Acetylene	332
Hose Release Pliers	202

HOSES & ACCESSORIES 111-114

• Air Hose Holders	114
• Air Hoses	111, 112
• Air/Water Hoses	112, 113
• Hose Fittings	114
• Hose Nozzles	114
• Water Hoses	114

Hub Resurfacing Tools	358
HVAC Fabrication Snips/Tools	195
Hydrometers, Diesel Fuel	391

I

IAC Testers	69
Impact Drivers	184
Impact Sockets	151-157
Impact Sockets, Special Application	152, 155
Impact Sockets, Universal	155
Impact Wrenches, 12V	72
Impact Wrenches, 18V	73
Impact Wrenches, 20V	74
Impact Wrenches, Air	84-90
Impact Wrench Lifters	91
Indicator Sets	336
Induction Heaters	325, 326
Inflation Cages	360
Infrared Thermometers	409
Injector Service Tools, Diesel	389, 390
Injector Service Tools, Fuel	391

INSPECTION & PICK-UP TOOLS 71

• Inspection Mirrors	71
• Magnifiers	71
• Pick-Up Tools	71
Insulated Tools & Equipment	137-142
Insulating Personal Protective Equip. ..	142, 143
Inverter Generators	282
Inverters	25

J

Jacks, Off-Road/Manual	238
Jack Stands	239, 240
Jacks, Transmission	241, 242
Janitorial Supplies	297
Jig Saw Blades	116
Jimmy Bars	211
Jump Starters	12, 13
Jump Starters / Power Banks	14

K

Key Programming	46
King Pin Service	365
Knee Pads	275

KNIVES, SCISSORS & ACCESSORIES 135-136

• Scissors & Shears	136
• Utility Knife Refill Blades	135
• Utility Knives	135, 136

L

Lathe Bits, Brake	342
Leaf Spring Service	371
Leak Detection Smoke Machines	68
Leak Detection, Ultraviolet	406, 407
Leak Detectors, A/C Service	405
Leak Detectors, Combustible Gas	67

Leak Detectors, Combustion	380
Leak Detectors, Nitrogen	405
Leak Detectors, Spray-On	405
Levels	335

LIFTING EQUIPMENT 234-247

• Air/Hydraulic Axle Jacks	237, 238
• Air Lift Jacks	238
• Bottle Jacks	234, 235
• Brake Drum Dollies	247
• Cribbing & Safety	247
• End Lift Jacks	238
• Engine Lifting Equip. & Access. ..	242, 243
• Floor Jacks	235, 236, 237
• Foot Pumps	240
• Jack Stands	239, 240
• Lifting Jack Pads	247
• Off-Road/Manual Jacks	238
• Rams & Accessories	240
• Tire Carts	245, 246
• Trailer Stabilizing Stands	244
• Transmission Jacks	241, 242
• Truck Ramps	245
• Under Hoist Stands	244
• Vehicle Positioning Dollies	245
• Wheel Dollies	245, 246, 247

LIGHTING 27-42

• Flashlights, Non-Rechargeable	40
• Flashlights, Rechargeable	38, 39
• Headlamps	41, 42
• Lanterns/Utility Lights	34
• Light Holders	38
• Neck Lights	42
• Penlights/Pocket-Size Lights ..	36, 37, 38
• Replacement Light Bulbs	29
• Underhood Lights	35
• Work Lights	27-34

Lineman's Pliers	199
Load Binders	248
Lockbolt Tools	83
Locking Pliers	205, 206
Locknut Tools	354, 365, 366

LOCK-OUT TOOLS & ACCESSORIES 396-397

Lower Control Arm Tools	371
Lubricants (Anti-Corrosion/Multipurpose) ..	299

LUBRICATION 260-273

• Air-Operated Grease Guns	261
• Battery-Operated Grease Guns	261
• Bearing Packers	263
• Grease Accessories	262
• Grease Pumps	273
• Hose Reels for Oil & Grease	273
• Lube Meters	271
• Manual Grease Guns	260
• Oil Dispensers	266
• Oil Drain Plug Tools	270, 271
• Oil Drains & Pans	263, 264, 265
• Oil Filter Pliers, Sockets & Wrenches	267-270
• Oil Funnels	266
• Oil Pumps	272

Lubricators, Air Compressor Line	110
Lug Bolt Tools	355, 356
Lug Nut Tools	355, 356

M 225-256

Magnetic Parts Holder	225
Magnetic Parts Trays	225
Magnetic Pick-Up Tools	71
Magnetic Tool Holder	224
Magnets	289
Manifold Gauges	400, 401, 402
Manifold Service Tools	308
Markers, Industrial	299
Masks	274

MEASURING & PRECISION INSTRUMENTS 334-337

• Angle Measuring Devices	337
• Bore Gauges	337
• Calipers	335
• Depth Gauges	337
• Distance Meters	334
• Drill Gauges	337
• Indicator Sets	336
• Levels	335
• Measuring Tapes	334
• Micrometers	336
• Straight Edges	334
• Torque Angle Gauges	337

Memory Savers	25
Metal Polishes/Cleaners	299
Meters, Lube	271
Micrometers	336
Mirrors	71
MorTor® Bit Sockets	166
Multimeters	59, 60, 61

N 75-185

Nailers, Cordless	75
Neck Gaiters	274
Needle Scalers, Air	100
Nibblers, Air	100
Nitrogen Leak Detectors	405
Noid Light Testers	69
NOx Sensor Sockets	384
Nozzles, Hose	114
Nut Drivers	185
Nut Setters	185

O 91-384

Oiler for Air Tools	91
Oils & Injectors (A/C)	408
Organizers, Tool	222, 223, 224, 225
Oxygen/Acetylene Hose Reels	332
Oxygen Sensor Sockets	384

P 275-316

Pads, Knee	275
Paint Guns & Accessories	315, 316
Paint Pens	299
Parts Holder, Magnetic	225
Parts Trays, Magnetic	225
Parts Wash Brushes	294
Parts Washers	294
Pedal Depressors	289
Pentagonal Bit Sockets	163
Personal Protective Equipment (EV & HEV Service)	142, 143
Picks	214
Pick-Up Tools	71
Pinstripe Removers	314
Pipe Plug Sockets	152
Pipe Threaders	83
Pipe Wrenches	175
Pitman Arm Tools	363, 364
Plastic Welders & Accessories	311

PLIERS 188-206

• Adjust./Tongue & Groove Pliers ..	189-191
• Bolt Cutters	194
• Cable Cutters	194
• Cutting Pliers	192
• CV Boot Clamp Pliers	202
• Hose Clamp Pliers	200, 201
• Hose Cutters	202
• Hose Grip Pliers	202
• Hose Pinching Pliers	201
• Hose Release Pliers	202
• HVAC Fabrication Snips/Tools	195
• Lineman's/Electrician's Pliers	199
• Locking Pliers	205, 206
• Long Nose/Needle Nose Pliers	193
• Mixed Pliers	188, 189
• Retaining & Snap Ring Pliers ..	203, 204
• Slip Joint Pliers	189
• Snips	195

• Welding Pliers	202
• Wire Strip/Cut/Crimp Pliers	196-198

Pliers, Oil Filter	267, 268, 269, 270
Plugs, Air	105, 106
Pocket Thermometers	409
Polishers, Air	104
Polishers, Cordless & Electric	82
Polish, Metal	299
Polydrive Bit Sockets	163
Power Banks	14
Power Cord Reels	288, 289
Power Pulls	248
Power Steering Service Tools	365
Power Tools	72
Precision Instruments	334-337
Presses & Accessories	286
Pressure Testers, Cooling System	372, 373
Pressure Testers, Fuel Injection	393
Pressure Testers, Special Use	379, 380
Pressure Washers	280, 281
Probes, Current	62
Propane Torches	326
Protective Coatings	317
Protractors	337

PRY BARS 210-211

• Indexing Pry Bars	211
• Jimmy / Line-Up Pry Bars	211
• Rolling Head Pry Bars	211
• Screwdriver Pry Bars	210

PULLERS 226-233

• Battery Terminal Pullers	233
• Blind Hole Bearing Pullers	227
• Dent Pullers	233
• Drum & Rotor Pullers	230
• Flange-Type Pullers	228
• Gear, Bearing & Pulley Pullers / Splitters	226, 227
• Harmonic Balancer Pullers	230
• Pitman Arm Pullers	233
• Power Steering & Alternator Pulley Pullers	229
• Slack Adjuster Pullers	231
• Slide Hammer Pullers	228
• Steering Wheel/Column Pullers	229
• Tie Rod Pullers	233
• U-Joint Pullers	231
• Wheel Hub Pullers	232
• Wiper Arm Pullers	233
• Yoke Pullers	232

Pullers, Seal	214
Pullers, Stud	131
Pumps, Chemical	250
Pumps, DEF Transfer	394
Pumps, Fire Style	250
Pumps, Foot	240
Pumps, Gas/Diesel	256, 257, 258
Pumps, Grease	273
Pumps, Multi-Fluid	251, 252, 253
Pumps, Oil	272
Pumps, Trash	250
Pumps, Water Transfer	249, 251

PUNCHES & CHISELS 212-213

Punch/Flange Tools, Air	100
-------------------------------	-----

R 320-324

Radio Service	320
Rags	297
Ramps, Truck	245
Rams & Accessories	240

RATCHETS 144-147

• 1/4" Square Drive Ratchets	147
• Extendable Ratchets	147
• Fixed Head Ratchets	144, 145
• Flex Head Ratchets	145, 146
• Mixed Ratchet Sets	145
• Rotating Head Ratchets	146

Ratchets, 12V	78
Ratchets, 20V	78

Ratchets, Air	92
Reciprocating Saw Blades	115
Reciprocating Saws, Air	100
Reels, Power Cord	288, 289
Reels, Static Discharge/Grounding	259
Refillers, Cooling System	374, 375
Refractometers	69, 395
Refrigerant Identifiers	404
Refrigerant R/R/R Machines	398
Refrigerant Scales	400
Regulators, Air Compressor Line	110
Regulators, Air Tool Side	105
Relay Testers	63
Respirators	274
Resurfacing Tools, Hub	358
Resurfacing Tools, Stud	358
Retainers, Air Hammer	99
Retaining Ring Pliers	203, 204
Ribe®/Polydrive Bit Sockets	163

RIVETERS 321-323

• Air Riveters	321
• Cordless Riveters	322
• Hand Riveters	322, 323
• Power Riveting Adapters	323

Rotary Tools	83
Rotor Gauges	343, 344

S 274-279

SAFETY PRODUCTS / PPE 274-279

• Coveralls	279
• Disposable Gloves	277
• Eye Protection	275
• Face Shields	274
• Hearing Protection	276
• Knee Pads	275
• Masks	274
• Neck Gaiters	274
• Respirators	274
• Safety Glasses	275
• Visors	274
• Work Gloves	278, 279

Sand Blasters	313
Sandblasting/Abrasive Equipment	294
Sanders, Air	102, 103, 104
Sanders, Cordless & Electric	82
Sanding Accessories	313

SAW BLADES & SAWS 115-116

• Circular Saw Blades	116
• Hacksaw Blades	116
• Hole Saws	116
• Jig Saw Blades	116
• Reciprocating Saw Blades	115

Saws, Air Reciprocating	100
Saws, Cordless & Electric	81
Scales, A/C Refrigerant	400
Scan Tools & Accessories	43, 44, 45
Scissors	136

SCRAPERS 134

• Carbon Scrapers	134
• Plastic Scrapers	134
• Razor Scrapers	134
• Stainless Steel Scrapers	134

Scrapers, Air	100
Scratch Brushes	119
Screwdrivers, Air	93

SCREWDRIVERS & SCREWDRIVER BITS 182-187

• Bit Drivers	185
• Bit Holders	187
• Bit Sets	186, 187
• Hose Clamp Drivers	185
• Impact Drivers	184
• Multi-Bit Screwdrivers	183, 184
• Nut Drivers/Sut Setters	185
• Screwdriver Sets	182, 183
• Torque Screwdrivers	184

DETAILED INDEX

Screwdrivers, Torque.....	181
Sealant Detectors (A/C).....	405
Sealants & Injectors (A/C).....	408
Seal Pullers.....	214
Seal Service Tools.....	345-346
Seat Covers.....	297
Seats.....	306
Sensor Sockets.....	384
Serpentine Belt Tools.....	377
Shears.....	136
Shears, Air.....	100
Shop Presses & Accessories.....	286

SHOP TOOLS, EQUIPMENT & SUPPLY 280-303

• Adhesives.....	300
• Assortment Sets.....	301, 302, 303
• Batteries.....	300
• Bench Grinders.....	287
• Cable Ties.....	303
• Clamps.....	285
• Cleaning Accessories.....	292, 293
• Contact Cleaners.....	299
• Drill Presses.....	286
• Dyes (Multi-Purpose).....	380
• Electrical Tapes.....	300
• Extension Cords & Cord Reels... ..	288, 289
• Fans.....	283
• Generators.....	281
• Glue Guns.....	300
• Glues.....	300
• Hand Trucks.....	290
• Head Light Aligners.....	287
• Heaters.....	284
• Hood Props.....	289
• Inverter Generators.....	282
• Janitorial Supplies.....	297
• Lubricants.....	299
• Magnets.....	289
• Metal Polishes/Cleaners.....	299
• Outdoor Power Equipment.....	296
• Paint Pens.....	299
• Parts Wash Brushes.....	294
• Parts Washers.....	294
• Pedal Depressors.....	289
• Presses & Accessories.....	286
• Pressure Washers.....	280, 281
• Protective Coatings.....	317
• Rags & Towels.....	297
• Sandblasting/Abrasive Equipment	294
• Seat Covers & Floor Mats.....	297
• Spill Absorbents.....	298
• Sprayers.....	292, 293
• Stools & Platforms.....	290
• Threadlockers.....	300
• Tire Steps.....	290
• Vacuum Cleaners.....	295, 296
• Vises.....	285
• Workbenches.....	291
• Work Stands.....	291

Slack Adjuster Pullers.....	231
Slide Hammer Pullers.....	228
Smoke Machines (Leak Detection).....	68
Snap Ring Pliers.....	203, 204
Snips.....	195
Sockets, Axle Nut.....	354

SOCKETS, BIT SOCKETS & ACCESSORIES 148-166

• Breaker Bars.....	159
• Chrome Sockets.....	148, 149, 150
• Combination Bit Socket Sets.....	166
• Extensions.....	158
• Extra-Deep Specialty Sockets.....	150
• Female Torx® & Female Torx Plus® Bit Sockets.....	161
• Flex Handles.....	159
• Flex Head Sockets.....	150
• Hexagonal Bit Sockets.....	164, 165
• Impact Sockets.....	151, 152, 153, 154
• MorTorq® Bit Sockets.....	166
• Open Stock Impact Sockets.....	156, 157
• Pentagonal Bit Sockets.....	163
• Pipe Plug Sockets.....	152
• Ribe®/Polydrive Bit Sockets.....	163
• Socket Adapters.....	159, 160

• Special Application Sockets.....	155
• Torx® & Torx Plus® Bit Sockets... ..	162, 163
• Triple Square/XZN Bit Sockets... ..	165, 166
• Universal Impact Sockets.....	155
• Universal Joint Adapters.....	159, 160
• Vocational / Mechanics Tool Sets.....	150

Sockets, Budd Wheel.....	359
Sockets, Fuel Filter.....	392
Sockets, Oil Filter.....	267, 268, 269, 270
Sockets, Tap.....	133
Sockets, Torque Limiting.....	352, 353
Socket Trays.....	222
Soldering Equipment & Accessories... ..	328-333
Soot Sensor Sockets.....	384
Spark Plug Tools.....	381, 382, 383
Spark Testers.....	69, 383
Spill Absorbents.....	298
Spindle Tools.....	365, 366
Spot Weld Tools & Accessories.....	313
Sprayers.....	292, 293
Spray Guns & Accessories.....	315, 316
Stands, Trailer Stabilizing.....	244
Stands, Under Hoist.....	244
Stands, Work.....	291, 316
Starter Switch, Remote Control	383
Static Discharge/Grounding Reels.....	259
Steering Service.....	363-371
Steering Wheel/Column Pullers.....	229
Step Drill Bits.....	128
Steps, Tire.....	290
Stethoscopes.....	67
Stools.....	290
Straight Edges.....	334
Strap Wrenches.....	174
Strut Service Tools.....	370
Stud Pullers.....	131
Stud Resurfacing Tools.....	358
Stud Welders.....	312
Suction Guns.....	255
Surface Preparation Discs.....	123, 124
Surface Preparation Tools.....	314
Surge Protectors.....	332
Suspension Service.....	363-371
Sway Bar Link Tools.....	369
Swivels, Air.....	105

T

Tachometers.....	69
Tailpipe Stretchers.....	308
Tap & Die.....	132
Tapes, Electrical.....	300
Tap Sockets.....	133
Tap Wrenches.....	132
Technical Education Tool Sets.....	150
Terminal Release Tools.....	64
Testers, ABS Sensor.....	51
Testers, Anti-Freeze.....	376
Testers, Battery.....	20-25
Testers, Brake Fluid.....	342
Testers, Circuit.....	56, 57, 58
Testers, Compression.....	378
Testers, Coolant.....	376
Testers, Diesel Compression.....	379
Testers, EFI.....	69
Testers, Electrical System.....	20, 21, 22, 23
Testers, Fuel System.....	393
Testers, IAC.....	69
Testers, Noid Light.....	69
Testers, Pressure.....	379, 380
Testers, Spark.....	69, 383
Testers, Turbo System Leakage.....	380
Testers, Volt.....	56, 57, 58
Testing Service Tools.....	43-69
Test Leads & Adapters.....	65, 66
Test Tanks, Tire & Tube.....	350
Thermal Imaging Cameras.....	409

THERMOMETERS 409

• Infrared Thermometers.....	409
• Pocket Thermometers.....	409
• Thermal Imaging Cameras.....	409
• Wireless Thermometers.....	409

THREADING 132-133

• Specialty Rethreaders.....	133
• Tap & Die.....	132
• Tap Sockets.....	133
• Tap Wrenches.....	132
• Thread Restoring Tools.....	133
Threadlockers.....	300
Tie-Downs.....	248
Tie Rod Pullers.....	233
Tie Rod Separators.....	364
Tie Rod Tools.....	363, 364
Tie Wraps.....	303
Timing Belt Tools.....	385, 386
Timing Chain Tools.....	385, 386
Timing Lights.....	69
Tire Buffers.....	104
Tire Carts.....	245, 246
Tire Racks.....	360
Tire Steps.....	290

TOOL STORAGE & ACCESSORIES 215-225

• Service Carts.....	221
• Tool Belts.....	225
• Tool Organizers.....	222-225
• Tool Storage.....	215-219
Torches, Butane.....	327
Torches, Flameless.....	325, 326
Torches, Propane.....	326
Torque Angle Gauges.....	337
Torque Limiting Extensions & Sockets	352, 353
Torque Screwdrivers.....	184

TORQUE TOOLS 178-181

• Torque Angle Gauges.....	181
• Torque Meters.....	181
• Torque Multipliers.....	181
• Torque Screwdrivers.....	181
• Torque Testers.....	181
• Torque Wrenches.....	178, 179, 180, 181
Torsion Bar Tools.....	368
Torx® Bit Sockets, Female.....	161
Torx® & Torx Plus® Bit Socket Sets	162, 163
Towels.....	297
TPMS Diagnostic & Service Tools.....	50, 51
TPMS Service Tools.....	351
Trailer Stabilizing Stands.....	244
Trailer Testers & Maintenance Tools.....	55
Transfer Punches.....	213
Transmission Fluid Refilling Systems... ..	254, 255
Transmission Jacks.....	241, 242
Trash Pumps.....	250
Trim Tools.....	318, 319
Triple Square/XZN Bit Sockets.....	166
Truck Ramps.....	245

TUBING & FLARING TOOLS 411-412

• Flaring Tools.....	412
• Tube Benders.....	411
• Tube Cutters.....	411
Turbo System Leakage Testers.....	380

U

Ultraviolet Flashlights.....	406
Ultraviolet Leak Detection.....	406, 407
Under Hoist Stands.....	244
Universal Joint Adapters.....	159, 160
Unlocking Tools & Accessories.....	396-397
Upholstery Tools.....	318, 319
Utility Knives.....	135, 136

V

Vacuum Cleaners.....	295, 296
Vacuum Pumps.....	403
Valve Service Tools.....	351
Vehicle Positioning Dollies.....	245
Videoscopes (Inspection).....	70
Vises.....	285
Visors.....	274
Volt Testers.....	56, 57, 58

Water Pump Tools.....	377
Water Transfer Pumps.....	249, 251
Welders, Plastic.....	311
Welders, Stud.....	312
Welding Pliers.....	202

WELDING & SOLDERING 328-333

• Oxygen/Acetylene Hose Reels.....	332
• Soldering Guns.....	329
• Soldering Irons.....	328, 329
• Surge Protectors.....	332
• Welding Clamps & Aids.....	332
• Welding & Cutting Equipment	330, 331
• Welding Gloves.....	333
• Welding Hammers.....	332
• Welding Helmets.....	333
Wheel Dollies.....	245, 246, 247
Wheel Hub Service Tools.....	367, 368

WHEEL & TIRE MAINTENANCE 347-362

• Axle Nut/Locknut Tools.....	354
• Bead Seaters.....	362
• General Service Tools.....	354
• Heavy-Duty Wheel Service Tools.....	359
• Hub & Stud Resurfacing Tools.....	358
• Inflation Cages.....	360
• Inflators & Gauges.....	348, 349, 350
• Lug Nut, Lug Bolt & Wheel Lock Tools.....	355, 356
• Tire Changers.....	347
• Tire Changing Tools & Equip.	360-362
• Tire Racks.....	360
• Tire Repair.....	351
• Tire & Tube Test Tanks.....	350
• Torque Limiting Exten. & Sockets	352, 353
• Tread Depth Gauges.....	350
• Valve & TPMS Service Tools.....	351
• Wheel Alignment Tools.....	359
• Wheel Balancers.....	347
• Wheel Guards for Trucks.....	359
• Wheel Stud Service Tools.....	357
• Wheel Weight Tools.....	359

Windshield & Window Service Tools.....	320
Wire Brushes.....	117, 118
Wire Installation Tools.....	66
Wireless Thermometers.....	409
Wire Strip/Cut/Crimp Pliers.....	196, 197, 198
Workbenches.....	291
Work Gloves.....	278, 279
Workshop Tools, Equipment & Supply	280-303
Work Stands.....	291, 316

WRENCHES 167-177

• Adjustable Wrenches.....	173
• Chain Wrenches.....	174
• Comb. Non Ratcheting Wrenches.....	167, 168
• Comb. Ratcheting Wrenches.....	168, 169
• Crowfoot Wrenches.....	172
• Double Box Wrenches.....	170
• Flare Nut Wrenches.....	171
• Fold Up Wrenches.....	177
• Gland Nut Wrench.....	174
• L-Shaped Wrenches.....	176, 177
• Open End Wrenches.....	171
• Pipe Wrenches.....	175
• Special Application Wrenches.....	174
• Strap Wrenches.....	174
• T-Handle Wrenches.....	176, 177
• Wrench Accessories.....	174

Wrenches, Drum.....	253
Wrenches, Fan Clutch.....	375
Wrenches, Fuel Filter.....	392
Wrenches, Oil Filter.....	267, 268, 269, 270
Wrenches, Tap.....	132
Wrenches, Torque.....	178, 179, 180, 181
Wrench Racks.....	223

X

XZN Bit Sockets.....	165, 166
----------------------	----------

SUPER Liquidation



FINAL SALE



MTC-52225-MED **\$29⁴⁵**

Multi-Function Medical/Surface Non-Contact Infrared Thermometer

- Temperature range: **Forehead mode:** 34°C to 42.2°C (93.2°F to 108°F)
Surface mode: -22°C to 80°C (-7.6°F to 176°F)
- Includes (2) AAA batteries



ATQ-OBD5-M000 **\$49⁹⁵**

MitsuReset Universal TPMS Sensor Decoder

- Enables TPMS relearn mode on most Mitsubishi Lancer, Outlander, Outlander Sport, RVR and Mirage
- The MitsuReset can be used together with the ATEQ VT56 TPMS diagnostic tool, VT55 TPMS diagnostic tool, VT30 TPMS reset tool, the VT15 TPMS activation tool or any other trigger tool
- Replaces the OEM scan tool
- Free lifetime software updates



SGT-28000 **\$9⁹⁵**

Heavy Duty Automotive Logic Probe Circuit Tester for 6/12/24V Systems

- Quickly and safely test high and low voltages (power and ground) on all vehicle circuits, including computerized engine and body controls



ATD-5845 **\$99⁹⁵**

12" Nut/Thread Hand Riveter Kit

- (1 each) Metric nosepieces: M5, M6 and M8
- (1 each) SAE nosepieces: 10-24, 1/4"-20 and 5/16"-18
- (10 each) rivet nuts: M5, M6, M8, 10-24, 1/4"-20 and 5/16"-18

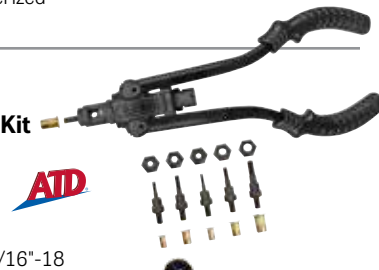

TBQ-912 **\$443⁵⁵**

The Ultimate Hub Puller

- Removes press fit wheel bearings in seconds
- Works on foreign and domestic cars, vans and trucks
- Sliding weight of approximately 15 lbs



ATD-5289 **\$749⁸⁵**

Air Operated High-Pressure Grease Pump for 25-50 lbs Pails

- 50:1 heavy-duty double acting pump
- 6 ft. high-pressure hose, pump muffler, Lincoln-style air coupler, drum cover
- Follower plate with rubber wiping rings to fit CONICAL pails
- Grease strainer screen
- Output: 80 cu.in./min.
- Air inlet: 1/8" NPT(f)
- Lube outlet: 1/4" NPT(f)



TDF-213045 **\$34⁹⁵**

Plastic Welding Accessory Kit

- Ideal for welding and repairing plastic parts and components
- Includes:
 - 10mm plastic welding head
 - Precision screwdriver
 - Wire brush
 - Cleaning rod
 - Stainless steel reinforcing mesh
 - TradeFlame welding rods: (3) white & (3) black, 17cm long x 4mm OD, in each of PE, PP, PS, ABS materials



SHM-SL175RU **\$149⁴⁵**

360° SMD LED Portable Rechargeable Work Light

- 72 super-bright SMD LEDs
- High/Med/Low, up to 3,000 lumens
- Flexible 360° swivel and tilt



SHM-SL189U **\$14⁹⁵**

12V Rechargeable LED Torch

- 120 Lumens
- Runs 4 hrs/charge
- High, Low and Flash settings
- Plugs directly into vehicles
- Rechargeable 7.4V 4Ah lithium ion battery
- 12V outlet for recharging



KET-KEFL68 **\$29⁴⁵**

500 Lumens Aluminum LED Flashlight

- ANSI FL1 rated & IPX4 rated
- The diffusing lens offers greater beam distance with side visibility
- O-Ring sealed protects against dust & moisture

Kit Includes:

- Nylon pouch
- Hand Strap
- (3 AAA) Alkaline batteries



AST-40HUVL **\$59⁹⁵**

Rechargeable Handheld Light with a UV Top Light

- 0-400 lumens COB LED light
- UV top light for A/C and fluid dye leak detection
- High/Low: 4/11 hrs
- Includes wall adapter and micro USB cable

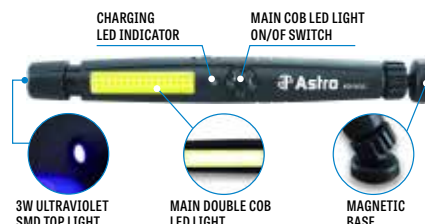

SUPER Liquidation



FINAL SALE

ACA-809-SH **\$129⁴⁵**

3/8" Drive Sealed Flat Head Air Ratchet
• 650 ft-lb • 350 RPM



SUNEX[®] TOOLS

SUN-SX113 **\$22³⁵**

3/8" Drive Air Ratchet
• 10-45 ft-lb • 150 RPM



IRWIN

IRW-IWAF1334 **\$79⁹⁵**

34-Pc Impact Screwdriver Bit Set

- Socket adapters: 1/4", 3/8", 1/2"
- Magnetic nut drivers: 1/4", 5/16", 3/8"
- 1/4" bit holders: 2.5" & 6" long
- Torx bits:**
- 2" long: T10, T15, T20, T27, T30, T40
- 3.5" & 6" long: T15, T20, T25, T27, T30
- Phillips bits:**
- 2", 3.5" & 6" long: #1, #2, #3



ATD-6404 **\$99⁴⁵**

11-Pc 3/4" Drive 6 Point Truck Service Impact Socket Set

- (10) 6 pt. sockets: 3/4", 13/16", 7/8", 15/16", 1", 1-1/16", 1-1/8", 1-3/16", 1-1/4", 1-1/2"
- (1) square drive socket: 13/16"
- Packed in metal box



TIT-16137 **\$9⁹⁵**

13-Pc 1/4" & 3/8" Drive Tamper Resistant 5-Lobe Star Bit Socket Set

- TR8, TR10, TR15, TR20, TR25, TR27, TR30, TR40, TR45, TR50, TR55



TIT-17209 **\$29⁹⁵**

7-Pc Tamper Resistant Torx[®] Screwdriver Set

- TR8 x 10", TR10 x 10", TR15 x 10", TR20 x 10", T25 x 12-3/4", T27 x 12-3/4", T30 x 12-3/4"

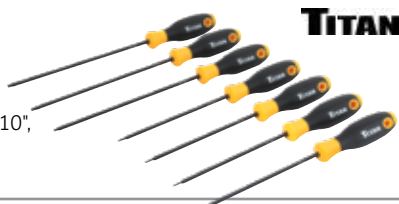

TIT-12346 **\$19⁹⁵**

5-1/2" Multi-Purpose Electrical Shears

- For left and right hand usage
- Micro-serration blades



ATD-4068 **\$79⁹⁵**

3 Lbs. Non-Sparking Hammer with Fiberglass Handle



AME-67301 **\$49⁹⁵**

Nut Buddy Junior - Wheel Nut Remover

- Loosens the most stubborn wheel nuts
- Use on cars and light trucks
- Gear ratio: 18:1
- Rated output torque: 885 ft-lb
- Includes (3) sockets: 17mm, 19mm, 21mm



ATD-74 **\$14⁹⁵**

Storage Box Organizer Set

- Removable trays and dividers for customizable compartments
- Includes (4) individual boxes of varying sizes:
 - (1) 8.66" L x 11.42" W x 2.36" H
 - (1) 8.66" L x 6.1" W x 4.72" H
 - (2) 8.66" L x 6.1" W x 2.36" H



Trex Slip-On Ice Cleats

- One piece traction device for shoes or boots delivers grip and stability

Item #	Size	
ERG-16753	(M) 5-8	\$14.75
ERG-16754	(L) 8-11	\$14.75
ERG-16755	(XL) 11-14	\$14.75

GJO-6420 **\$19⁹⁵**

PURELL[®] ES6 Hand Sanitizer Dispenser - White

- Touch-free dispenser for PURELL[®] ES6 1200 ml hand sanitizer refills
- Dispenser and formulation are calibrated to provide the optimal dose for effective hand hygiene
- Includes 4 "C" cell batteries
- Refill sold separately



GJO-6434 **\$29⁴⁵**

PURELL[®] ES6 Soap Dispenser - Graphite

- Touch-free dispenser for PURELL[®] ES6 1200 ml HEALTHY SOAP[®] refills
- Dispenser and formulation are calibrated to provide the optimal dose for effective hand hygiene
- Includes 4 "C" cell batteries
- Refill sold separately



AUTEL MAXIFLASH

LINK 3-IN-1

COMMUNICATIONS & PROGRAMMING DEVICE



DUAL CHANNELS FOR DATA TRANSFER EFFICIENCY

- Server & Point-to-Point Dual Channel Communication
- Hard-Wired & Wi-Fi Network Communication Modes
- Update Software via Internet Connection



Technicians post orders to the Remote Expert platform via the Autel MaxiFix mobile app



REMOTE PROGRAMMING READY DEVICE

Connect with module programmers, automotive diagnosticians, and system experts for tasks requiring OE data, software, or tools.

J2534 PASS-THRU PROGRAMMER

MULTI-PROTOCOL ENHANCED VCI

Including CAN, CAN FD & DoIP



AUTEL ACADEMY TECHNICAL TRAINING

Visit autel.com/us/academy and register today for hands on automotive diagnostic, repair, service, and ADAS instruction.

AUTEL[®]

AUTEL.COM | FOLLOW US @AUTELTOOLS



PROFESSIONAL TOOLS & EQUIPMENT

Item #	Capacity (Tons)	
TBQ-TAJ40200	40/20	\$1651.85
TBQ-TAJ53150	50/30/15	\$2268.75
TBQ-TAJ60000	60	\$3411.35

NEW



Air/Hydraulic Jacks

Pages 5, 237

NEW

TBQ-17398
21-Pc Master Ball Joint Service Kit

\$170⁴⁵ Pages 5, 368

NEW

TBQ-10330
18-Pc Disc Brake Caliper Tool Kit

\$33³⁵ Pages 5, 340

****While Quantities Last****
FREE 61" TOBEQ Top Chest
with purchase of a matching colour 61" Roller Cabinet.



\$1252⁵⁵

\$2499⁹⁵

HD Series - Top Chests and Roller Cabinets

Page 217

61"



Raised Panel Combination Wrench Sets

Pages 5, 167

NEW

Item #	Kit	Range	
STANDARD Size			
TBQ-5116M	16-Pc	10 - 32mm	\$72.05
TBQ-6014	14-Pc	3/8" - 1-1/4"	\$70.95
JUMBO Size			
TBQ-5110MJ	10-Pc	30 - 42mm	\$141.65
TBQ-6010J	10-Pc	1-5/16" - 2"	\$200.65
TBQ-6004J	4-Pc	2-1/8" - 2-1/2"	\$206.65

CATEGORY Index

A	Abrasives, Cutting & Grinding Accessories 117-125
	Air Compressors & Accessories 108-110
	Air Conditioning System Service 398-408
	Air Tools & Accessories 84-107
B	Battery Service 9-26
	Bearing, Bushing & Seal Service 345-346
	Body Shop 309-320
	Brake Service 338-344
C	Cameras /Videoscopes 70
	Cargo Handling / Hoisting Equipment 248
	Chisels 212-213
	Cooling System Maintenance 372-376
	Cordless & Electric Tools 72-83
	Creepers & Seats 304-306
D	DEF Service & Maintenance 394-395
	Diagnostic & Testing Service Tools 43-69
	Disconnect Tools 410
	Drill Bits, Step Drill Bits, Fastener Extractors 126-131
E	Electric Tools 72-83
	Electric & Hybrid Vehicle Safety Solutions 137-143
	Engine Service Tools 377-388
	Exhaust 307-308

F	Fastener Extractors 129-131
	Flaring Tools 412
	Fluids & Fuel Handling 249-259
	Front-End & Suspension 363-371
	Fuel & Diesel System Service 389-393
G	Grinding Wheels 125
H	Hammers 207-209
	Heat Guns / Flameless Heat Tools / Torches 324-327
	Hoisting Equipment 248
	Hooks & Picks 214
	Hoses & Accessories 111-114
I	Inspection & Pick-Up Tools 71
K	Knives, Scissors & Accessories 135-136
L	Lifting Equipment 234-247
	Lighting 27-42
	Lock-Out Tools & Accessories 396-397
	Lubrication 260-273
M	Measuring & Precision Instruments 334-337
P	Picks 214
	Pick-Up Tools 71

	Pliers 188-206
	PPE (Personal Protection Equip.) 142-143, 274-279
	Pry Bars 210-211
	Pullers 226-233
	Punches & Chisels 212-213
R	Ratchets 144-147
	Riveters 321-323
S	Safety Products / PPE 142-143, 274-279
	Saw Blades & Saws 115-116
	Scrapers 134
	Screwdrivers & Screwdriver Bits 182-187
	Seal Service 345-346
	Seats 306
	Shop Tools, Equipment & Supply 280-303
	Sockets, Bit Sockets & Accessories 148-166
	Soldering Equipment 328-329
	Steering & Suspension Service 363-371
T	Testing Service Tools 43-69
	Thermometers 409
	Threading 132-133
	Tire & Wheel Maintenance 347-362
	Tool Storage & Accessories 215-225
	Torches 326-327
	Torque Tools 178-181
	Tubing & Flaring Tools 411-412
W	Welding & Soldering 328-333
	Wheel & Tire Maintenance 347-362
	Wrenches 167-177